

**DACIA**



**VEHICLE  
USER  
MANUAL**

SPRING ELECTRIC





## Welcome aboard your vehicle

**This user manual** contains the information required:

- for you to familiarise yourself with your vehicle, to use it to its best advantage and to fully benefit from all the functions and the technical developments it incorporates.
- to ensure that it always gives the best performance by following the simple, but comprehensive advice concerning regular maintenance.
- to enable you to deal quickly with minor faults not requiring specialist attention.

It is well worth taking a few minutes to read this manual to familiarise yourself with the information and guidelines it contains about the vehicle and its functions and new features. If certain points are still unclear, our Network technicians will be only too pleased to provide you with any additional information.

For guidance, please see the following symbols:

 and  Visible on the vehicle, they show that you should consult the manual to find detailed information and/or limits on operations in respect of equipment on your vehicle.

→ anywhere in the manual indicates a transfer to a page.



anywhere in the manual indicates a hazard, danger or a safety recommendation.

The description of the models given in this manual is based on the technical specifications at the time of writing. **The manual covers all items of equipment (both standard and optional) available for these models, but whether or not these are fitted to the vehicle depends on the version, the options selected and the country where the vehicle is sold.**

**This manual may also contain information about items of equipment to be introduced later in the model year.**

**The diagrams in the user manual are provided as examples only.**

Enjoy driving your new vehicle.

Translated from French. Copying or translation, in part or in full, is forbidden unless prior written permission has been obtained from the car manufacturer.

# CONTENTS

<b>Welcome aboard your vehicle</b> .....	<b>4</b>	Starting, stopping the engine .....	127
Exterior .....	4	Gear control .....	129
Passenger compartment .....	6	Handbrake .....	132
Driver's position .....	8	Environment.....	133
Driving aids .....	10	Driving advice, eco-driving .....	134
Safety on board .....	12	Tyre pressure loss warning.....	140
Identifying a vehicle - labels .....	14	Driver correction and assistance devices .....	146
The engine compartment (routine maintenance).....	16	Additional driving aid functions .....	149
Breakdown recovery .....	18	Speed limiter.....	173
<b>Getting to know your vehicle</b> .....	<b>20</b>	Cruise control.....	176
Vehicle E-Tech 100% electric (EV).....	20	Parking aids .....	180
Key, remote control.....	47	Emergency call .....	188
Doors and opening elements.....	51	<b>Your comfort</b> .....	<b>191</b>
Engine immobiliser .....	57	Air vents, heating and air conditioning.....	191
Front seats .....	58	Passenger compartment equipment.....	200
Rear seats .....	59	Passenger compartment storage, fittings .....	204
Seat belts.....	61	Transporting objects .....	206
Additional safety devices .....	66	<b>Maintenance</b> .....	<b>209</b>
Child safety .....	75	Accessing the engine, levels .....	209
Child seats .....	80	Battery .....	214
Child safety: deactivating, activating the front passenger airbag .....	92	Cleaning.....	216
Driving position .....	94	<b>Practical advice</b> .....	<b>220</b>
Trip computer .....	100	Tyres .....	220
Warning lights .....	113	Breakdown recovery .....	228
Steering .....	118	Headlights, lights: replacing bulbs .....	231
Rear view.....	119	Wiper blades: replacement .....	235
Lighting and signals .....	120	Fuses .....	237
Audible and visual signals .....	124	Installation and use of accessories.....	239
Wipers.....	125	Operating faults .....	240
<b>Driving</b> .....	<b>127</b>	<b>Technical specifications</b> .....	<b>242</b>

# CONTENTS

Information about the vehicle .....	242
Replacement parts and repairs .....	247
Service sheets .....	248
Anticorrosion check .....	254

# EXTERIOR

1

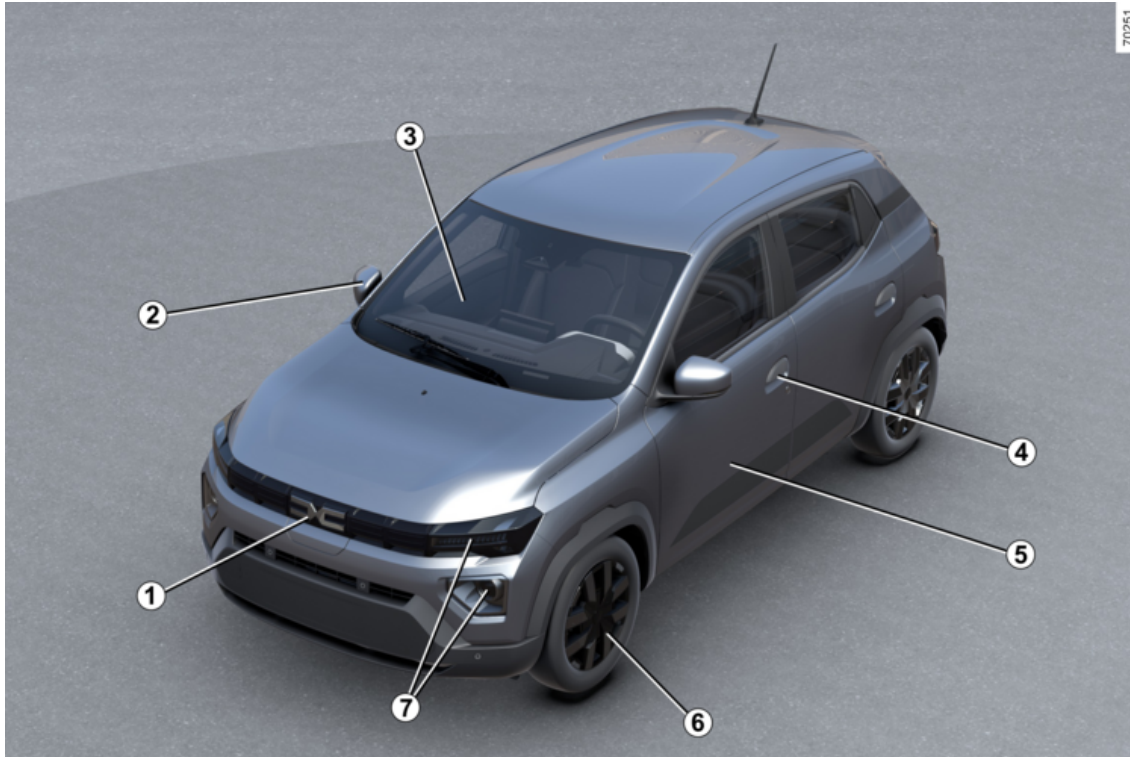

# EXTERIOR

1. Charging → 26

2. Rear view mirror → 119

3. Demisting → 192

Windscreen wipers → 125

Electric windows → 200

4. Key/remote control → 47

Locking/unlocking the doors → 52

5. Bodywork maintenance → 216

6. Tyres → 220

7. Lights : operation → 120

Lights : replacement → 231

# PASSENGER COMPARTMENT

1

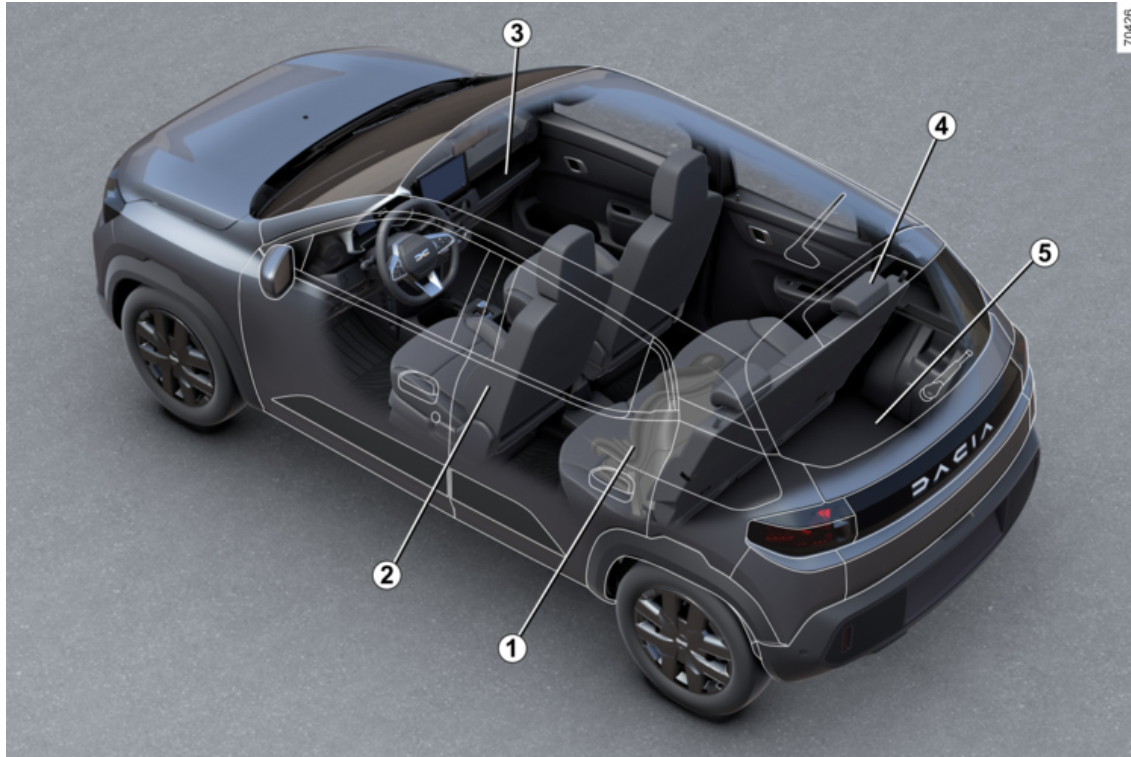

# PASSENGER COMPARTMENT

1. Child safety → 75
2. Front seats → 58
3. Passenger compartment storage/fittings → 204
4. Rear headrests → 59  
Rear bench seat → 59
5. Transporting object in the luggage compartment → 206

# DRIVER'S POSITION

1

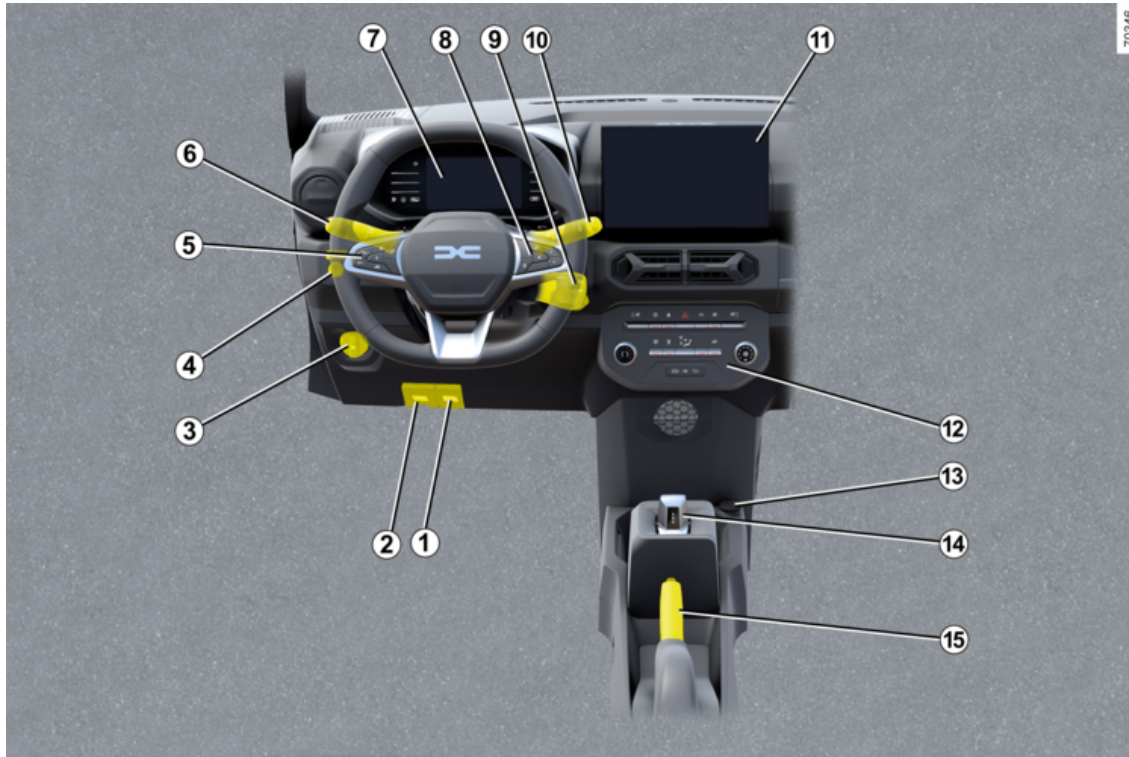

# DRIVER'S POSITION

- 1** Bonnet release → **209**
- 2** Electric charging flap release → **26**
- 3** Headlamp beam adjustment → **121**
- 4** Door mirror adjustment control → **119**
- 5** Speed limiter → **173**
- Cruise control → **176**
- 6** Exterior lighting → **120**
- 7** Instrument panel → **113**
- 8** Trip computer controls → **100**
- 9** Screen wash/wipe stalk → **125**
- 10** Key ignition switch → **127**
- 11** Multimedia screen → **197**
- 12** Controls for:
  - My Safety → **149**
  - mode ECO → **136**
  - Heating/Air conditioning system → **192**
- 13** Accessories socket → **202**
- 14** Driving mode selector → **129**
- 15** Hand brake → **132**

# DRIVING AIDS

1

70440



## DRIVING AIDS

- ABS (anti-lock braking system) Braking assistance → 146
- ESC (electronic stability control) → 146
- Braking assistance → 147
- Hill start assistance → 146
- Traction control → 146
- My Safety → 149
- Lane departure prevention → 150
- Active emergency braking → 158
- Driver vigilance warning → 166
- Road sign detection → 168
- Speed limiter → 173
- Cruise control → 176
- Parking distance control → 180
- Reversing camera → 185
- Tyre pressure loss warning → 140

# SAFETY ON BOARD

1

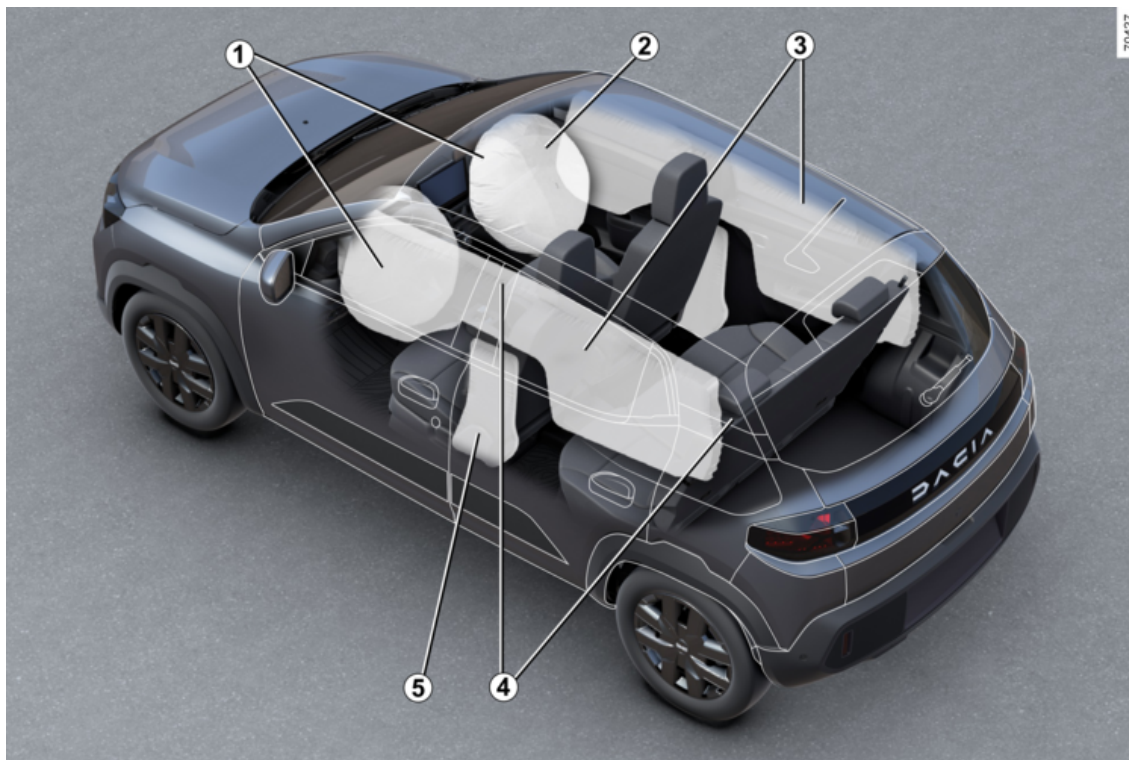

# SAFETY ON BOARD

- 1 Airbags Front → 66
- 2 Deactivating the passenger's front airbag → 92
- 3 Airbags Curtain → 71
- 4 Seat belts → 61
- 5 Airbags side → 71

# IDENTIFYING A VEHICLE - LABELS

1

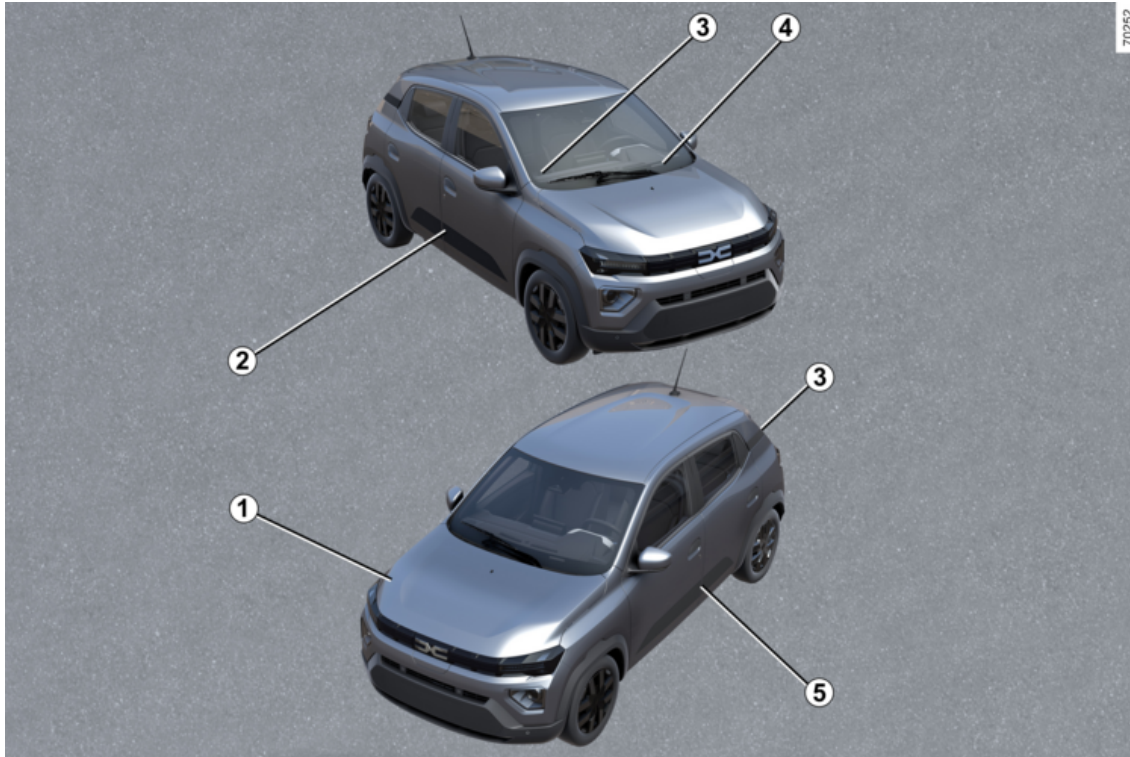

## IDENTIFYING A VEHICLE - LABELS

- 1 Engine identification → 242
- 2 Vehicle identification plate → 242
- 3 Technical information for the emergency services → 243
- 4 Review of a vehicle identification number → 242
- 5 Tyre pressure label → 222

# THE ENGINE COMPARTMENT (ROUTINE MAINTENANCE)

1

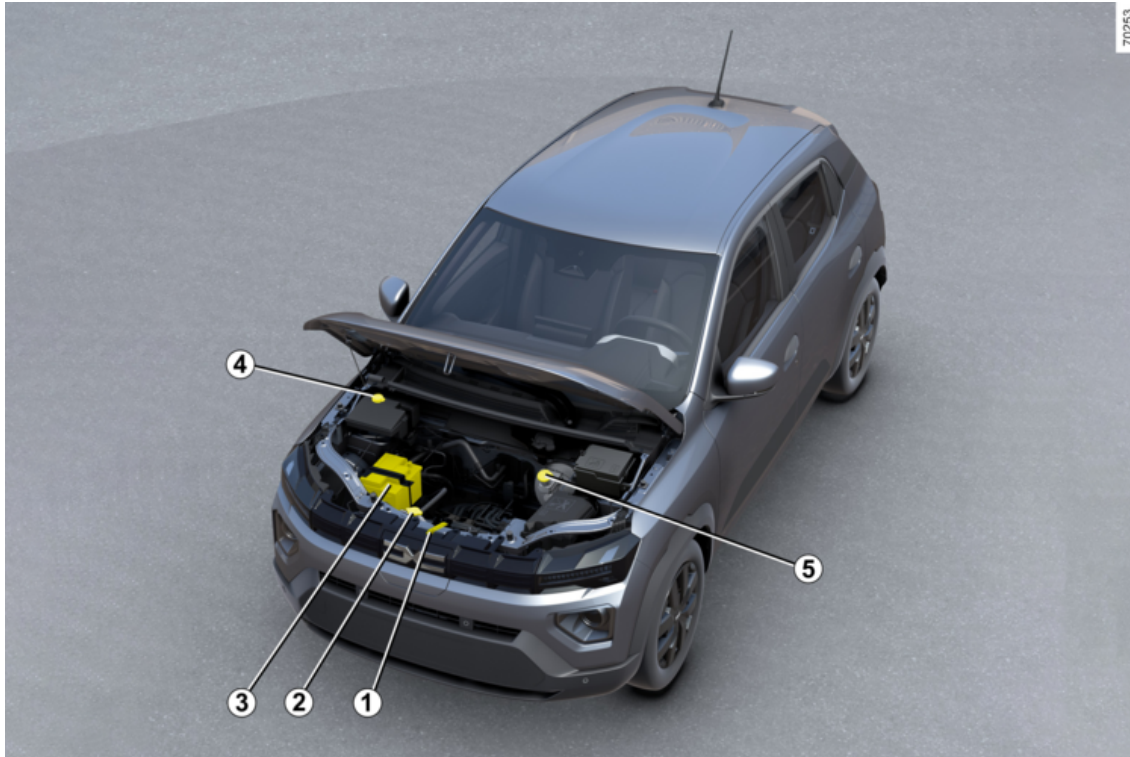

# THE ENGINE COMPARTMENT (ROUTINE MAINTENANCE)

- 1 Opening the bonnet → 209
- 2 Coolant level → 211
- 3 Secondary 12 V Battery → 214
- 4 Windscreen washer fluid → 125
- 5 Brake fluid → 212
- 6 260V electric circuits → 20

# BREAKDOWN RECOVERY

1

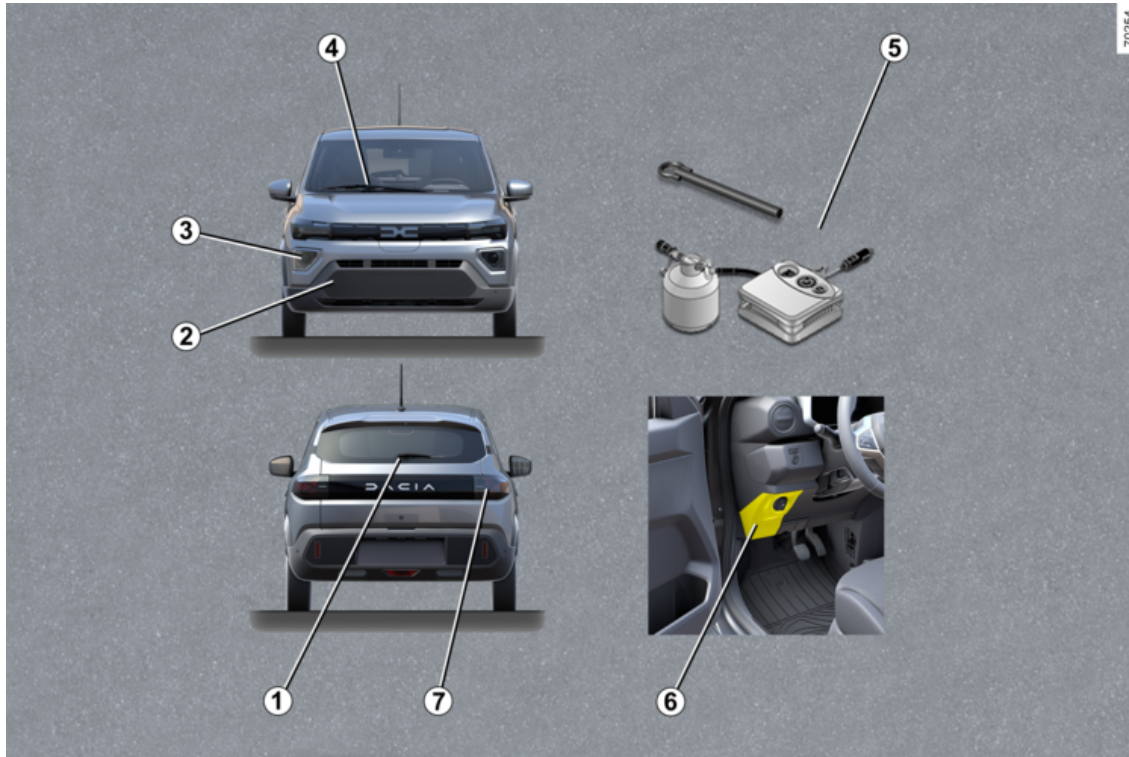

## BREAKDOWN RECOVERY

- 1 Replacing rear screen wiper blade → 235
- 2 Front towing point → 228
- 3 Replacing headlight bulbs → 231
- 4 Replacing windscreen wiper blade(s) → 235
- 5 Tools → 223
- 6 Fuses → 237
- 7 Replacing rear lights → 232

# VEHICLE E-TECH 100% ELECTRIC (EV)

## Introduction

2

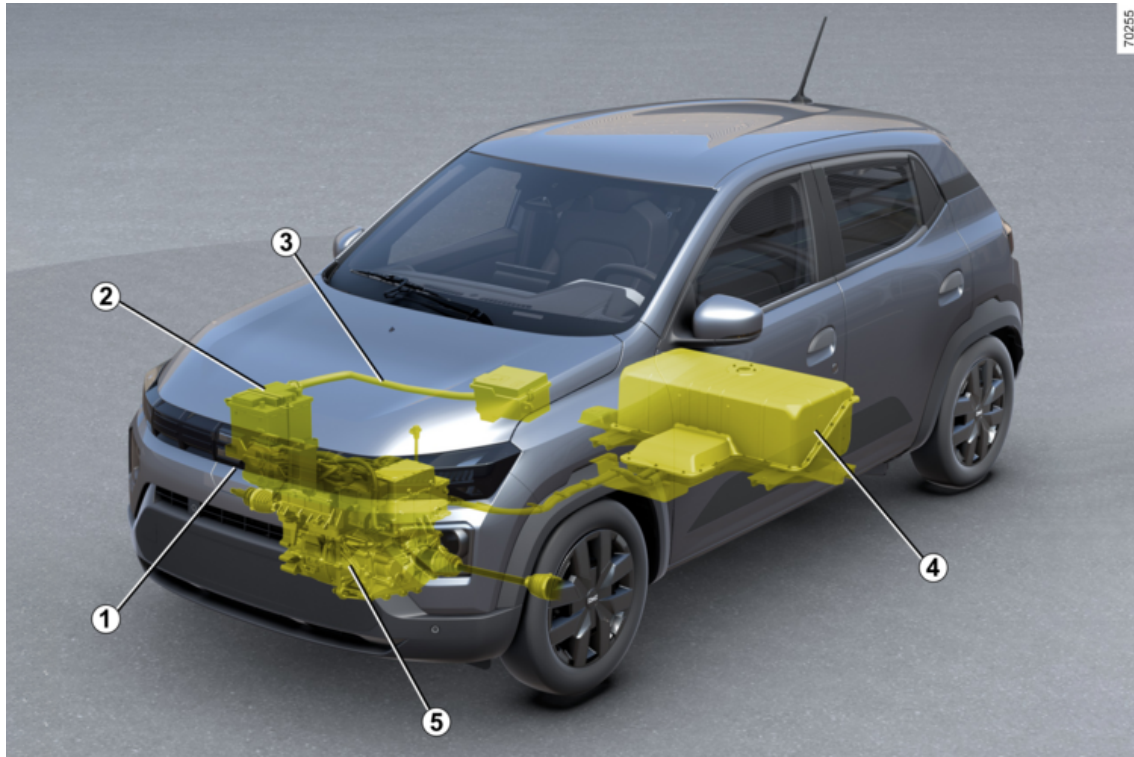

# VEHICLE E-TECH 100% ELECTRIC (EV)

- 1 Electric charging connection
- 2 Secondary « 12 V » battery
- 3 Orange electrical power cables
- 4 « 260 V » traction battery
- 5 Electric motor

Electric vehicles have special features, but operate in a similar manner to conventional vehicles.

The main difference in electric vehicles is the exclusive use of electric energy instead of fuel, as used in conventional vehicles.

We therefore recommend that you read these instructions describing your electric vehicle carefully.

## Connected services



(depending on the vehicle)

Your electric vehicle has connected services that provide information and/or control:

- your vehicle's charging status with low battery warning;
- the traction battery charging programming, based on certain choices on offer;
- remaining vehicle range;
- ...

You can access these services by:

- external digital devices (mobile telephones **6**, tablets **7** etc.) ;

For more information, refer to the multimedia equipment instructions or contact an Approved Dealer.



You can subscribe to a connected service or extend it at any time by consulting an authorised dealer.

## Batteries

Your electric vehicle has two types of battery :

- a « 260 V traction battery » ;
- secondary « 12 V » battery.

### « 260 V » traction battery

This battery stores the energy necessary to operate the motor in your electric vehicle properly. As with any battery, it discharges after use, and must be regularly recharged.

You do not have to wait until the traction battery hits the reserve level in order to recharge it.

Charging times vary depending on the type of specific wall unit socket or public terminal you connect to.

Your vehicle range will depend on the charge level of the traction battery, and also on your driving style ➔ **137**

### Secondary « 12 V » traction battery

## VEHICLE E-TECH 100% ELECTRIC (EV)

The second battery on your vehicle is a secondary « 12 V » battery: this supplies the energy required to operate vehicle equipment (lights, windscreen wipers, ABS, etc).

2

A



The **A** symbol denotes the electrical elements of your vehicle which may present health risks.

61607

### « 260 volt » electrical circuit

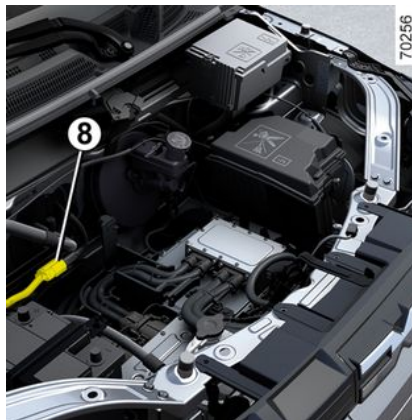

The « 260 V » electrical circuit is denoted by orange cables **8** and parts

bearing the  symbol.



The vehicle drive system in an electric vehicle uses a direct voltage of approximately « 260 V ».

This system can get hot during and after switching off the ignition. Respect warning messages given on the labels in the vehicle.

All interventions or modifications to the « 260 V » electrical system (components, cables, connectors, traction battery) are strictly prohibited due to the risks they present to your safety. Please contact an authorised dealer.

**The risk of serious burns or electric shocks can lead to death.**

### Driving

As with a car with a sequential gear-box, you will have to get used to not using your left foot, and not using this foot to brake.

When driving, if you lift your foot off the accelerator pedal or depress the brake pedal, the motor generates electrical current during deceleration, and this energy is used to brake the vehicle

## VEHICLE E-TECH 100% ELECTRIC (EV)

and recharge the traction battery  
➔ 100.

### Special feature

After a maximum charge of the battery and during the first few miles of using the vehicle, the engine brake will be temporarily reduced. Please adapt your driving style appropriately.

Bad weather, flooded roads.



Do not drive through floods if the depth of water is above the lower edge of the wheel rims.

### Noise

Electric vehicles are particularly quiet. You will not yet necessarily be used to it, and neither will other road users. It is difficult for them to hear the vehicle when it is moving.

As the motor is silent, you will hear noises that you are not used to hearing (aerodynamic noises, tyre noise, etc.). When charging, the vehicle may emit noises (fan, relays, etc.).

When the vehicle is stopped, the heating system may start automatically for self-maintenance.

### Pedestrian Horn

The pedestrian horn enables you to warn others of your presence – especially pedestrians and cyclists.

When the engine is started, the pedestrian horn is activated automatically. The sound is triggered when the vehicle speed is between about 1 and 20 mph (1 and 30 km/h) ➔ 124.



Your electric vehicle is silent. When getting out of the vehicle, always check that the gear selector is in **N** position, apply the parking brake and switch off the ignition.

**RISK OF SERIOUS INJURY.**



### Obstructions to the driver

On the driver's side, only use mats suitable for the vehicle, attached with the pre-fitted components, and check the fitting regularly. Do not lay one mat on top of another.

**There is a risk of wedging the pedals.**



The engine brake should under no circumstances be used as a substitute for the brake pedal.

# VEHICLE E-TECH 100% ELECTRIC (EV)

## Important recommendations

2



Please read these instructions carefully. Failure to follow these instructions may lead to a **risk of fire, serious injury or electric shock which may present a risk to life.**

### **In the event of an accident or impact**

In the event of an accident or an impact to the underside of the vehicle (e.g. : striking a post, raised kerb or other street furniture), this may damage the electric circuit or the traction battery.

Have the vehicle checked by an authorised dealer.

Never touch the « 260 volt » components or orange cables which are exposed and visible inside or outside the vehicle.

In the event of serious damage to the traction battery, leaks may occur :

- never touch the liquids (fluids, etc.) coming from the traction battery ;
- in the event of contact with the body, wash the affected area with plenty of water and consult a doctor as soon as possible.

In the event of an impact, even slight, against the charging flap and/or valve, have them checked by an authorised dealer as soon as possible.

### **In the event of fire**

In the event of fire, make everyone evacuate the vehicle immediately and contact the emergency services, informing them that this is an electric vehicle.

Only use extinguishing agents ABC or BC that are permitted for use with electrical fires. Do not use water or other extinguishing agents.

In the event of damage to the electrical circuit, please call an authorised dealer.

### **All towing operations → 228**

### **Washing the vehicle**

Never wash the engine compartment, the charging connection or the traction battery with a high-pressure jet.

**This risks damaging the electric circuit.**

Never wash the vehicle while it is charging.

Never wash the charging lead while the vehicle is charging.

Never wash the charging lead, even while the lead is not connected, in order to prevent corrosion of the charging pins.

## VEHICLE E-TECH 100% ELECTRIC (EV)

**Risk of electric shock and a risk to life.**

2

# VEHICLE E-TECH 100% ELECTRIC (EV)

## Charging

2

### Schematic diagram

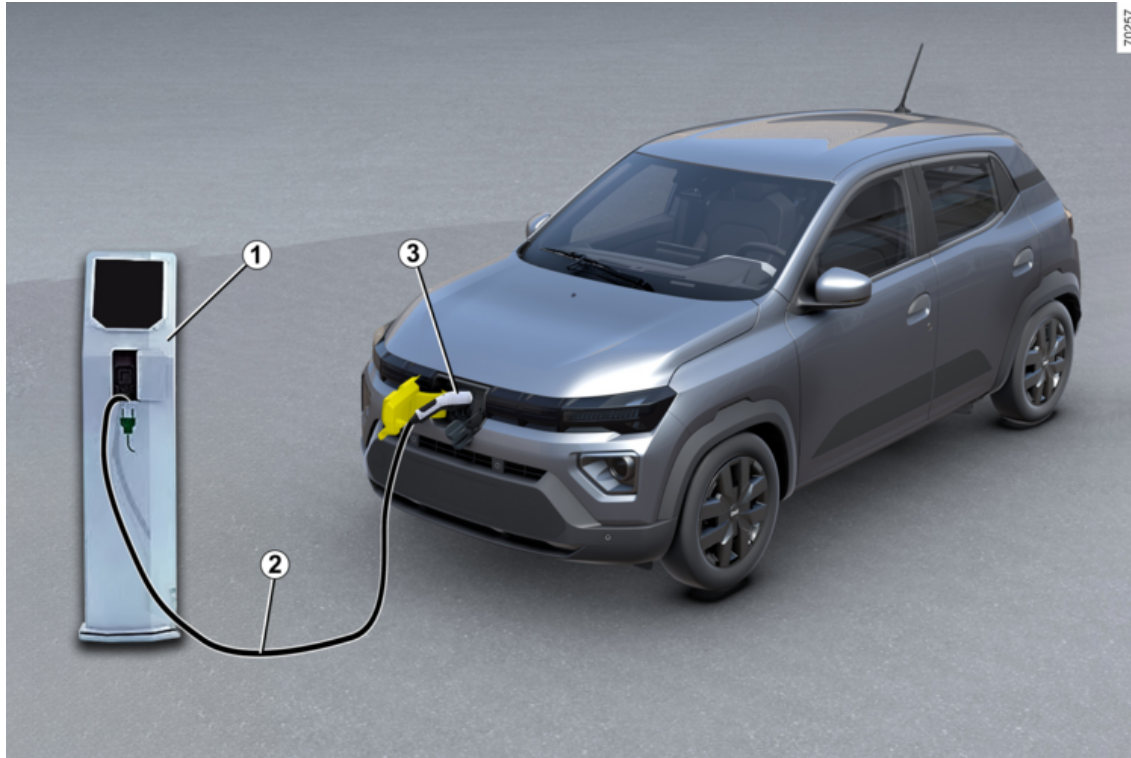

# VEHICLE E-TECH 100% ELECTRIC (EV)

- 1 Specific wall socket or recharging terminal
- 2 Charging cord
- 3 Electric charging connection

2



If you have any questions regarding the equipment needed for charging, please ask an authorised dealer.



## Important recommendations for charging your vehicle

Please read these instructions carefully. Failure to follow these instructions may lead to a **risk of fire, serious injury or electric shocks which could result in death.**

### Charging

Do not do anything to the vehicle during charging (washing, working in the engine compartment etc.).

In the event of the presence of water, signs of corrosion or foreign bodies in the charging cord connector or in the vehicle charging socket, do not charge the vehicle. Fire hazard.

Do not attempt to touch the cord contacts, the domestic socket or the vehicle charging socket, or introduce objects into them.

Never plug the charging cord into an adapter, multiple socket or extension lead.

The use of generators is prohibited.

Do not remove or change the vehicle charging socket or the charging cord. Fire hazard.

Do not modify or perform any action on the installation during charging.

In the event of an impact, even slight, against the charging flap or the electric charging connection with charging cord plugged, have them checked by an authorised dealer as soon as possible.

Take care of the cord : do not tread on it, immerse it in water or pull on it or let anything knock against it.

Check regularly that the charging cord is in good condition.

In the event of damage to the charging cord (corrosion, browning, cuts, etc.), to the unit or to the vehicle's electrical charging socket, do not use them. Please see an authorised dealer to replace them.

In the event of non-activation of the charging flap locking mechanism and/or unlocking of the vehicle's electric charging socket, please contact an approved dealer.

# VEHICLE E-TECH 100% ELECTRIC (EV)

## Charging cord A

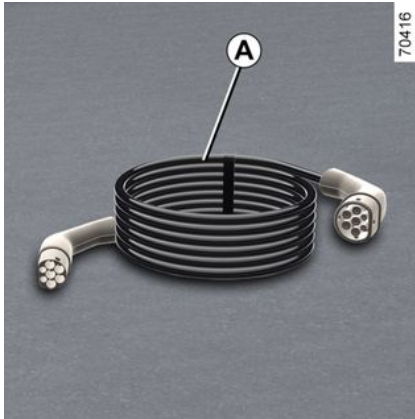

This cord is specific to your vehicle and designed for connecting to wall sockets or public terminals to enable standard charging of the traction battery.

**i** We recommend that you use a charging cord that enables a standard charge to charge the traction battery.

**i** Each charging cord is stored in the luggage compartment of the vehicle.

**i** Before cleaning the charging lead, make sure the lead is disconnected. Clean the cable using a cloth slightly dampened with water. When cleaning, make sure that the cloth does not come into contact with the ends of the cable (connectors, charging pins) to avoid any risk of corrosion.

## Charging cord B

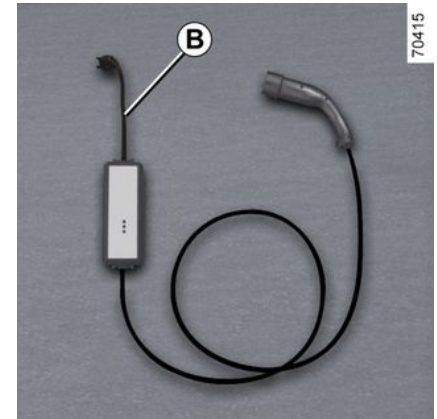

This cord allows charging on a domestic socket (8A/10A charge).

Sockets must be fitted as stated in the instruction supplied with the charging cord **B**.

## VEHICLE E-TECH 100% ELECTRIC (EV)

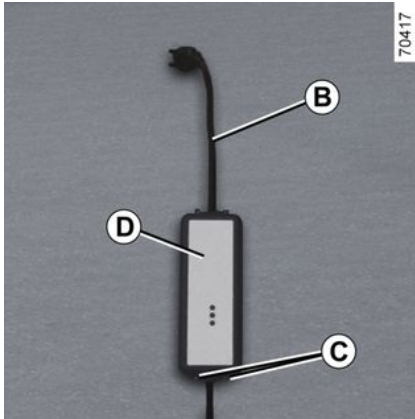

Always read the charging cord instructions **carefully** before using it **B**.



Never leave the socket hanging by the cord. Use the hooks **C** to attach it



If a charging cord malfunctions during the charging process (red warning light on the unit **D**), stop charging immediately. Please refer to the cord instructions.

# VEHICLE E-TECH 100% ELECTRIC (EV)

## Important recommendations

2



### **Important recommendations for charging your vehicle**

Please read these instructions carefully. Failure to follow these instructions may lead to a **risk of fire, serious injury or electric shocks which could result in death.**

#### **Choice of charging cord**

The standard charging cords supplied with the vehicle have been designed specifically for this vehicle. It is designed to protect you against the risks of electric shock that can lead to death or fire.

Do not use with the charging cord of previous vehicles as they are not adapted.

For safety reasons, the use of a charging cord not recommended by the manufacturer is strictly forbidden. Failure to follow this instruction can lead to risks of fire or electric shock that can prove fatal. For information on a charging cord suited to your vehicle, please consult an authorised dealer.

#### **Using the charging cord B**

Please read the instructions that come with the charging cord carefully to learn about precautions you must take when using the product and the technical specifications required when fitting the socket.

#### **Installation**

##### **Wall socket**

Have a special wall socket installed by a qualified professional.

##### **In the case of domestic charging**

Have a qualified professional check that each socket to which you will connect the charging cable complies with the standards and regulations in force in your country and that it complies with the specifications described in the information on « Power supply systems ».

##### **Power supply systems**

Only use charging terminals which conform to the IEC 61851-1 standard and connecting points protected by :

- a Type A 30 mA residual current device specific to the socket used;
- an overcurrent protection device;
- protection against overvoltage relating to lightning in exposed areas (IEC 62305-4);
- an earth connection that complies with the standards in the relevant country.

# VEHICLE E-TECH 100% ELECTRIC (EV)

Charging types that conform to European standards

Alternating current (AC)

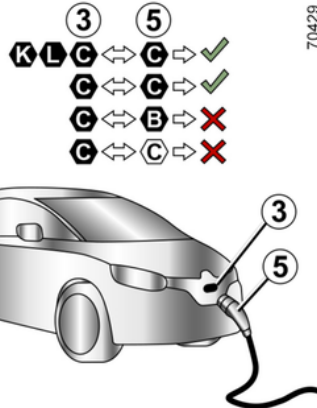
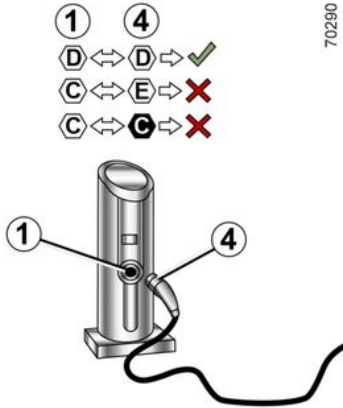

If the information is displayed on the vehicle charging flap, follow the instructions below.





Before plugging in a charging cord, check that:

- the colour and one of the letters of the inlet socket **1** correspond to the colour and one of the letters on the end **4** of the cord;
- the colour and one of the letters of the inlet socket **3** correspond to the colour and one of the letters on the end **5** of the cord.

# VEHICLE E-TECH 100% ELECTRIC (EV)

## Labels

2

Charging type	Alternating current ( AC )				
Connection	Charging terminal 1 /Charging cord 4			Vehicle 3 /Charging cord 5	
<b>Charging types that conform to European standards</b> (for all other cases, please consult an approved dealer).					

# VEHICLE E-TECH 100% ELECTRIC (EV)

## Charging types that conform to European standards

### Direct current (DC)

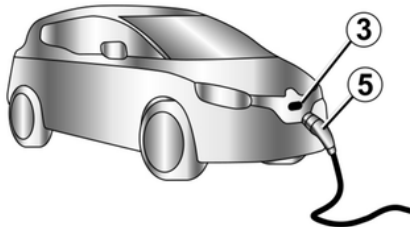
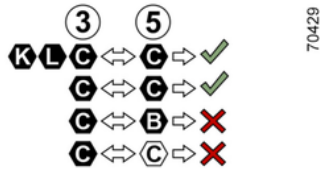





If the information is displayed on the vehicle charging flap, follow the instructions below.

Before plugging in a charging cord, make sure that the colour and one of the letters of the inlet socket **3** correspond to the colour and one of the letters on the end **5** of the charging cord.

# VEHICLE E-TECH 100% ELECTRIC (EV)

## Labels

2

<b>Charging type</b>	<b>Direct current ( DC )</b>				
<b>Connection</b>	<b>Vehicle 3 /Charging cord 5</b>				
<b>Charging types that conform to European standards</b> (for all other cases, please consult an approved dealer).					

# VEHICLE E-TECH 100% ELECTRIC (EV)

## Electric Charging connection 3

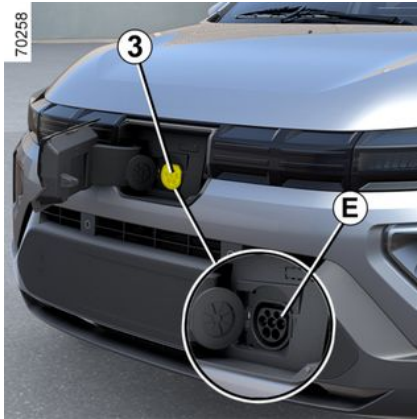

**Note:** If in a snowy environment, remove snow from the vehicle charging area before plugging in or disconnecting. Snow in the socket may block the insertion of the charging cord plug.

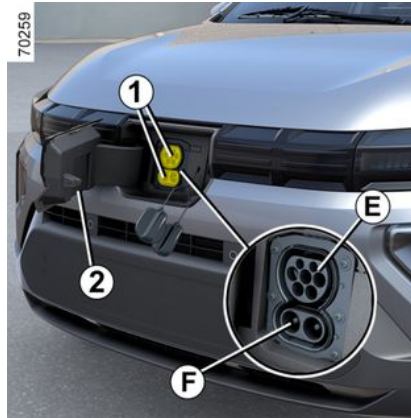

The vehicle is equipped with two charging connections located at the front of the vehicle :

- **E** socket for charging up to **7 kW** in alternating current (AC) ;
- **F** socket depending on the vehicle, for rapid charging in direct current (DC).

**i** Depending on the vehicle, **E** and **F** sockets are protected by plugs. Before connecting a charging cord :

- on **E** socket, make sure that the plug on **F** socket is in place ;
- on **F** socket, remove the plug from **E** socket.

### Precautions

For daily use, it is recommended that you charge your vehicle to 80% to improve the battery service life.

Avoid charging and parking your vehicle in extreme temperatures (hot or cold).

Under extreme conditions, charging may take several minutes before starting (time required for the traction battery to cool down or warm up).

When the vehicle is parked for more than seven days in temperatures below approximately  $-25^{\circ}\text{C}$ , charging the traction battery can become impossible.

When the vehicle is parked for more than three months with near zero charge, charging the battery can become impossible.

## VEHICLE E-TECH 100% ELECTRIC (EV)

The energy level available depends on the battery temperature. It may therefore vary between stopping and restarting the vehicle if the battery is cold or warm.

To preserve the service life of your traction battery, avoid parking the vehicle for more than one month with high charge, especially when the weather is very hot.

Favour charging the traction battery after driving and/or in mild temperatures. Otherwise, charging may take a longer period of time or even become impossible.

It is preferable to recharge the vehicle after driving if the charge level is low (< 25%) and in negative temperatures.

### Recommendations

- in high temperatures, try to park and recharge the vehicle in a shaded/ covered location ;
- charging can be performed in the rain or snow ;
- activating the air-conditioning increases the charge time required.



In the absence of any protection against overvoltage, you are recommended not to charge the vehicle in stormy weather (lightning, etc.).



Do not use an extension cord, multiple socket or adapter.

**Fire hazard.**

### Recharging the traction battery

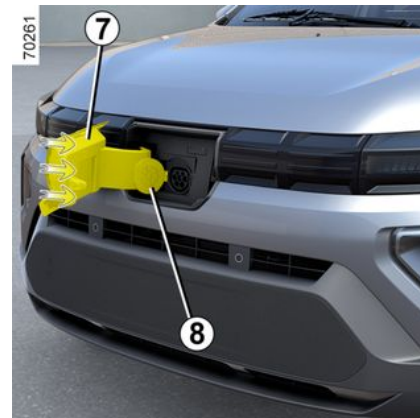

### Vehicle stationary, opening element unlocked, ignition off:

- take the charging cord located in the boot of your vehicle;
- pull the **6** button to unlock the charging flap **7**. If the charging flap **7** not opening after pull the **6** button due to icing, recommending to hit the flap on the mentioned zone/direction by the hand to remove ice and try again;
- remove cap **8**. Plug in the end of the cord to the power supply;
- grab the handle **9**;
- plug in the vehicle cord.

## VEHICLE E-TECH 100% ELECTRIC (EV)

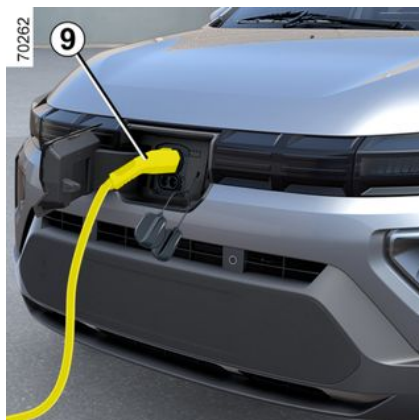

- check that the charging cord is properly plugged in. Before the charging starts, the plug lock will be active;
- the charging cord is automatically locked with the vehicle. This will make it impossible to unplug the cord from your vehicle.

**Note :** do not pull on the handle **9** during the locking of the charging cord to the vehicle.

**i** Make sure that the hand brake is applied always whenever the vehicle is in charging condition.

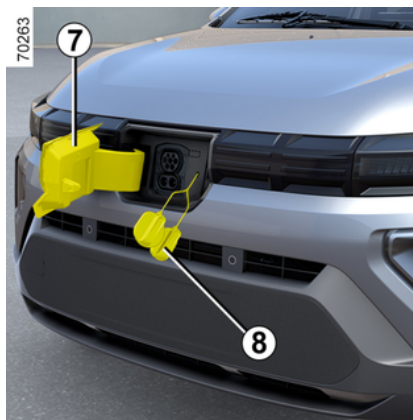

**i** If rapid charging (DC) the length of the charging cord between your vehicle and the charging station must not exceed **30 metres**.

In case of doubt about the length of the cord, consult the owner of the charging station (DC).

**i** Make sure you fully uncoil the charging cord to limit its heating.

When charging starts, the following information is displayed on the instrument panel:

- the energy level on the battery warning light **11**;

2

## VEHICLE E-TECH 100% ELECTRIC (EV)

2

 The traction battery charging time depends on the amount of energy remaining and the power delivered by the charging terminal. The information is displayed on the instrument panel during charging → **106**.

**Note:** under certain conditions, the actual charging time may be longer than the charging time displayed on the instrument panel. This depends on:

- the quality of the electrical network;
- the initial charge level;
- the exterior temperature is too cold;
- ...

In the event of a problem with the charging cable, we recommend that you replace it with a cable that is identical to the original. Consult an approved dealer.

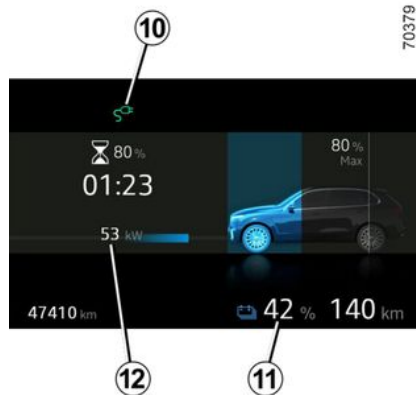

70379

- the battery refill rate;
- an estimate of the remaining charging time (this is not displayed after the battery is charged to approximately 95%);
- the warning light **10** indicates that the vehicle is connected to a power supply;
- the power supply entering the vehicle **12**;
- your vehicle range will vary according to the charge level.

The display on the instrument panel disappears after a few seconds. It reappears on the instrument panel when a door is opened.

Once charging is complete, the warning light **10** illuminates continuously in green.

You do not need to wait until the charge is at reserve levels to recharge your vehicle.

### Operating faults

If the warning light **10** blinks continuously in red, please contact an approved dealer.

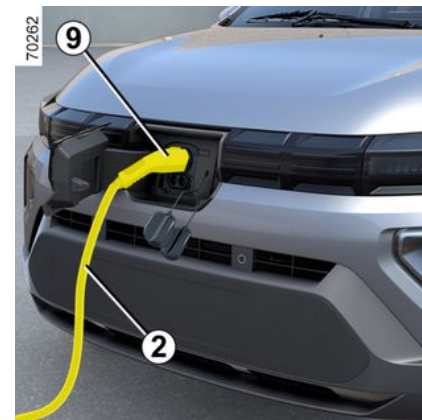

### Precautions to take when removing from socket;

It is imperative to follow the unplugging steps in order:

- to unlock the vehicle charging cord and stop charging;

## VEHICLE E-TECH 100% ELECTRIC (EV)

– press the operating elements unlocking button on the remote control key;

or

– press the interior locking and unlocking door control → 52;

– grab the handle **9** and unplug the charging cord from the vehicle ;

– put cap **8** back ;

– close the charging flap **7** with both hands and press on it in order to lock it ;

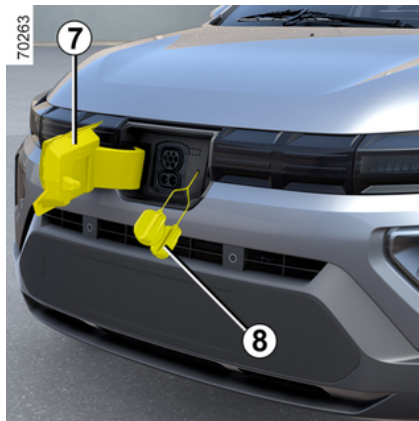

– unplug the cord from the power supply;

– place the cord **2** in the luggage compartment.

**Note:**

– Immediately after a long charge of the traction battery, the cord may be hot. Please use the handles.

– depending the situation, if the vehicle charging cord is still locked after pressing the unlocking button on the remote control, repeat the operation by pressing the unlocking button **twice consecutively**. One, to stop the charge and one to allow the unlocking of the handle **9**.

**Label 13**

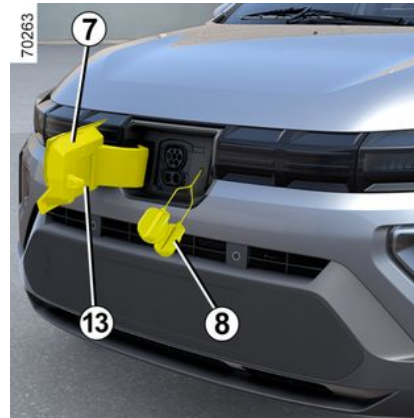

70418

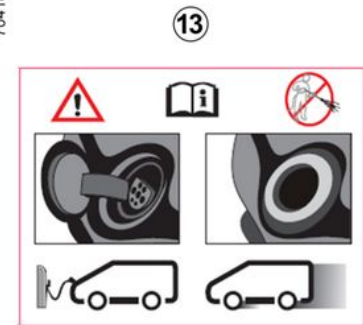

The label **13** located on the right-hand side reminds you of the following instructions:

- do not wash the charging flap using a high-pressure water jet;
- with the vehicle stationary, the valve and the charging flap can be opened;
- when the vehicle is being driven, the valve and the charging flap must be closed;
- open the flap to connect the charging lead;
- close the flap again once disconnected;
- connect to a domestic socket, an alternating current charging terminal or a quick charging terminal;

## VEHICLE E-TECH 100% ELECTRIC (EV)

– For any information on charging, please consult your vehicle user manual.

**i** Do not drive the car with the charging flap **7** open condition. Once the charging cord is unplugged from the vehicle, make sure that the cap **8** is put and the charging flap **7** is properly closed.

**i** At the end of charging, unplug the cord from the vehicle first, before unplugging it from the domestic socket.

**i** After pressing the unlocking button on the radio frequency remote control or the interior locking/unlocking door control ➔ **52**, you have 30 seconds to unplug it before it locks again and charging resumes.

**i** The traction battery charging time depends on the amount of energy remaining and the power delivered by the charging terminal. The information is displayed on the instrument panel during charging ➔ **106**.

In the event of a problem, we recommend that you replace it with an identical cord. Please see an authorised dealer.

**i** **In alternative current (AC) charging mode**

– depending on the charging station, remote charge stop and resume function possible during a charge;  
– the charging can be stopped and the charging plug unlocked by pressing the unlock button in the radio frequency key or by pressing the interior locking/unlocking door control ➔ **52**.

**i** **In direct current (DC) charging mode**

– depending on the vehicle and the charging station, remote charge stop possible but resume function not possible during a charge;  
– the charging can be stopped and the charging plug unlocked only with the recharging terminal. By pressing the unlock button of the radio frequency key or by pressing the interior locking/unlocking door control ➔ **52**, the charging will not get stopped.

# VEHICLE E-TECH 100% ELECTRIC (EV)

## Charging programming

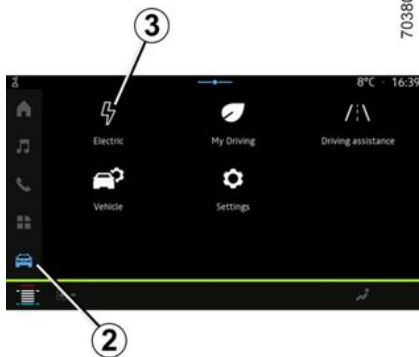

With the vehicle stationary and the engine on, from the « Vehicle » world **2**

on the multimedia screen **1**, press the « Electric » menu **3** then the « Charging » tab to programme your vehicle charging.

You can choose from several charging modes:

- « Immediate charging »;
- « Programme ».

Please refer to the multimedia instructions for further information.



For safety reasons, carry out these operations when the vehicle is stationary.

When the programming is confirmed,

the indicator light  lights up on the instrument panel.

**Note:** charging will start if the engine is switched off, the vehicle is connected to a power supply and access is authorised.



If you have just accepted a system update via the multimedia system, the traction battery charging will be delayed or cancelled.

Wait for the update to be completed before connecting the charging lead to the vehicle.

For more information on system updates, please refer to the multimedia instructions.

## Vehicle to load function

Vehicle stationary and parking brake applied, the Vehicle to Load (V2L) function allow you to connect electronic devices directly to the vehicle.

The system provides AC power (up to 16 A/3,7 kW) using the stored electricity energy in the traction battery of your vehicle → **20**.

The V2L connector let you plug and operate various electric devices to the charging socket on the front of your vehicle.

# VEHICLE E-TECH 100% ELECTRIC (EV)

## Important Recommendation

2



Please read these instructions carefully. Failure to follow these instructions may lead to a **risk of fire, serious injury or electric shock which may present a risk to life.**

### **Precautions when using the V2L function**

Do not try to supply electricity to the house as this can expose to damages and electrical shock.

Do not do wash the vehicle or work in the engine compartment when using the V2L function.

Do not use the V2L function:

- In the event of the presence of water in the V2L connector or in the vehicle charging socket;
- If V2L connector or vehicle socket are damaged (broken, corrosion, browning, etc.), please see an approved dealer to replace them;
- outdoors if weather conditions are not favorable (rain, risk of lightning, etc.).

Do not place any metal objects on the V2L connector.

Do not modify or perform any action on the V2L connector during using V2L function.

Never plug an adapter on the V2L connector.

### **Precautions for handling and using the V2L connector.**

Only use the V2L connector supplied with the vehicle. The V2L connector have been designed specifically for this vehicle.

For safety reasons, the use of a V2L connector not recommended by the manufacturer is strictly forbidden. For information on V2L connector suited to your vehicle, please consult an approved dealer.

Do not place any objects on the V2L connector and do not hang devices by their power cable from the AC output socket on the V2L connector. **Risk of damage.**

Take care of the V2L connector: do not remove it, do not immerse it in water, pull on it when it is plugged in, or let anything knock against it. Check regularly that the V2L connector is in good condition.

### **Precautions when using electric/ electronic products.**

Before connecting and using a product (appliance, extension lead, power strip, etc.), check the precautions for use by referring to its instructions.

Do not connect:

- devices that require a continuous power supply, such as medical equipment. The power supply may be interrupted depending on vehicle operation;

## VEHICLE E-TECH 100% ELECTRIC (EV)

- devices that draw more than 16 A;
- devices that are not compliant with national regulations and standards.
- damaged devices (casing, cables, etc.);
- devices for which the initial recommendations for use are not adapted to the environment in which they are used (risk linked to the penetration of dust and water);
- more than one multi-socket. When using it, do not connect products that consume more than 8 A;
- an extension lead longer than 20m. When using it, be sure to unroll it completely.

# VEHICLE E-TECH 100% ELECTRIC (EV)

## V2L connector A

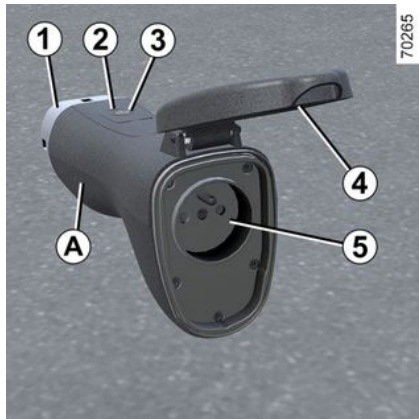

1. Charging socket
2. Operating indicator light
3. Start/Stop switch
4. Protective cover
5. AC outlet socket

The V2L connector is stored with tools kit underneath the boot carpet.

 To maintain the V2L connector, make sure it is unplugged. Clean the connector with a cloth slightly dampened with water. When cleaning, make sure that the cloth does not come into contact with the ends of the V2L connector (outlets, charging pins) to avoid any risk of corrosion.

### Operation



Make sure that the parking brake is applied always whenever the V2L function is used.

 It is imperative to follow the plugging/unplugging steps of the V2L connector in order.

 Before connecting or disconnecting a device, make sure that indicator light 2 on connector V2L connector is off.

### To connect the V2L connector

Vehicle stationary, opening element unlocked, ignition off:



pull the button **6** to unlock the charging flap **9**;

## VEHICLE E-TECH 100% ELECTRIC (EV)

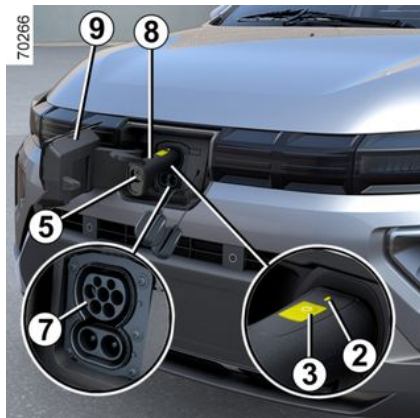

- remove cap from the charging inlet of the vehicle **7**;
- grab the connector handle **8** and plug the end **1** of the connector into the vehicle charging inlet **7**;
- check that the V2L connector is properly plugged in by pulling gently on the handle **8**. Before the discharging starts, the plug lock will be active. The V2L connector is automatically locked with the vehicle. This will make it impossible to unplug the connector from the power supply of your vehicle;
- plug the electric appliance or electric device to the AC outlet **5**;
- press the switch **3** of the V2L connector for more than three seconds

until the indicator light **2** turned on green. The V2L function is activated and the electrical appliance is supplied with power.

**NOTE:** do not pull on the handle **8** after the locking of the V2L connector to the vehicle.

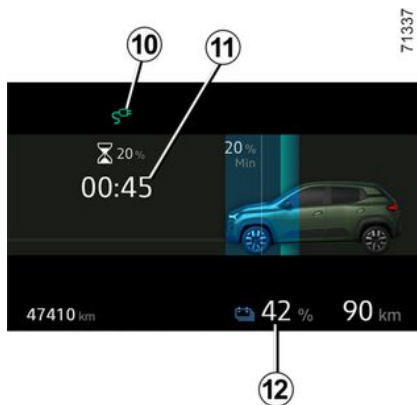

When using, the following information is displayed on the instrument panel:

- the warning light **10** to show that the vehicle is connected to the V2L connector;
- an estimate of the time remaining **11** before the low battery charge level is reached;
- the battery energy level **12**.

**Note:** the energy supply stops automatically when:

- the V2L function is not used for approximately one hour (no electrical appliances connected to the AC socket **5** of the V2L connector or no power consumption);
- an electrical appliance exceeding the maximum power supply capacity is connected;
- when the doors have been locked beforehand, the driver's door is unlocked;
- when the minimum traction battery charge threshold set on the multimedia screen is reached.

When the power is switched off, a message is displayed on the instrument panel to inform you.

### To disconnect the V2L connector

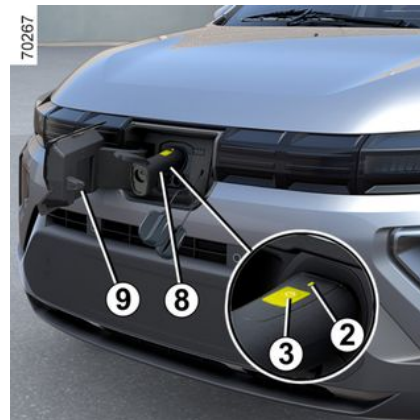

## VEHICLE E-TECH 100% ELECTRIC (EV)

### If opening element of the vehicle are locked:

- press the unlock button in the remote-control key → **47**.
- or
- press the unlock button on the central console → **53**.
  - **vehicle unlocked**, press the switch **3** of the V2L connector for more than three seconds to stop the discharge. The light **2** goes out and the V2L function is deactivated.
  - the V2L connector is automatically unlocked with the vehicle. This will allow to unplug the connector from your vehicle;
  - Unplug your device and grab the connector handle **8** of the V2L connector to disconnect it from the vehicle **within approximately 15 seconds**. Otherwise, the charging socket **7** will be locked again automatically.
  - replace the cap of the charging inlet of the vehicle and close the charging flap **9**.
  - place the V2L connector in its storage compartment.



Do not drive the car with the charging flap **9** open condition. Once the V2L connector is unplugged from the vehicle, make sure that the cap is put and the charging flap **9** is properly closed.

### Settings



You can set the threshold's value for the minimum traction battery charge level from the multimedia screen **13**.

For more information, refer to the multimedia manual.

### Operating faults

In case of operating faults, the indicator light **2** on the V2L connector goes out and the V2L power supply (discharge) automatically turns off. A message is displayed on the instrument panel to inform you.

**In case of V2L function internal failure**, message « V2L discharge impossible V2L to check » is displayed on the instrument panel: unplug the device and disconnect the V2L connector. please contact an approved dealer.

**In case of V2L function failure coming from the device connected to V2L connector AC outlet**, message « V2L discharge impossible - appliance connected fault » is displayed on the instrument panel:

- unplug the device and the V2L connector;
- check that the device and the V2L connector are not damaged and that the power plug is not broken or corroded;
- make sure that the electrical device does not exceed the maximum power capacity that the vehicle can supply.

If a fault occurs again, please contact an approved dealer.

# KEY, REMOTE CONTROL

## General information

### Radio frequency remote control A

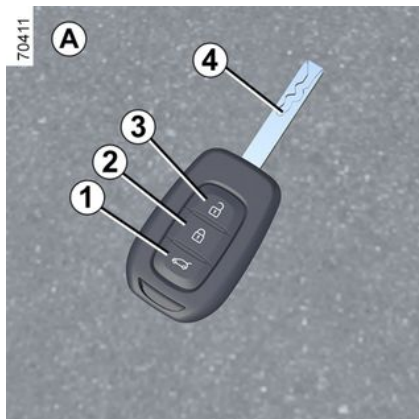

1. Lock/ Unlock (Tailgate / Luggage compartment)
2. Locks all the opening elements (all doors/tail gate)
3. Unlocks all opening elements and the charging cord (when plugged to the vehicle → 26)
4. Driver's door lock/unlock and ignition/start key insert.



### Replacement and additional keys or remote controls.

You must only contact an approved dealer :

- If you need to replace a key it will be necessary to take the vehicle and all of its keys to an approved dealer in order to initialise the system;
- Depending on the vehicle, you have the option of using up to four remote controls.

#### Remote control unit failure

Make sure that the correct battery type is being used, and that the battery is in good condition and inserted correctly. These batteries have a service life of approximately two years.

How to change the battery → 49

### Spare Key B



Spare key provided for ignition start.

### Radio frequency remote control operating range

This varies according to the surroundings : take care not to lock or unlock the doors by inadvertently pressing the buttons on the remote control.

**Note :** If a door or the luggage compartment lid is open or not closed properly, the doors and luggage compartment lid lock/unlock quickly.

#### Interference

Interference by factors in the immediate vicinity (external installations or the use of equipment operating on the

## KEY, REMOTE CONTROL

same frequency as the remote control) may affect the operation of the remote control.



### Advice

Avoid leaving the remote control in hot, cold or humid areas.



The key must not be used for any function other than those described in the handbook (removing the cap from a bottle, etc.).



### Driver's responsibility when parking or stopping the vehicle

Never leave an animal, child or adult who is not self-sufficient alone in your vehicle, even for a short time.

They may pose a risk to themselves or to others by starting the engine, activating equipment such as the electric windows or locking the doors, for example.

Also, in hot and/or sunny weather, please remember that the temperature inside the passenger compartment increases very quickly.

**RISK OF DEATH OR SERIOUS INJURY**

### Use

Remote controls are used to lock or unlock the doors and boot.

They are powered by a battery which can be replaced → 49

## Locking the doors

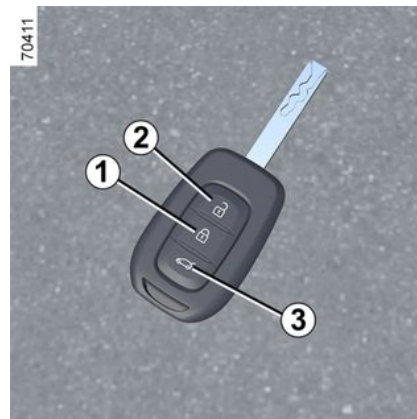

Pressing button **1** locks the doors and tailgate

Pressing button **3** locks the luggage compartment

The side indicator lights and hazard warning lights confirm the **locking** by **flashing twice**

## KEY, REMOTE CONTROL

 depending on the vehicle, if a door or the luggage compartment is open or not properly shut, they will lock and unlock in quick succession without any flashing of the hazard warning lights and side indicator lights.

### Unlocking the doors

Pressing button **2** unlocks the opening elements (all doors/ tailgate) and the charging cord (when plugged to the vehicle).

Pressing button **3** locks the luggage compartment.

The **unlocking** is confirmed by **one flash** of the hazard warning lights and the side indicator lights.

 With the engine running and the ignition on ➔ **127** the remote control buttons are inactive.

### Special feature

After manually locking the rear hinged door, press the **3** button twice to unlock it ➔ **51**.



### Driver's responsibility when parking or stopping the vehicle

Never leave an animal, child or adult who is not self-sufficient alone in your vehicle, even for a short time.

They may pose a risk to themselves or to others by starting the engine, activating equipment such as the electric windows or locking the doors, for example.

Also, in hot and/or sunny weather, please remember that the temperature inside the passenger compartment increases very quickly.

**RISK OF DEATH OR SERIOUS INJURY**

## Radio frequency remote control: battery

### Replacing the battery

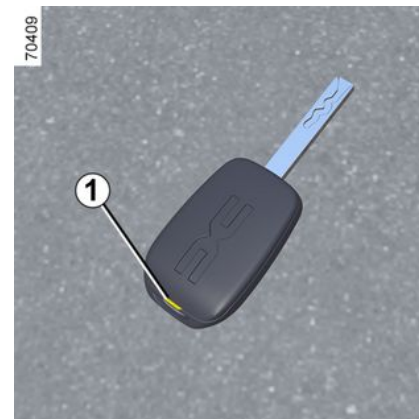

Open the case at slot **1** using a flat blade screwdriver or similar, and replace the battery **2**, observing the type and polarity shown on the back of the cover.



When they need to be replaced, be sure to use the same or equivalent type of battery (consult an approved Dealer).

2

## KEY, REMOTE CONTROL

**i** The batteries are available from approved dealers, and their service life approximately two years. Check that there is no dye on the battery : risk of an incorrect electrical contact.

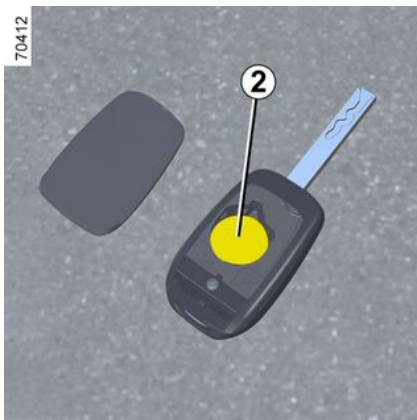

Ensure that the cover is correctly clipped on and the screw tightened.

**Note :** It is not advisable to touch the electronic circuit in the key cover when replacing the battery.

### Operating faults

If the battery is too weak to ensure correct operation, you can still start and lock/unlock the vehicle. ➔ 52

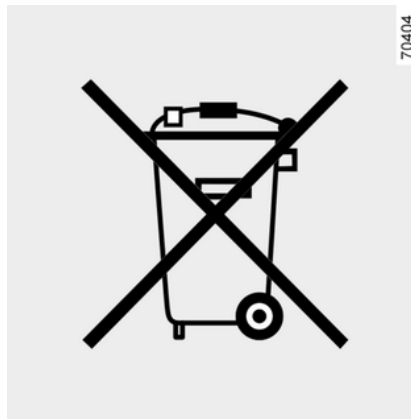

**i** Do not throw away your used batteries as rubbish. Take them to an approved dealer or consult your local authority for information on appropriate recycling facilities.



When replacing:

- make sure that the batteries are correctly inserted.

### Risk of explosion.

- if the flap does not close correctly, do not use and keep out of reach of children.



**Precautions relating to batteries:**

- keep (new or used) batteries out of reach of children;
- do not swallow batteries.

**Risk of chemical burns which may prove fatal.**

- if ingested or inserted into any part of the body, consult a doctor as soon as possible.

# DOORS AND OPENING ELEMENTS

## Opening and closing the doors

### Opening the doors from the outside



With the doors unlocked → 52, place your hand on the handle **1** and pull towards you.

### Opening from the inside



Pull handle **2**.

### Child safety

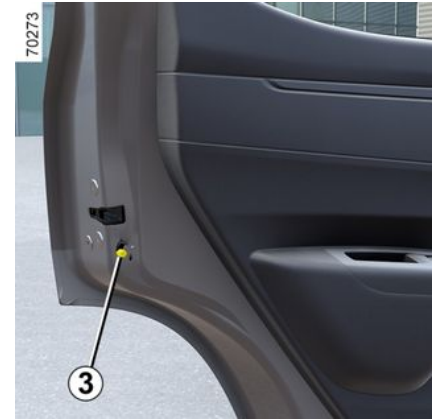

The child safety lock prevents the rear doors from being opened from the inside. Move lever **3** on each rear door

toward  and check from the inside that the doors are securely locked.

### Lights-on reminder buzzer

If you have left the lights on after switching off the ignition, a warning buzzer will sound when a front door is opened (to prevent the battery from discharging, etc.).

### Door/tailgate open buzzer

This alarm is fitted to the driver's side door or on all opening elements.

## DOORS AND OPENING ELEMENTS

With the vehicle at a standstill, a warning light  will come on if a door or the boot is open or not properly closed.

While driving, as soon as the vehicle reaches 12 mph (20 km/h) approxi-

mately, warning light  is accompanied by a beep.

### Special note

Depending on the vehicle, accessories (e.g. radio) stop working either when the engine is switched off or when the driver's door is open or when the doors are locked.



As a safety precaution, the doors should only be opened or closed when the vehicle is stationary.



### Driver's responsibility when parking or stopping the vehicle

Never leave an animal, child or adult who is not self-sufficient alone in your vehicle, even for a short time.

They may pose a risk to themselves or to others by starting the engine, activating equipment such as the electric windows or locking the doors, for example.

Also, in hot and/or sunny weather, please remember that the temperature inside the passenger compartment increases very quickly.

**RISK OF DEATH OR SERIOUS INJURY**

## Locking, unlocking the opening elements and doors

### Manual control



### From the outside

Insert the key into the lock **1** and lock or unlock the front door.

## DOORS AND OPENING ELEMENTS



**From the inside  
(Front door)**

Pull handle **2** to unlock the door.



Never leave your vehicle  
with the key inside.



**From the inside  
(Rear door)**

Push in button **3** to lock and lift button **3** to unlock. It is impossible to open the door if **3** is pushed in.

## Interior locking/unlocking door control



By pressing **4**, It simultaneously locks or unlocks all the doors/tail gate and the charging gets stopped (when charging).

If a door or the tailgate is open or not closed properly, the doors and tailgate lock/unlock quickly.

If you need to transport objects with the boot open, the other opening elements can still be locked : **with the engine stopped**, press switch **4** for more than five seconds to lock the other opening elements.

2

## DOORS AND OPENING ELEMENTS

### Locking the opening elements without the radio frequency remote control

For example, in the event of a discharged battery or the radio frequency remote control temporarily not working or using the spare key.

**Press and release the switch 4 to release the charging cable when remote control is not working**

**With engine switched off and any door open, press and hold the switch 4 for more than five seconds.** When the door is closed, all the doors will be locked. Unlocking the vehicle from outside is only possible with the key.



#### Driver's responsibility

If you decide to keep the doors locked when you are driving, remember that it may be more difficult for those assisting you to gain access to the passenger compartment in the event of an emergency.



#### Driver's responsibility when parking or stopping the vehicle

Never leave an animal, child or adult who is not self-sufficient alone in your vehicle, even for a short time.

They may pose a risk to themselves or to others by starting the engine, activating equipment such as the electric windows or locking the doors, for example.

Also, in hot and/or sunny weather, please remember that the temperature inside the passenger compartment increases very quickly.

**RISK OF DEATH OR SERIOUS INJURY**

### Automatic locking when driving

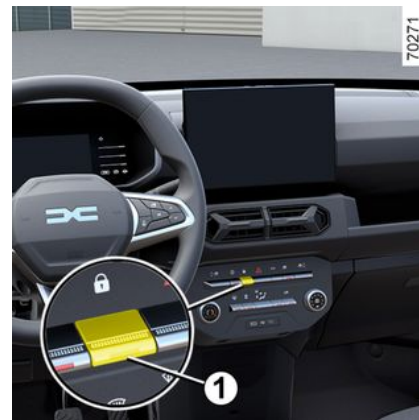

**You must first decide if you want to activate this function.**

#### To activate

Depending on the vehicle, **with the engine running**, press switch **1** for approximately 5 seconds until you hear a beep. The indicator light built into the switch comes on when the doors are locked.

#### To deactivate

**With the ignition on**, press switch **1** for approximately 5 seconds until you hear a beep.

# DOORS AND OPENING ELEMENTS

## Operating principle

When the engine is started, the system automatically locks the doors when the vehicle reaches a speed of approximately 4 mph (7 km/h).

## Operating faults

If you notice that the system is not operating correctly (automatic locking does not take place), first check that all the doors have been properly closed. If they are correctly locked and the fault is still present, contact an authorised dealer.

Also make sure that locking has not been inadvertently deactivated. If this is the case, reactivate it.



### Driver's responsibility

If you decide to keep the doors locked when you are driving, remember that it may be more difficult for those assisting you to gain access to the passenger compartment in the event of an emergency.



### Driver's responsibility when parking or stopping the vehicle

Never leave an animal, child or adult who is not self-sufficient alone in your vehicle, even for a short time.

They may pose a risk to themselves or to others by starting the engine, activating equipment such as the electric windows or locking the doors, for example.

Also, in hot and/or sunny weather, please remember that the temperature inside the passenger compartment increases very quickly.

**RISK OF DEATH OR SERIOUS INJURY**

## Boot

### To open



### From the outside

By pressing the unlock button in radio frequency remote control, the doors and the tail gate gets unlocked → 47

Press truck switch **1** to open the tail gate from outside in vehicle unlock condition.

## DOORS AND OPENING ELEMENTS

2



The attaching of any carrying device (bike rack, luggage box etc.) resting on the luggage compartment lid is prohibited. To install a carrying device on your vehicle, contact an approved Dealer.

### To close

Lower the luggage compartment door by pressing down on the tailgate from the outside.



Never use the struts to close the luggage compartment door.

### Electric central locking

The tailgate is locked and unlocked at the same time as the doors.

Once you have lowered the tailgate to shoulder height, and finish closing the tailgate by pressing down on the tailgate from the outside.

## ENGINE IMMOBILISER

Engine Immobiliser prevents the vehicle being driven by anyone not in possession of the vehicle's coded ignition key.

### Operating principle

The vehicle is automatically protected a few seconds after the ignition is switched off.

If the vehicle does not recognise the coded ignition key or wrong key is used, the engine cannot be started.

### System operation



When the ignition is switched on, the vehicle has recognised the code. You can then start the engine.

### Vehicle protection

The vehicle will only be protected after the ignition has been switched off.

### Operating faults

If there is any fault observed in the function which is accompanied by

warning lights  and , it is essential to contact an approved dealer as only they are qualified to repair the engine immobiliser.

If the coded ignition key is faulty, use the spare key (supplied with the vehicle).



Warning light  requires you to stop immediately, for your own safety, as soon as traffic conditions allow. Switch off the engine and do not restart it. Contact an approved Dealer.



Any unauthorised work carried out on the engine immobiliser (computers, wiring, etc.) could be dangerous. Work must be carried out by qualified personnel.



**Driver's responsibility when parking or stopping the vehicle**

Never leave an animal, child or adult who is not self-sufficient alone on your vehicle, even for a short time. They may pose a risk to themselves or to others by starting the engine, activating equipment such as the electric windows or by locking the doors. Also, in hot and/or sunny weather, please remember that the temperature inside the passenger compartment increases very quickly. **RISK OF DEATH OR SERIOUS INJURY.**

## FRONT SEATS

### To tilt the seatback



Lift knob **1** upward to unlock recliner mechanism. Tilt the seat back to desired position and release knob. Ensure seat back is locked properly after release.

### Move forward or backward

Lift the handle **2** to release and move the seat forward or backward. Release the handle **2** in desired position of seat and ensure that the seat is fully locked into place.



For safety reasons, carry out any adjustments when the vehicle is not being driven.

Nothing should be placed on the floor (area in front of driver) as such objects may slide under the pedal during braking manoeuvres, thus obstructing its use.



We would advise you not to recline the seatbacks too far to ensure that the effectiveness of the seat belts is not reduced.

# REAR SEATS

## Rear headrests

### To raise headrests A



Pull the headrest upwards to the desired height.

### To lower headrests A

Press button **1** and guide the headrest using the notches marked on the rods, down to the desired height.

### To remove headrests A

Press button **1** and lift the headrest to release it.

### To reposition headrests A

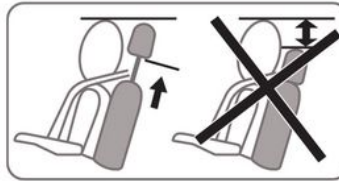

Insert the rods into the rear seat sleeves with the notches in position **1** and lower the headrest to the desired position. Check that it is locked in place.



The headrest is a safety component ; check that it is fitted and in the correct position. The top of the headrest should be as close as possible to the top of the head.

### Rear bench seat: functions

#### To fold the backrest

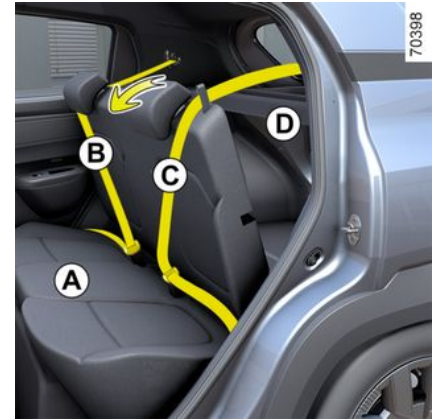

Before folding down a seatback :

- Lower the headrest fully.
- During folding, left and right seat belts must be positioned and seat belts should be buckled to the cushion buckles in order to protect seat belt jamming between seat back and latch.
- Hold straps **B** and **C** and pull them together to unlatch the seatback.
- Hold the seatback and pull down towards **A**,

#### Refitting the seatback

- Lower the headrest fully.
- During unfolding left and right seat belts must be positioned and seat belts

## REAR SEATS

should be buckled to the cushion buckles in order to protect seat belt jamming between seat back and latch.

– Push the seatback toward **D** and ensure both latches locked properly



Allow the seatback turn on its axis naturally without forcing it, guiding it as it lowers onto the seat base.



When moving the rear bench seat, ensure that nothing obstructs the anchorage points (part of the body, a pet, gravel, cloth, toys, etc.).



Check that the rear seat belts are positioned and operating correctly each time the rear bench seat is moved.



For safety reasons, carry out any adjustments when the vehicle is not being driven.



**When refitting the seatback**, make sure it is correctly locked in place.

**If seat covers are fitted**,

make sure these do not prevent the seatback latch from locking in.

Make sure that the seat belts are positioned correctly.

Reposition the headrests.

# SEAT BELTS

## Seat belts

Always wear your seat belt when travelling in your vehicle. You must also comply with the legislation of the particular country you are in.

**Before starting, first adjust your driving position, then ask all occupants to adjust their seat belts to ensure optimum protection.**



Incorrectly adjusted or twisted seat belts may cause injuries in the event of an accident.

Use one seat belt per person, whether child or adult.

Even pregnant women should wear a seat belt. In this case, ensure that the lap belt is not exerting too much pressure on the abdomen, but do not allow any slack.

Depending on the vehicle, an object on the passenger seat may, in some cases activate the warning light

**Adjusting your driving position**

**Adjusting your driving position**

- **Sit well back in your seat** (having removed your coat or jacket etc.). This is essential to ensure your back is positioned correctly ;
- **adjust the distance between the seat and the pedals.** Your seat should be as far back as possible while still allowing you to fully depress the clutch pedals. The seatback should be adjusted so that your arms are slightly bent when you hold the steering wheel ;
- **adjust the position of the steering wheel.**

## Adjusting the seat belts



For correct adjustment and positioning of the seat belts at all seats:

- adjust the seats (seat position and seatback angle, if available);
- sit with your back firmly against the seatback;
- move the chest strap **1** as close as possible to the base of the neck without it actually resting against it (if necessary, adjust the height of the seat belt if available) and make sure that the chest strap **1** is in contact with the shoulder;
- position the lap belt **2** so that it lies flat on the thighs and against the pelvis.

The belt should be worn so that it is as close as possible to your body, i.e. : avoid wearing heavy clothing or keeping bulky objects under the belts, etc.

## Locking

Unwind the belt **slowly and smoothly** and ensure that the buckle locks **3** into the catch **5** (check that it is locked by pulling on the buckle **3**). If the belt jams, allow it to return slightly before attempting to unwind it again.

If your seat belt is completely jammed, pull slowly, but firmly, so that just over 3 cm unwinds. Allow it to return slightly before attempting to unwind it again.

If there is still a problem, contact an approved dealer.

## SEAT BELTS

### Unlocking

Press the button **4** on catch **5** and the seat belt will be rewound by the inertia reel. Guide the tongue plate to rewind smoothly.



### Seat belt reminder warning lights

This warning light appears on the instrument panel **7** when the ignition is switched on and if the driver's and/or front passenger (if the seat is occupied) and/or rear passenger seat belt(s) is not fastened.

#### Front seat belt reminder warning

With the doors closed, and the graphic **7** appears on when the vehicle ignition is switched on. This informs the driver of the fastening status of each of the front seat belts every time:

- the doors are opened during driving (vehicle speed above zero);
- a front seat belt is fastened/unfastened.

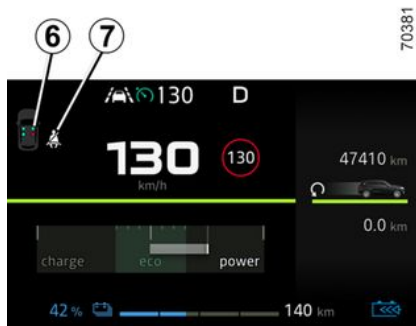

#### Understanding the graphic **6**:

- symbol in green: seat belt fastened;
- symbol in red: the seat is occupied and the seat belt is not fastened;
- symbol in grey: seat not occupied.

#### Understanding the graphic **7**:

- symbol in white: seat belt fastened;
- symbol in red: seat belt is not fastened.

When the vehicle speed is less than approximately 12 mph (20 km/h), the graphic **7** appears on the instrument panel if a seat is occupied and the seat belt is not fastened. It is accompanied by the graphic **6** which appears for approximately 60 seconds each time one of the seat belts is fastened or unfastened.

When the vehicle speed reaches or exceeds 12 mph (20 km/h), if one of the seat belts is or becomes unfastened during the journey:

- the graphic **7** flashes on the instrument panel;  
and continuously ON,
- a beep sound for approximately 120 seconds;  
and,
- the graphic **6** is displayed for approximately 180 seconds and the symbol for the seat concerned changes to red.

Always make sure that the front passengers are properly fastened and that the number of fastened seat belts indicated corresponds to the number of front seats occupied.

**Note:** an object placed on the front passenger seat may activate the warning light in some cases.

#### Rear seat belt reminder

With the doors closed, the graphic **6** is displayed on the instrument panel for approximately 60 seconds and the graphic **7** appears on when the when the vehicle ignition is switched on. This informs the driver of the fastening status of each of the rear seat belts every time:

## SEAT BELTS

- the doors are opened during driving (vehicle speed above zero);
- a rear seat belt is fastened/unfastened.

### Understanding the graphic 6:

- symbol in green: seat belt fastened;
- symbol in red: seat belt is not fastened.

### Understanding the graphic 7:

- symbol in white: seat belt fastened;
- symbol in red: seat belt is not fastened.

When the vehicle speed is less than approximately 12 mph (20 km/h), the graphic 7 which appears on each time one of the rear seat belts is fastened or unfastened. It is accompanied by the graphic 6 which appears for approximately 60 seconds.

When the vehicle speed reaches or exceeds 12 mph (20 km/h), if one of the rear seat belts is or becomes unfastened during the journey:

- the graphic 7 flashes on the instrument panel;  
and continuously ON
- a beep sound for approximately 30 seconds;  
and
- the graphic 6 is displayed for approximately 60 seconds and the

symbol for the seat concerned appears in red.

Always make sure that the passengers are properly fastened in and that the number of seat belts indicated as fastened corresponds to the number of seats occupied.



Make sure that the rear bench seat is locked in position correctly so that the rear seat belts will operate correctly → 59.

### Adjusting the height of the front seat belts



Move button 8 to select the position you require so that chest strap 1 is worn as described above.

Make sure that the seat belt is locked in position correctly after you have adjusted it.

## Rear seat belts

### Rear side seat belts

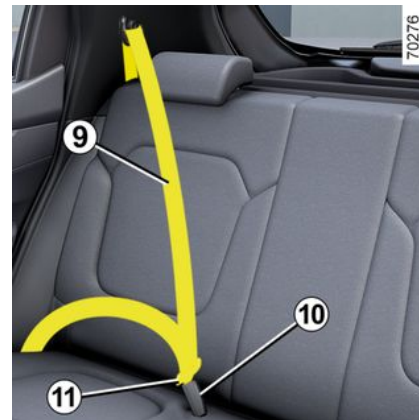

Slowly unwind the belt 9 and click the buckle 11 into the catch 10.

## SEAT BELTS

2



Check that the rear seat belts are positioned and operating correctly each time the rear bench seat is moved.

# SEAT BELTS

## Warnings

The following information applies to the vehicle's front and rear seat belts.



- No modification must be made to the originally-fitted restraint system components (seat belts, seats and their mountings). For special operations (e.g. fitting child seats) please contact an approved dealer.
- Do not use devices which give any slack in the belts (e.g. clothes pegs, clips, etc.), as a seat belt which is worn too loosely risks causing injury in the event of an accident.
- Never wear the shoulder strap under your arm or behind your back.
- Never use the same belt for more than one person and never hold a baby or child on your lap with your seat belt around them.
- The belt should never be twisted.
- Following an accident, have the seat belts checked and replaced if necessary. Always replace your seat belts as soon as they show any signs of wear.
- When positioning the rear bench seat, make sure that the seat belts and buckles are correctly positioned so that they can be used properly.
- Make sure that the seat belt buckle is inserted into the appropriate catch.
- Ensure that no objects are placed in the area around the seat belt catch as they could prevent it from being properly secured.
- Make sure the seat belt catch is properly positioned (it should not be hidden away, crushed or flattened by people or objects).

## ADDITIONAL SAFETY DEVICES

2

### Methods of restraint in addition to the front seat belts

They are comprised of :

- seat belt inertia reel pretensioners ;
- chest-level load limiters ;
- airbags - Driver and front passenger.

These systems are designed to act independently or together when the vehicle is subjected to a frontal impact.

Depending on the severity of the impact, the system can trigger :

- seat belt locking ;
- the seat belt inertia reel pretensioner (which engages to correct seat belt slack) ;
- the front airbag.

### Pretensioners



The pretensioners hold the seat belt against the body, holding the occupant more securely against the seat, thus increasing the seat belt's efficiency.

With the ignition on, following a significant frontal impact and depending on the severity of the impact, the system may trigger the seat belt inertia reel pretensioner **1**, which instantly retracts the seat belt.



- Have the entire restraint system checked following an accident.
- No operation whatsoever is permitted on any part of the system (pretensioners, airbags, computers, wiring) and the system components must not be reused on any other vehicle, even if identical.
- Only qualified personnel from our Network may work on the airbags; otherwise the system may trigger accidentally and cause injury.
- The electric trigger system may only be tested by a specially trained technician using special equipment.
- When the vehicle is scrapped, contact an approved dealer for disposal of the pretensioner and airbags gas generators.

### Load limiter

Above a certain severity of impact, this mechanism is used to limit the force of the belt against the body so that it is at an acceptable level.

## ADDITIONAL SAFETY DEVICES

### Airbags for driver and front passenger

Fitted to the driver and passenger side.

The presence of this equipment is indicated by the word « airbag » on the steering wheel and dashboard (airbag zone **A**) and, depending on the vehicle, a symbol on the lower section of the windscreen.

Each airbag system consists of :

- an airbag and gas generator fitted on the steering wheel for the driver and in the dashboard for the front passenger ;
- an electronic unit for system monitoring which controls the gas generator electrical trigger system ;
- a single  warning light on the instrument panel.



The airbag system uses pyrotechnic principles. This explains why, when the airbag inflates, it will generate heat, produce smoke (this does not mean that a fire is about to start) and make a banging noise. In a situation where an airbag is required, it will inflate immediately and this may cause some minor, superficial grazing to the skin or other problems.



### Operation

This system is only operational when the ignition is switched on.

In a severe **frontal** impact, the airbags inflate rapidly, cushioning the impact of the driver's head and chest against the steering wheel and of the front passenger against the dashboard. The Airbags then deflate immediately so that the passengers are not in any way hindered from leaving the vehicle.

### Operating faults



This warning light will light up on the instrument panel when the ignition is switched on and then go out after a few seconds.

## ADDITIONAL SAFETY DEVICES

If it does not light up when the ignition is switched on, or comes on when the engine is running, there is a fault in the system.

Contact your approved Dealer as soon as possible. Your protection will be reduced until this fault is rectified.

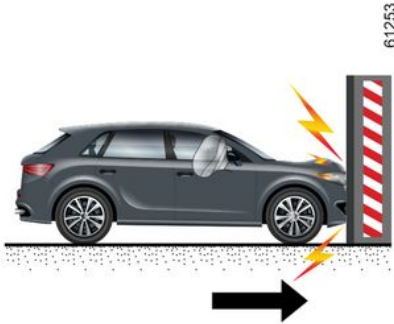

The following conditions will trigger the pretensioners or airbags.

In a frontal impact against a rigid (non-deformable) surface at an impact speed equal to or greater than 16 mph (25 km/h).

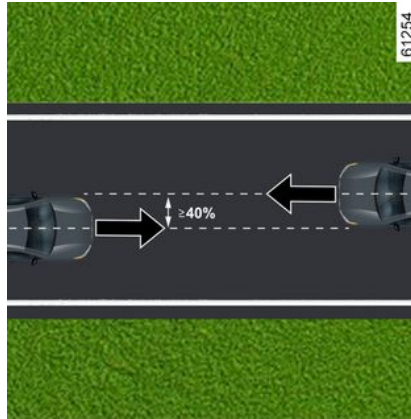

In a frontal impact with another vehicle of an equivalent or higher category, with an impact area equal to or greater than 40 %, where the speed of both vehicles is equal or greater than 25 mph (40 km/h).

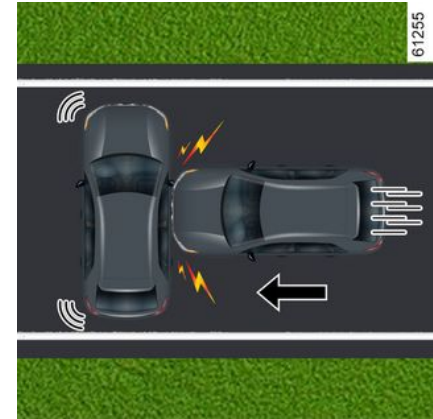

In a side impact with another vehicle of an equivalent or higher category, at an impact speed equal to or greater than 31 mph (50 km/h).

## ADDITIONAL SAFETY DEVICES

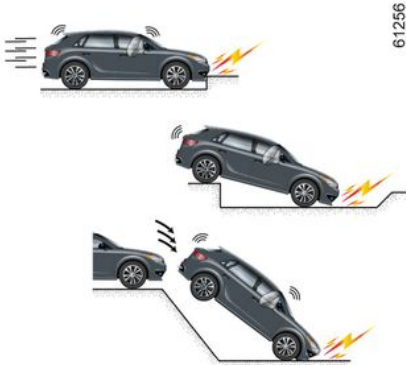

**In the following examples, the pretensioners or the airbags could operate:**

- impacts to the underside of the vehicle from kerbs, for example;
- potholes;
- a fall or a hard landing;
- stones;
- ....



**In the following examples, the pretensioners or airbags might not operate:**

- rear impact, however severe;
- if the vehicle overturns;



- side impact, affecting the front of the vehicle;
- frontal impact, under the tail of a lorry;
- frontal impact against an obstacle with a sharp angle;
- ....

## ADDITIONAL SAFETY DEVICES

### Warnings

**All of the warnings below are given so that the airbag is not obstructed in any way when it is inflated and also to prevent the risk of serious injuries caused by items which may be dislodged when the airbag inflates.**



#### **Warnings concerning the driver's airbag**

- Do not modify the steering wheel or the steering wheel boss.
- Do not cover the steering wheel boss under any circumstances.
- Do not attach any objects (badge, logo, clock, telephone holder, etc.) to the steering wheel boss.
- The steering wheel must not be removed (except by qualified personnel from our Network).
- Do not sit too close to the steering wheel : adopt a driving position whereby your arms are slightly folded. This will allow sufficient space for the airbag to deploy correctly and be fully effective. ➔ 61

#### **Warnings concerning the passenger airbag**

- Do not attach or glue any objects (badge, logo, clock, telephone holder, etc.) to the dashboard on or near the airbag.
- Do not place anything between the dashboard and the passenger (pet, umbrella, walking stick, parcels, etc.).
- The passenger must not put his or her feet on the dashboard or seat as there is a risk that serious injuries may occur. In general, parts of the body should be kept away from the dashboard (knees, hands, head, etc.).
- The devices in addition to the front passenger seat belt should be reactivated as soon as a child seat is removed, to ensure the protection of the passenger in the event of an impact.

**A REAR-FACING CHILD SEAT MUST NOT BE FITTED TO THE FRONT PASSENGER SEAT UNLESS RESTRAINT SYSTEMS IN ADDITION TO THE FRONT PASSENGER SEATBELT ARE DEACTIVATED ➔ 92**

## ADDITIONAL SAFETY DEVICES

### Methods of restraint in addition to the rear seat belts

Depending on the vehicle, they will consist of :

- **side seat belt inertia pretensioners ;**
- **chest force limiters ;**

These systems are designed to act independently or together when the vehicle is subjected to a frontal impact.

Depending on the severity of the impact, the system can trigger :

- seat belt locking ;
- the seat belt inertia reel pretensioner (which engages to correct seat belt slack).

### Force limiter

Above a certain severity of impact, this mechanism is used to limit the force of the belt against the body so that it is at an acceptable level.

### Side seat belt pretensioners

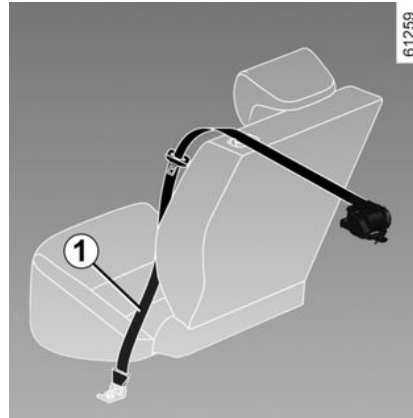

The pretensioners hold the seat belt against the body, holding the occupant more securely against the seat, thus increasing the seat belt's efficiency.

With the ignition on, following a significant frontal impact and depending on the severity of the impact, the system may trigger the seat belt inertia reel pretensioner **1**, which instantly retracts the seat belt.



- Have the entire restraint system checked following an accident.
- No operation whatsoever is permitted on any part of the system (pretensioners, air bags, computers, wiring) and the system components must not be reused on any other vehicle, even if identical.
- Only qualified personnel from our Network may work on the airbags; otherwise the system may trigger accidentally and cause injury.
- The electric trigger system may only be tested by a specially trained technician using special equipment.
- When the vehicle is scrapped, contact an approved Dealer for disposal of the pretensioner and airbag gas generators.

### Side protection devices

#### Side airbags

This airbag is fitted to the front seats, activated at the sides of the seats

## ADDITIONAL SAFETY DEVICES

(door side) to protect the occupants in the event of a severe side impact.

### **Curtain airbags**

This is an airbag fitted (depending on the vehicle) along the upper sides of the vehicle – they inflate along the front and rear door side windows to protect the passengers in the event of a severe side impact.



Depending on the vehicle, a marking on the wind-screen informs you of the presence of additional means of restraint (airbags, pretensioners etc.) in the passenger compartment.

# ADDITIONAL SAFETY DEVICES

## Warnings



### Warning relating to the side airbag

- **Fitting seat covers** : seats equipped with an airbag require covers specifically designed for your vehicle. Contact an approved dealer to find out if these covers are available. The use of any covers other than those designed for your vehicle (including those designed for another vehicle) may affect the operation of the airbags and reduce your protection.
- Do not place any accessories, objects or even pets between the seatback, the door and the internal fittings. Do not cover the seatback with any items such as clothes or accessories. This may prevent the airbag from operating correctly or cause injury when the airbag is deployed.
- No work or modification whatsoever may be carried out on the seat or internal fittings, except by qualified personnel from an approved dealer.
- The space between the seatback of the rear bench seat and the trim is the area of airbag operation : no objects must be placed here.

## ADDITIONAL SAFETY DEVICES

### Additional methods of restraint

2

All of the warnings below are given so that the airbag is not obstructed in any way when it is inflated and also to prevent the risk of serious injuries caused by items which may be dislodged when it inflates.



The airbag is designed to complement the action of the seat belt. Both the airbags and seat belts are integral parts of the same protection system. It is therefore essential to wear seat belts at all times. If seat belts are not worn, the occupants are exposed to the risk of serious injury in the event of an accident. It may also increase the risk of minor superficial injuries occurring when the airbag is deployed, although such minor injuries are always possible with airbags.

If the vehicle should overturn or in the event of a rear impact, however severe, the pretensioners and airbags are not always triggered. Impacts to the underside of the vehicle, e.g. from pavements, potholes or stones, can all trigger these systems.

- Work and modifications on the complete airbag system (airbags, pretensioners, ECU, wiring harness, etc.), **are strictly prohibited** (except by qualified Network personnel).
- To ensure that the system is in good working order and to avoid accidental triggering of the system which may cause injury, only qualified Network personnel may work on the airbag system.
- As a safety precaution, have the airbag system checked if your vehicle has been involved in an accident, or is stolen or broken into.
- When selling or lending the vehicle, inform the user of these points and hand over this handbook with the vehicle.
- When scrapping your vehicle, contact your approved dealer for disposal of the gas generator(s).

# CHILD SAFETY

## General information

### Carrying children

Please ensure that you comply with the legislation of your country.

Children, and adults, must be correctly seated and strapped in for all journeys. The children being carried in your vehicle are your responsibility.

A child is not a miniature adult. Children are at risk of specific injuries as their muscles and bones have not yet finished growing. The seat belt alone would not provide suitable protection. Use an approved child seat and ensure you use it correctly.



To prevent the doors being opened, use the « Child lock » feature  
→ 51



A collision at 30 mph (50 km/h) is the same as falling a distance of 10 metres. Transporting a child without a restraint is the equivalent of allowing him or her to play on a fourth floor balcony without railings. Never travel with a child held in your arms. In the event of an accident, you will not be able to keep hold of the child, even if you yourself are wearing a seat belt. If your vehicle has been involved in a road accident, replace the child seat and have the seat belts and ISOFIX anchorage points checked



### **Driver's responsibility when parking or stopping the vehicle**

Never leave an animal, child or adult who is not self-sufficient alone on your vehicle, even for a short time. They may pose a risk to themselves or to others by starting the engine, activating equipment such as the electric windows or by locking the doors. Also, in hot and/or sunny weather, please remember that the temperature inside the passenger compartment increases very quickly.  
**RISK OF DEATH OR SERIOUS INJURY.**

### Using a child seat

The level of protection offered by the child seat depends on its ability to restrain your child and on its installation. Incorrect installation compromises the protection it offers the child in the event of harsh braking or an impact.

Before purchasing a child seat, check that it complies with the regulations for the country you are in and that it can be fitted in your vehicle. Consult an ap-

## CHILD SAFETY

proved dealer to find out which seats are recommended for your vehicle.

The regulation on transporting children are specific to each country. The use of child seat during transport depends on the age and/or height and/ or weight of the child. For children who no longer need to be transported in a child seat, make sure that the seat belt is correctly adjusted and fastened.

In all cases, comply with the local legislation of the country where you located.

Before fitting a child seat, read the manual and respect its instructions. If you experience any difficulties during installation, contact the manufacturer of the equipment. Keep the instructions with the seat.

It is not necessary to carry any child restraint system for children over the age of 7.5. They can travel in the rear seat using the safety belt in the vehicle.

Always consult the regulations in force in your country.

Before fitting a child seat, read the manual and respect its instructions. If you experience any difficulties during installation, contact the manufacturer of the equipment. Keep the instructions with the seat.



Set a good example by always fastening your seat belt and teaching your child :

- to strap themselves in correctly.
- to always get in and out of the car at the kerb, away from busy traffic.

Do not use a second-hand child seat or one without an instruction manual.

Check that there are no objects in the vicinity of the child seat which could impede its operation.



Never leave a child unattended in the vehicle.

Check that your child is always strapped in and that the belt or safety harness used is correctly set and adjusted. Avoid wearing bulky clothing which could cause the belts to slacken → 61.

Never let your child put their head or arms out of the window. Check that the child is in the correct position for the entire journey, especially if asleep.

# CHILD SAFETY

## Choosing a child seat



### Rear-facing child seats

A baby's head is, proportionally, heavier than that of an adult and its neck is very fragile. Transport the child in this position for as long as possible (until the age of 2 at the very least). It supports both the head and the neck.

Choose a bucket type seat for best side protection and change it as soon as the child's head is higher than the shell.



### Forward-facing child seats

The child's head and abdomen need to be protected as a priority. A forward-facing child seat which is firmly attached to the vehicle will reduce the risk of impact to the head. Ensure your child travels in a forward-facing seat with a harness for as long as their size permits.

Choose a bucket type seat for optimum side protection.



### Booster cushions

From 15 kg or 4 years, the child can travel using a booster seat, which will enable the seat belt to be adapted to suit his/her size and shape. The booster seat cushion must be fitted with guides to position the seat belt on the child's thighs rather than the stomach. It is recommended that you use a seat-back fitted with a belt strap guide which can be adjusted in terms of height to position the seat belt in the centre of the shoulder. It must never rest on the neck or on the arm.

Choose a bucket type seat for optimum side protection.

## CHILD SAFETY

### Choosing a child seat mounting

There are two ways of attaching child seats : via the seat belt or using the ISOFIX system.

#### Attachment via the seat belt

The seat belt must be adjusted in order to ensure it works in the event of sudden braking or impact

Ensure that the strap paths indicated by the child seat manufacturer are respected

Always check that the seat belt is correctly fastened by pulling it up, then pulling it out fully whilst pressing on the child seat.

Check that the seat is correctly held by moving it from side to side and back to front : the seat should remain firmly fixed.

Check that the child seat has not been installed at an angle and that it is not resting against a window.



Do not use the child seat if it may unfasten the seat belt restraining it : the base of the seat must not rest on the buckle and/or catch of the seat belt.



The seat belt must never be twisted or the tension relieved. Never pass the shoulder strap under the arm or behind the back. Check that the seat belt has not been damaged by sharp edges. If the seat belt does not operate normally, it will not protect the child. consult an approved dealer. Do not use this seat until the seat belt has been repaired.

#### Attachment using the ISOFIX system

Authorised ISOFIX child seats are approved in accordance with regulation ECE-R44 in one of the three following scenarios:

- universal ISOFIX 3-point forward-facing seat ;
- semi-universal ISOFIX 2-point seat ;
- specific.
- i-Size which has either :
  - strap which attaches to the third ring of the seat concerned ;
  - or a strut that rests on the vehicle floor, compatible with the approved seat i-Size, the role of which is to prevent the child seat from moving in the event of a collision.



#### Attachment with the ISOFIX system (continued)

The rings **1** are located between the seatback and the seat base of the seat

and are identified by a  symbol.

The third ring **3** is used to attach the upper strap on some child seats.



No modifications may be made to the component parts of the restraint system (seat belts, ISOFIX,, seats and their mountings) originally fitted.

## CHILD SAFETY



Pass the belt **2** between the seatback and the luggage compartment cover. To do so, first remove the luggage compartment cover. Attach the belt hook to one of the rings **3**, indicated

by the symbol .

Pull the belt **2** so that the back of the child seat comes into contact with the vehicle seatback.



The child seat strap **must** be attached to the corresponding ring. Do not use any other mounting point.



Before using an ISOFIX child seat that you purchased for another vehicle, check that its installation is authorised. Consult the list of vehicles which can be fitted with the seat from the equipment manufacturer.



Check that the seatback of the forward-facing child seat is in contact with the seatback of the vehicle seat. In this case, the child seat may not always rest on the seat base of the vehicle seat.



The ISOFIX anchorage points have been exclusively designed for child seats with the ISOFIX system. Never fit a different type of child seat, seat belt or other objects to these anchorage points. Check that nothing is obstructing the anchorage points. If your vehicle has been involved in a road accident, have the ISOFIX anchorage points checked and replace your child seat.

## CHILD SEATS

2

### Fitting a child seat, general information

Some seats are not suitable for fitting child seats. The following diagrams show you how to attach a child seat.

The types of child seats indicated may not be available. Before using a different child seat, check with the manufacturer that it can be fitted.



Fit the child seat in a rear seat.

Check that when installing the child seat in

the vehicle it is not at risk of coming loose from its base.

If you have to remove the headrest, check that it is correctly stored so that it does not come loose under harsh braking or impact.

Always attach the child seat to the vehicle even if it is not in use so that it does not come loose under harsh braking or impact.

### In the Front seat

The laws concerning children travelling in the front passenger seat differ in

every country. Consult the current legislation and observe the indications on the following diagrams.

Before fitting a child seat in this seat (if authorised) :

- lower the seat belt as far as possible;
- move the seat as far back as possible;
- gently tilt the seatback away from vertical (approximately 25°);
- on equipped vehicles, raise the seat base as far as possible.

After installing the child seat, when this is possible, you can move the vehicle seat forward if necessary (so as to leave enough space in the rear seats for passengers or other child seats). For a rear-facing child seat, do not let it touch the dashboard or move it to the furthest forward position.

Do not change other settings after installing the child seat.



**RISK OF DEATH OR SERIOUS INJURY:** before fitting a rear-facing child seat in this seat, make sure that the front passenger airbag has been deactivated.

### In the rear side seat

A carrycot can be installed across the vehicle and will take up at least two seats. Position the child with his or her feet nearest the door.

Move the front seat as far forward as possible to install a rear-facing child seat, then move back the seat in front as far as it will go, although without allowing it to come into contact with the child seat.

For the safety of the child in the forward facing position :

- move the relevant seat backwards as far as possible ;
- move the seat in front of the child forwards, and set the position of the seatback to avoid contact between the seat and the child's legs.



Make sure that the child seat or the child's feet do not prevent the front seat from locking correctly.

Always remove the headrest from the rear seat on which the child seat is positioned. If necessary, position the rear seat as far back as possible.

This must be done before fitting the child seat. Check that the child seat is

## CHILD SEATS

resting against the back of the rear seat.



Fit the child seat in a rear seat wherever possible.

To install an ISOFIX seat in this seat, unbuckle the seat belt by hand before engaging the bolts.



### **Installing a booster seat (group 2 or 3)**

Check the operation (rolling up) of the seat

belt → 61.

Adjust the seat belt by positioning :

- the shoulder strap on the child's shoulder without touching the neck ;
- the lap belt so that it lies flat on the thighs and against the pelvis.

If necessary, adjust the position of the vehicle seat.



Fitting a seat ISOFIX in the rear-left seat means the middle seat cannot be used. The central seat belt will no longer be either accessible or useable.

# CHILD SEATS

## Attachment by seat belt

Installation visual for the four-seat version

2

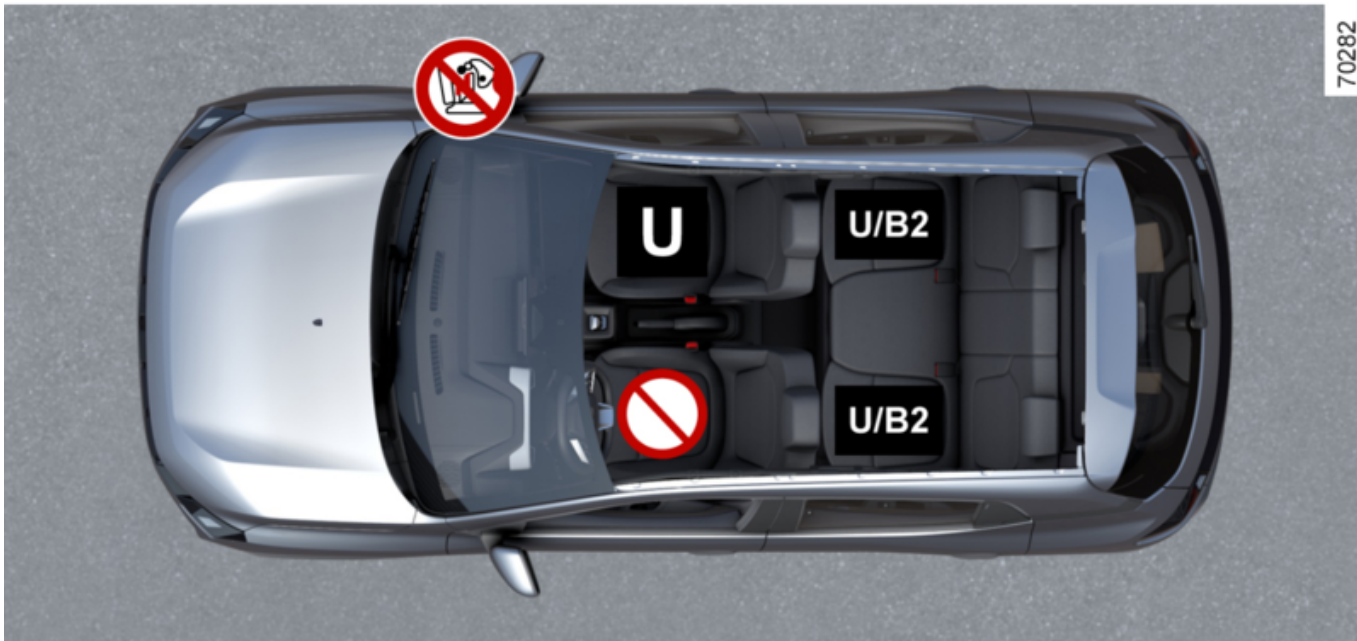

70282

## CHILD SEATS



**RISK OF DEATH OR SERIOUS INJURY:** before fitting a rear-facing child seat in this seat, make sure that the front passenger airbag has been deactivated → 92.

2



Using a child safety system which is not approved for this vehicle will not correctly protect the baby or child. They risk serious or even fatal injury.

### Child seat attached using the belt



Check the status of the airbag before fitting a child seat or allowing a passenger to use the seat.



Seat which allows a child seat with « Universal » approval to be attached by a seat belt.



Seat not suitable for fitting child seats.



Seat which allows a child seat with « B2 » approval to be attached by a seat belt.



Check that your child is always strapped in and that the belt or safety harness used is correctly set and adjusted → 61.

If necessary, adjust the seat position accordingly.

The table below summarises the information shown in installation visual to ensure the applicable regulations are respected.

## CHILD SEATS

2

Four-seat version				
Type of child seat	Weight of the child	Front passenger seat		Rear side seats
		with airbag without deactivation	without airbag or with airbag deactivated	
Transverse carrycot Group 0	< 10 kg	X	X	U (4)
Rear-facing seat Group 0 or 0+	< 10 kg and < 13 kg	X	U (2) (3)	U (5)
Rear-facing seat Group 0+ and 1	< 13 kg and 9 to 18 kg	X	U (2) (3)	U (5)
Forward-facing seat Group 1	9 to 18 kg	U (1) (3)	X	U (6)
Booster seat Group 2 and 3	15 to 25 kg and 22 to 36 kg	U (1) (3)	X	U/B2 (6)



**(1) RISK OF DEATH OR SERIOUS INJURY** : never fit a child seat on the front seat if the vehicle has a passenger airbag which cannot be deactivated.

**(2) RISK OF DEATH OR SERIOUS INJURY** : before fitting a rear-facing child seat on the front passenger seat, check that the airbag has been deactivated → 92.

**X** = Seat not suitable for fitting child seats.

**U** = Seat allowing a child seat with « Universal » approval to be attached by seat belt ; check that it can be fitted correctly.

## CHILD SEATS

- (3) Move the vehicle seat in the rearmost and highest position and tilt the backrest slightly (25°)
- (4) A carrycot can be installed across the vehicle and will take up at least two seats. Position the child with his or her feet nearest the door.
- (5) In order to install a rear-facing child seat, move the front seat as far forward as possible, then move the front seat back as far as it will go, without allowing it to come into contact with the child seat. Raise the headrest or remove it.
- (6) Forward facing child seat ; position the seatback of the child seat in contact with the seatback of the vehicle seat. Adjust the height of the headrest or remove it if necessary ; do not push the seat in front of the child more than halfway back on its runners and do not recline the seatback more than 25°.

### Installation visual for the utility version

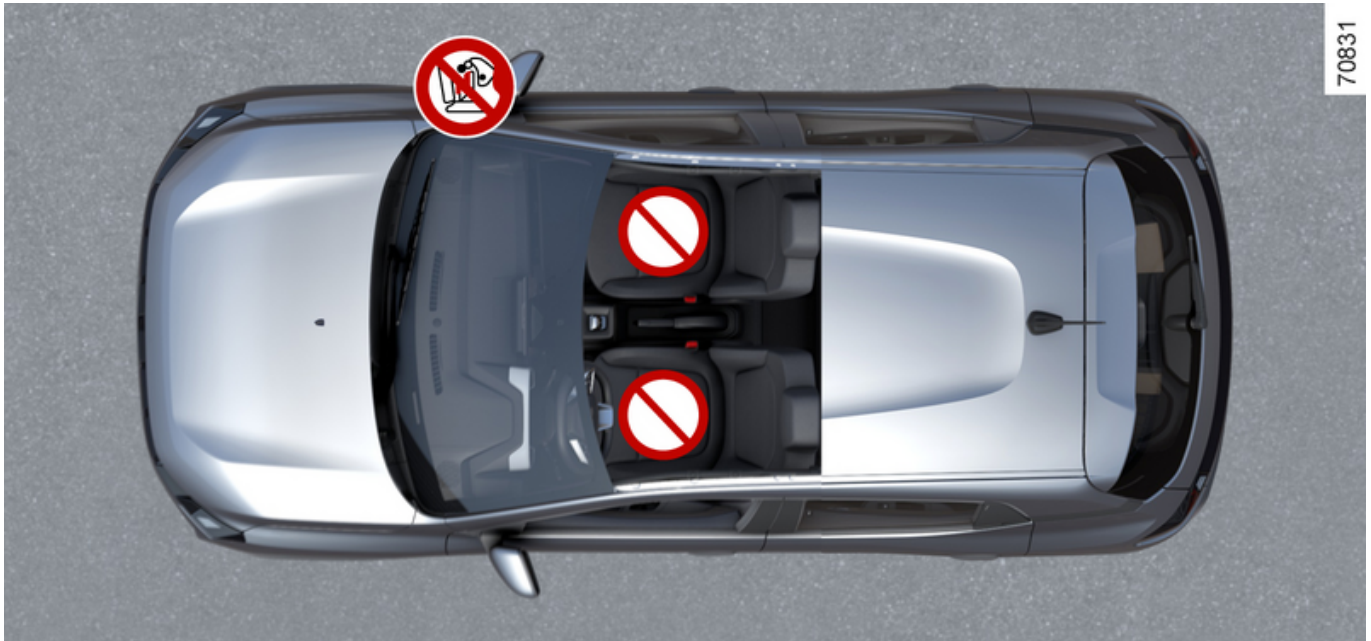

## CHILD SEATS

### Child seat attached using the belt



Check the status of the airbag before allowing a passenger to use the seat.



Seat not suitable for fitting child seats.



For utility version, It is strictly forbidden to install a child seat on the passenger seat.

## CHILD SEATS

### Attachment with the ISOFIX system

Installation visual for the four-seat version

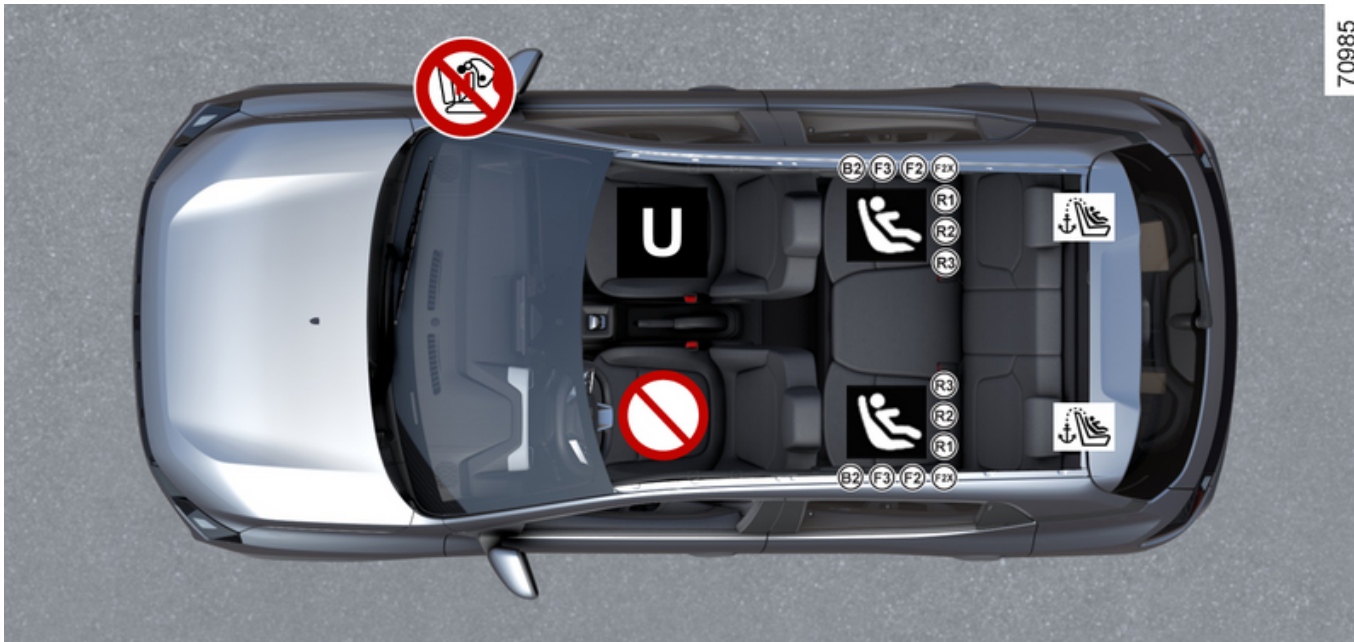

2

70985



Using a child safety system which is not approved for this vehicle will not correctly protect the baby or child. They risk serious or even fatal injury.

## CHILD SEATS

Child seat attached using the ISOFIX system.



Seat which allows an ISOFIX child seat to be attached.



The rear seats are fitted with an anchorage point which allows a forward-facing ISOFIX child seat with universal approval to be attached. The anchorage points are located on the backs of the rear seats.



Seat not suitable for fitting child seats.



Check the status of the airbag before fitting a child seat or allowing a passenger to use the seat.



Check that your child is always strapped in and that the belt or safety harness used is correctly set and adjusted  
→ 61.  
If necessary, adjust the seat position accordingly.



Fit the child seat in a rear seat wherever possible.  
To install an ISOFIX seat in this seat, unbuckle the seat belt by hand before engaging the bolts.

The table below summarises the information shown in installation visual to ensure the applicable regulations are respected.

Four-seat version				
Type of child seat	Weight of the child	Seat size ISOFIX [FIXTURE]	Front passenger seat	Rear side seats
<b>Carrycot fitted across the vehicle</b> Group 0	< 10 kg	L1 [F], L2 [G]	X	X

## CHILD SEATS

Four-seat version				
Type of child seat	Weight of the child	Seat size ISOFIX [FIXTURE]	Front passenger seat	Rear side seats
<b>Rear-facing seat</b> Groups 0 or 0 +	< 10 kg and < 13 kg	R1 [E]	X	IL (1)
<b>Rear-facing seat</b> Groups 0+ and 1	< 13 kg and 9 to 18 kg	R3 [C], R2 [D]	X	IL (1)
<b>Forward-facing seat</b> Group 1	9 to 18 kg	F3 [A], F2 [B], F2X [B1]	X	IUF - IL (2)
<b>Booster seat</b> Groups 2 and 3	15 to 25 kg and 22 to 36 kg	B2	X	IUF - IL (2)
<b>I-Size seat</b>			X	X

**X**= Seat not suitable for fitting child seats ISOFIX.

**IUF/IL** = On equipped vehicles, seat which allows a child seat with « Universal »/« Semi-universal » or « vehicle specific » approval to be fitted using the ISOFIX system ; check that it can be fitted correctly.

**(1)** If necessary, position the vehicle seat as far back as possible. Move the front seat as far forward as possible to install a rear-facing child seat, then move back the seat in front as far as it will go, although without allowing it to come into contact with the child seat.

**(2)** In all situations, remove the rear headrest of the seat on which the child seat is positioned. This must be done before fitting the child seat ➔ 59. Move the seat in front of the child forwards, move the seatback forward to avoid contact between the seat and the child's legs.

The size of the ISOFIX child seat is indicated by a letter :

- F3, F2, F2X [A, B, B1] : for forward-facing seats in group 1 (9 to 18 kg) ;
- R3, R2, R2X [C, D] : shell seat or rear-facing seats in group 0+ (less than 18 kg) or group 1 (9 to 18 kg) ;
- R1 [E] : for rear-facing seats in group 0 (less than 10 kg) or 0+ (under 13 kg) ;
- L1, L2 [F, G] : carrycots in group 0 (under 10 kg) ;
- B2 : boosters in groups 2 and 3 (15 to 25 kg and 22 to 36 kg).

## CHILD SEATS

Installation visual of the utility version

2

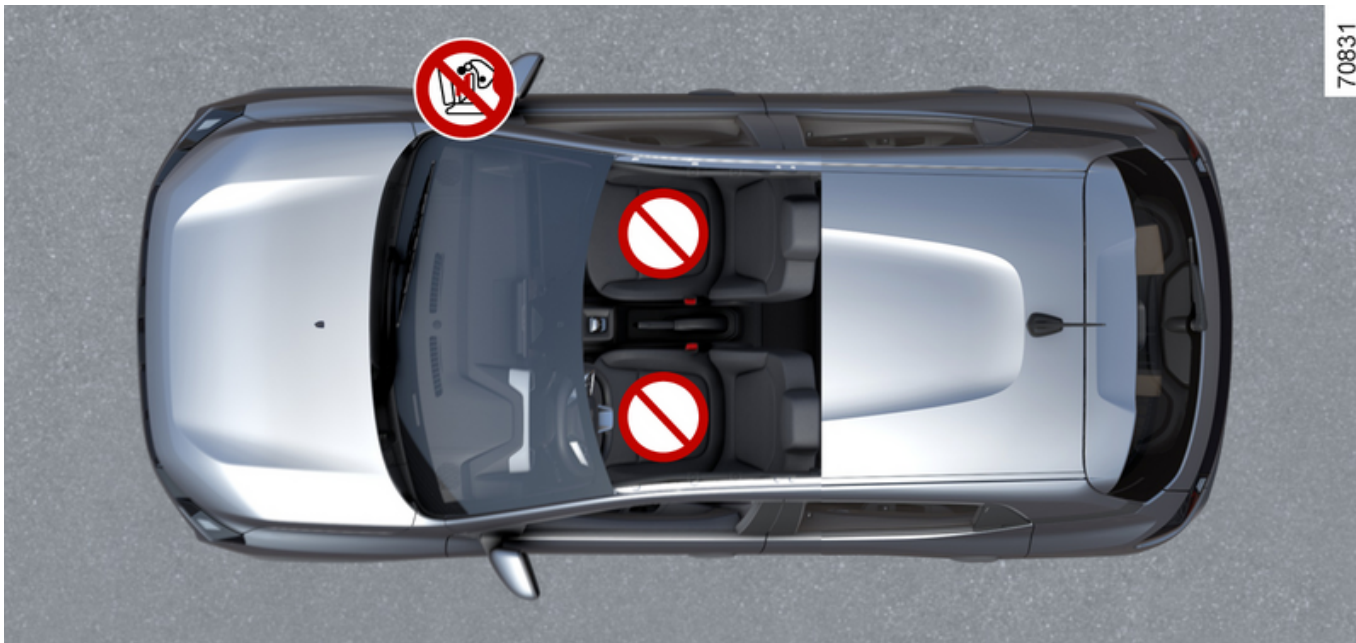

70831



Using a child safety system which is not approved for this vehicle will not properly protect the baby or child. They risk serious or even fatal injury.



Check the status of the airbag before or allowing a passenger to use the seat.

## CHILD SEATS



Seat which does not allow a child seat to be fitted.



For utility version, It is strictly forbidden to install a child seat on the passenger seat.

# CHILD SAFETY: DEACTIVATING, ACTIVATING THE FRONT PASSENGER AIRBAG

## Warnings

2



The passenger airbag may only be activated or deactivated while the vehicle is stationary with the ignition off.

## Deactivating the front passenger airbag



(depending on the vehicle)

Before installing a child seat on the front passenger seat:

- check that the child seat can be installed on this seat;
- it is essential to deactivate the airbag for a rear-facing child seat.

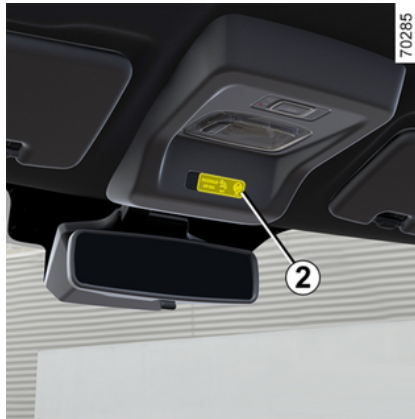

To deactivate the airbag: stationary vehicle ignition switched off, push and turn lock 1 to the OFF position.

With the ignition on, you must check

that the warning light  is lit on the display 2.

This light remains permanently lit to let you know that you can fit a child seat.



## DANGER

As the deployment of the front passenger airbag is not compatible with the positioning of a rear-facing child seat, **NEVER fit a rear-facing child restraint system on a seat protected by an ACTIVATED front AIRBAG.** This can cause the **CHILD'S DEATH or SERIOUS INJURY.**

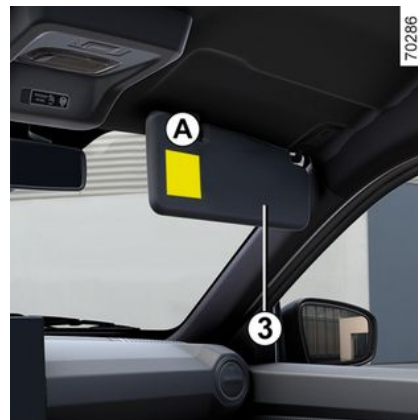

# CHILD SAFETY: DEACTIVATING, ACTIVATING THE FRONT PASSENGER AIRBAG



The markings on the dashboard and labels **A** on each side of the passenger sun visor **3** (example : label shown above) remind you of these instructions.



## Activating the front passenger airbag



(depending on the vehicle)

You should reactivate the airbag as soon as you remove the child seat from the front passenger seat to ensure the protection of the front passenger in the event of an impact.

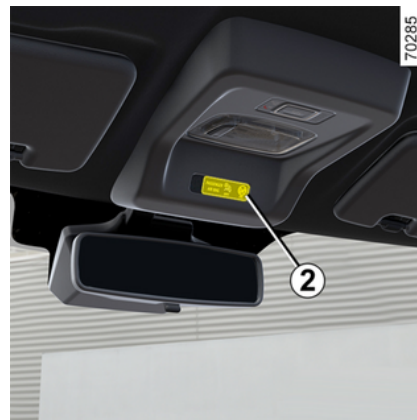

**To reactivate the airbag: vehicle stationary, ignition switched off,** press and turn the lock to **1** position ON.

With the ignition switched on, you **must** check that the warning light



**1** is off and that the warning light



**2** comes on the display **2** after each start-up for around 60 seconds.

The front passenger airbag is activated.

## DRIVING POSITION

### Operating faults

In the event of a fault with the front passenger airbag activation/deactivation system, the



and



warning lights are displayed on the instrument panel. Switch off the ignition and check the position of the lock **1**.

Switch the ignition back on: the warning lights go out.

If the problem persists, it signals a system failure. In this case, it is prohibited for a rear-facing child seat to be fitted to the front passenger seat or for any other passenger to occupy the seat.

Contact your approved Dealer as soon as possible.

2



# DRIVING POSITION

Driving position: left-hand drive

2

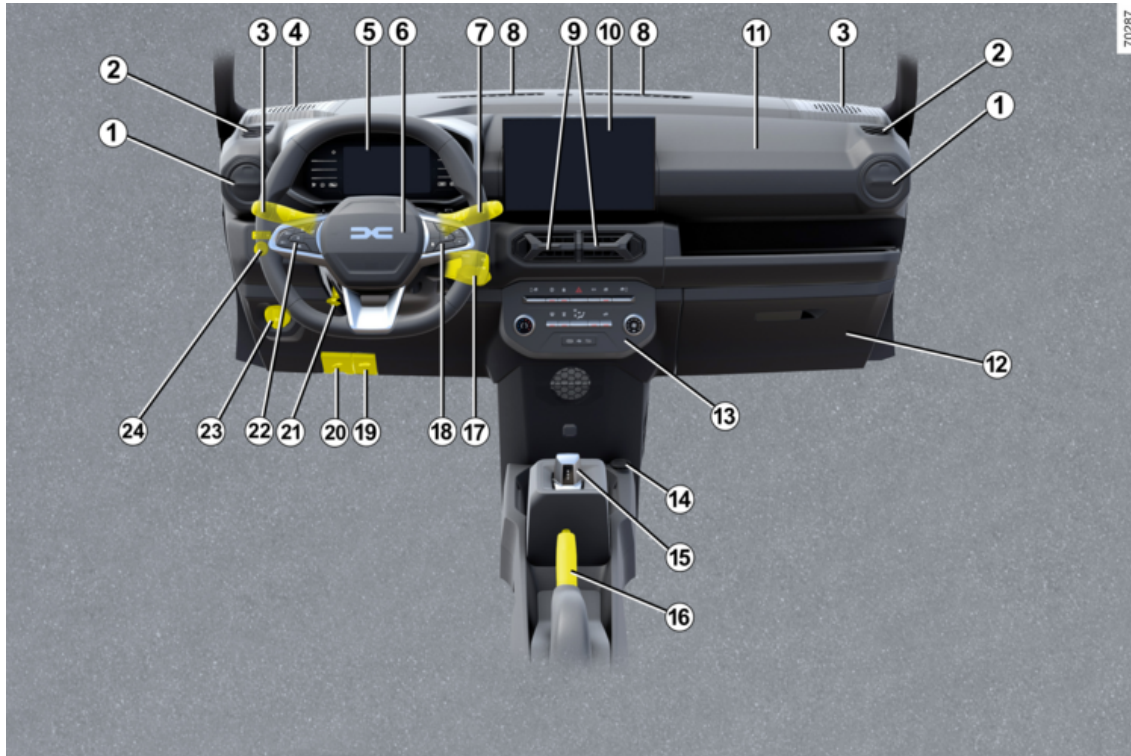

## DRIVING POSITION

### **The presence of the equipment DEPENDS ON THE VEHICLE VERSION AND COUNTRY.**

- 1.** Side air vents.
- 2.** Side demister outlet.
- 3.** Stalk for:
  - direction indicator lights;
  - exterior lights;
  - rear fog lights.
- 4.** Side speakers.
- 5.** Instrument panel.
- 6.** Location for driver's airbag and horn.
- 7.** Stalk for:
  - windscreen washer/ wiper;
  - rear screen washer/ wiper.
- 8.** Central demister outlet.
- 9.** Centre air vents.
- 10.** Location for Navigation system.
- 11.** Location for passenger airbag.
- 12.** Glove box.
- 13.** Controls for:
  - electric window;
  - ECO mode;
  - hazard warning lights;
  - heating or air conditioning;
  - door central locking;
  - My Safety.
- 14.** Accessories socket.
- 15.** Gear shifter.
- 16.** Handbrake.
- 17.** Radio remote control.
- 18.** Controls for:
  - trip computer information readout;
  - remote radio and navigation system.
- 19.** Bonnet release control.
- 20.** Electric charging flap release control.
- 21.** Control for adjusting steering wheel height.
- 22.** Main switch and controls for cruise control/speed limiter.
- 23.** Headlamp beam adjustment.
- 24.** Door mirror adjustment control.

# DRIVING POSITION

Driving position: right-hand drive

2

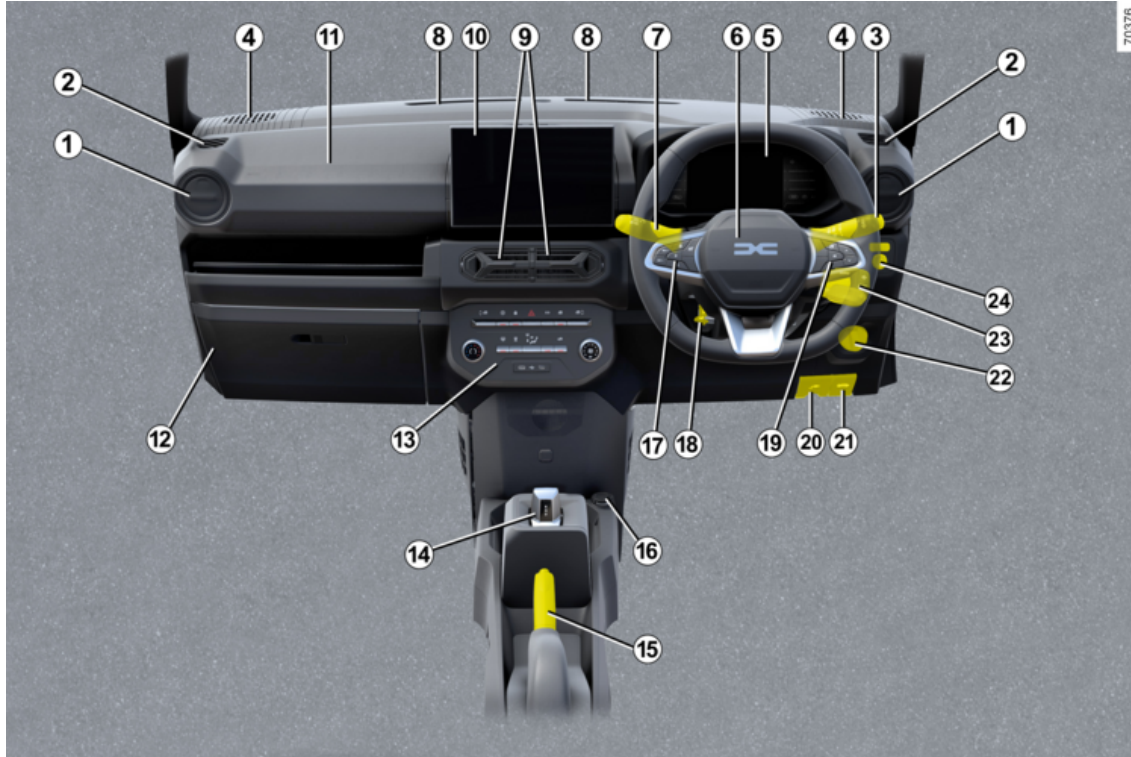

## DRIVING POSITION

### **The presence of the equipment DEPENDS ON THE VEHICLE VERSION AND COUNTRY.**

- 1.** Side air vents.
- 2.** Side demister outlet.
- 3.** Stalk for:
  - direction indicator lights;
  - exterior lights;
  - rear fog lights.
- 4.** Side speakers.
- 5.** Instrument panel.
- 6.** Location for driver's airbag and horn.
- 7.** Stalk for:
  - windscreen washer/ wiper;
  - rear screen washer/ wiper.
- 8.** Central demister outlet.
- 9.** Centre air vents.
- 10.** Location for Navigation system.
- 11.** Location for passenger airbag.
- 12.** Glove box.
- 13.** Controls for:
  - electric window;
  - ECO mode;
  - hazard warning lights;
  - heating or air conditioning;
  - door central locking;
  - My Safety.
- 14.** Gear shifter.
- 15.** Handbrake.
- 16.** Accessories socket.
- 17.** Main switch and controls for cruise control/speed limiter.
- 18.** Control for adjusting steering wheel height.
- 19.** Controls for:
  - trip computer information readout;
  - remote radio and navigation system.
- 20.** Electric charging flap release control.
- 21.** Bonnet release control.
- 22.** Headlamp beam adjustment.
- 23.** Radio remote control.
- 24.** Door mirror adjustment control.

# TRIP COMPUTER

## General information

2

### Trip computer A



Depending on the vehicle, this includes the following functions:

- mileage;
- trip settings;
- information messages;
- operating fault messages (related to

the  warning light);

- warning messages (related to the

 warning light).

Press switch **1** and select the functions by pressing switch **2** and **3** by pressing the button **4** to select the func-

tion (the display depends on the vehicle equipment and country):

#### From the instrument panel A:

a) trip settings:

- average energy consumption since the last reset and current energy consumption;
- distance travelled since last reset.

b) reset the pressure of the tyres;

c) service interval;

d) trip log, operating faults and information messages.

### Resetting the trip mileage

With the trip parameters selected as the display, press and hold the **4** switch « OK » until the display resets to zero.

### Interpreting some of the values displayed after resetting

The values showing average fuel consumption, range and average speed will become more stable and reliable the further you travel after pressing the reset button.

For the first few miles after pressing the reset key you will notice that the range increases as you travel.

This range takes into account the average fuel consumption since the last time the reset button was pressed.

However, average consumption can decrease when:

- the vehicle stops accelerating;
- when driving from an urban area on to the open road.

# TRIP COMPUTER

## Journey parameters

The display of information shown below **DEPENDS ON THE VEHICLE EQUIPMENT AND COUNTRY.**

2

Examples of selections	Interpreting the display selected
	<b>a) Trip settings.</b>
13,4 kWh	<b>Current energy consumption.</b>
12,8 kWh/100 km	<b>Average energy consumption.</b> The value is displayed after having travelled at least 400 metres since the last reset.
1284,7 km	<b>Distance travelled</b> since last reset.
<b>Tyre pressure init. long press</b>	<b>b) Reset the pressure of the tyres</b> → 140

Examples of selections	Interpreting the display selected
Service in 1,200 miles (1,936 km) or 3 months	<b>c) Service interval.</b> Distance remaining until the next service (displayed in miles or kilometres), then when the service nears, several scenarios are possible: – interval less than <b>932 miles (1,500 km) or one month</b> : the « Service in » message is displayed along with the remaining distance or time; – when a service is due, the « Service due » message is displayed accompanied by the first limit (distance or time); – range equal to <b>0 miles (0 km) or date of service reached</b> : the message « Service required » is displayed accompanied by the  warning light. The vehicle requires a service as soon as possible.

## TRIP COMPUTER

2

Examples of selections	Interpreting the display selected
<p><b>Resetting the display after the service in accordance with the maintenance schedule.</b></p> <p>The service interval must only be reset after a service which complies with the recommendations in the maintenance schedule.</p> <p><b>Special feature:</b> to reset the service interval, press and hold one of the display reset buttons for approximately 10 seconds until the display shows the service range permanently.</p>	
Examples of selections	Interpreting the display selected
Settings Press "OK"	<p><b>d) Vehicle settings customisation menu.</b></p> <p>➔ 110</p>
WARNING: Check Braking System	<p><b>e) Trip log.</b></p> <p>Successive display:</p> <ul style="list-style-type: none"><li>– information messages;</li><li>– operating fault messages.</li></ul>

# TRIP COMPUTER

## Information messages

These can help in the vehicle starting phase, or give information about a selection or a driving status. Examples of information messages are given in the following pages.

2

Examples of messages	Interpreting the display selected
<b>“Disconnect cable to start”</b>	Indicates that the charging cord is still plugged into the vehicle.
<b>“Connect one plug only”</b>	Indicates that there are two gun plugged at the same time. Please ensure to connect one plug only.
<b>“Check connections”</b>	Indicates that there is plug connection problem, need to check the plug connection.
<b>“Power cut while charging”</b>	Indicates that the power supply cut off during charging. Please get the support from the power station manufacturers.
<b>“Parking Brake ON”</b>	Indicates that the parking brake has been applied.
<b>“Station Voltage inconsistent”</b>	the voltage output range of this station is not consistency with current battery voltage of your vehicle, need to find another proper station.
<b>“Station Current inconsistent”</b>	the current output range of this station is not consistency with your vehicle, need to find another proper station.

# TRIP COMPUTER

## Operating fault messages

2

These appear with the  warning light and mean that you should drive very carefully to an authorised dealer as soon as possible. If you fail to follow this recommendation, you risk damaging your vehicle.

They disappear when the display selection key is pressed or after several seconds and are stored in the computer log. The



warning light stays on. Examples of operating fault messages are given in the following pages.

Examples of messages	Interpreting the display selected
« <b>WARNING: Check Airbag</b> »	Indicates a fault in the restraint system in addition to the seat belts. In the event of an accident, it is possible that they may not be triggered.
« <b>Check vehicle</b> »	Indicates a fault on one of the pedal sensors or in the 12 V battery management system.
« <b>WARNING: Check Braking System</b> »	Indicates wear or the need to check the braking system.
« <b>Check Vehicle plug</b> »	Indicates overheating at the vehicle-side charging socket. Wait for about 20 minutes and try again. If this does not work, contact an authorised dealer.
« <b>Check Electric System</b> »	Indicates a fault in the traction system.
« <b>Battery charging impossible</b> »	Indicates a fault on the traction battery recharge system.

# TRIP COMPUTER

## Warning messages

These appear with the **STOP** warning light and require you to stop immediately, for your own safety, as soon as traffic conditions allow. Stop your engine and do not restart it. Call an approved Dealer.

Examples of warning messages are given in the following pages. **Note** : the messages appear on the display either individually or alternately (when there are several messages to be displayed), and may be accompanied by a warning light and/or a beep.

Examples of messages	Interpreting the display selected
« <b>WARNING: Braking System</b> »	Indicates a fault in the braking system.
« <b>WARNING: Power Steering</b> »	Indicates a fault in the steering.
« <b>Electric motor failure</b> »	Indicates that the vehicle is losing power.
« <b>WARNING : Electric System</b> »	Indicates a fault in the electric system.
« <b>Puncture</b> »	Indicates that at least one wheel is punctured or severely underinflated.

# TRIP COMPUTER

## Displays and indicators

2

### Instrument panel A



It lights up when the ignition is switched on.

In some cases, the appearance of a warning light is accompanied by a message.

For vehicles fitted with a multimedia screen, refer to the equipment instructions.

For vehicles not fitted with a multimedia screen → 111.

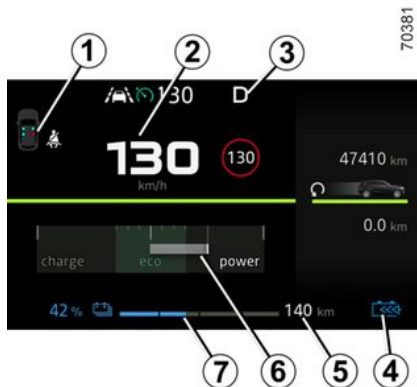

**Seat belt reminder warning light 1**

**Speedometer 2**

**Driving mode indicator 3**

D : Drive mode

N : Neutral mode

R : Reverse mode

B : Braking mode

**Regenerative braking level warning light 4**

**Battery information 5 (estimated range).**

**Econometer 6**

The display indicates the level of energy.

**« 230 V » traction battery level remaining 7**

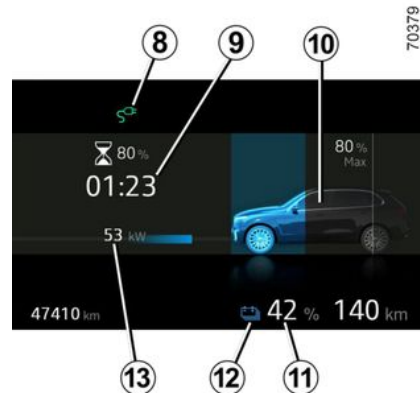

**Charging lead plugged in warning light 8**

This comes on when the charging cable is plugged into the vehicle.

**Remaining charging time 9**

**Charge level 10**

The gauge indicates the level of energy remaining.

**Traction battery level 11**

**Reserve threshold**

When the traction battery charge reaches approximately 7% or, depending on the vehicle, approximately 12%,

the gauge and indicator light 12  appear in yellow, accompanied by a beep.

# TRIP COMPUTER

To optimise your range → 137.

## Immobilisation threshold imminent

When the charge level reaches about 4% or, depending on the vehicle, about 6%, a beep will sound again and the gauge will light up in red or, depending on the vehicle, 30 seconds after the gauge lights up in red.

When the charge level reaches 3.5% or, depending on the vehicle, approximately 5%, the range value is no longer displayed. Engine performance gradually decreases until the vehicle comes to a halt → 228.

## Power entering the vehicle 13



## ECO mode 14

## Information on driving aids 15

## External temperature 16

Indicates the external temperature.



Information area 17, depending on the vehicle, browse using the control 18 to select various widgets on the instrument panel A:

- trip computer information (mileage recorder, consumption, etc.);
- telephone, multimedia (audio source currently playing, etc.) information;
- vehicle information (warning messages, etc.);
- ...



EV Autonomy widget page displays the bar of autonomy minimum and maximum range 19

EV Autonomy widget page displays the current autonomy and unit 20

# TRIP COMPUTER

2



70384

Consumption widget page displays the Instant consumption gauge **21** SOC (State of charge) bar displays the Current level of vehicle battery available charge **22**

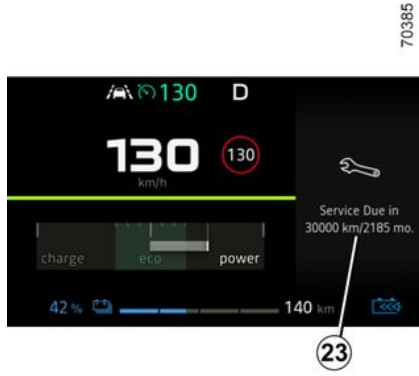

70385

Remaining distance for maintenance and Remaining days for maintenance **23**

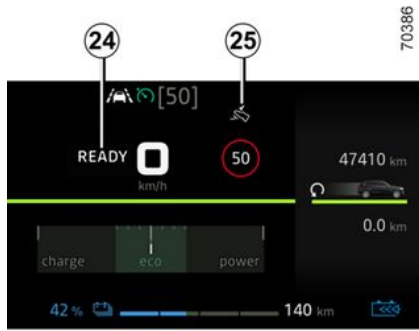

70386

**Message indicating that the vehicle is ready for driving **24**.**

The READY message appears when the engine starts and disappears when the vehicle speed exceeds approximately 3 mph (5 km/h).

**Brake press indicator **25****

Indicates that brake pedal must be pressed to change the drive mode (**R**, **N**, **D** or **B**).



70387

Driving style indicator **26** → 135.

# TRIP COMPUTER

70388

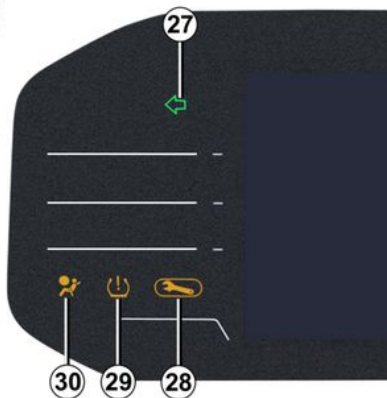

Direction change indicators **27**

Warning light **28** → 113

Tyre low pressure warning light **29**  
→ 140

Airbag warning light **30** → 66

70389

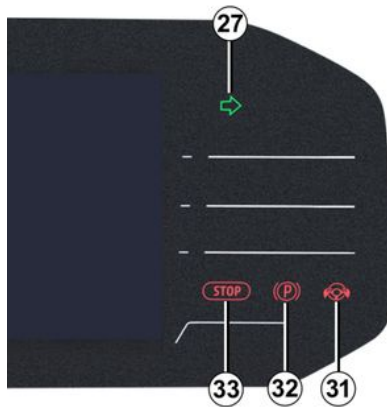

Hands off steering wheel detection  
warning light **31** → 150

Parking brake warning light **32**  
→ 132

Urgent stop warning light **33** → 113

## Instrument panel in miles



2

(option to switch to km/h)

**Vehicles not fitted with a multimedia screen**

- With the ignition off, press the **27** switch as many times as required to reach the « Settings » world;
- press the **28** or **27** control repeatedly to reach « Vehicle settings » and press the **28** « OK » switch;
- press the **28** or **27** control repeatedly to reach « INSTRUMENT PANEL » and press the **28** « OK » switch;
- press the **28** or **27** control repeatedly to reach the « Unit: km/h » (or « Unit: mph » if required), then press the **28** « OK » switch.

## TRIP COMPUTER

### Vehicles fitted with a multimedia screen.

Please refer to the multimedia instructions to select the unit.

**Note:** in both cases, once the battery is switched off, the on-board computer automatically returns to the original unit of measurement.

To return to the previous mode, repeat the same operation.

Please refer to the multimedia instructions for further information.



To use certain driving aid functions, it is necessary to change the unit of measurement on the instrument panel in order to obtain the appropriate information when driving in a country where the speed units differ from those set as default on your vehicle.



For safety reasons, carry out any adjustments while the vehicle is stationary.

### Vehicle settings personalisation menu

Depending on the vehicle equipment, this function allows you to activate/ deactivate and adjust some of the vehicle's functions.

### Vehicles fitted with a multimedia screen 1



#### Accessing the settings menu

Refer to the various multimedia instructions for information on accessing the settings.

#### Adjusting the settings

Select a menu then the function to be modified (the display depends on the vehicle equipment and country):

a) « Access »:

- Auto door lock while driving;
- Access and start by phone;

b) « Welcome »:

- Internal Sound sequence;
- Internal light function;

c): « Wiping »:

- Rear wiping when in reverse gear;

Depending on the function, select:

- « ON » or « OFF » to activate or deactivate it.

Please refer to the multimedia instructions for further information.



For safety reasons, carry out any adjustments while the vehicle is stationary.

# TRIP COMPUTER

## Vehicles not fitted with a multimedia screen



Accessing the settings menu on display **2**.

Vehicle stationary:

- press the switch **3** repeatedly to access the  menu;
- repeatedly press control **4** or **5** to access the « Setting » menu.
- Press the **OK** switch **6**;

### Adjusting the settings

Navigate using control **4** or **5** to select the function to be modified and press control **6** « **OK** » to confirm (display may vary according to vehicle equipment and country):

- a) « VEHICLE SETTING »:
  - DASHBOARD:
    - Language;
    - Unit.
- b) « VEHICLE »:
  - Rear Wiper When Reverse;
  - Traction control.
- c) « PARKING ASSIST »:
  - Bip volume;
- d) « DRIVING ASSIST »:
  - Lane Departure Sensitivity;
  - Lane Departure Vibration;
  - Lane Keeping Sensitivity;
  - Active braking;
  - Active Braking Sensitivity;
  - Dashed line correction.
- e) « MY SAFETY PERSONALISATION »:
  - Speed alert;
  - Lane Keeping;
  - Vigilance.
- f) « ACCESS »:
  - Lock Doors When Moving;
- g) « RESET »:



Confirmation.

Once a line has been selected, press the switch **6** « **OK** » to modify the function

h) « EXIT »:

- Audio setting;
- Phone setting;
- Time setting;
- Brightness adj.

If you select « PARKING ASSIST » then « VOLUME » or « DASHBOARD » then « LANGUAGE », you will be able to make a selection (Park Assist sound volume or instrument panel language). In this case, make your selection and confirm it by pressing the switch **6** « **OK** », the selected

value is shown by a  in front of the line.

To exit the menu, press the switch **4** or **5** to reach « BACK » and confirm by pressing switch **6** « **OK** ». It may be necessary to carry out this operation more than once.



The vehicle settings personalisation menu cannot be used when driving. At a speed exceeding 12 mph (20 km/h), the instrument panel display switches automatically back to trip computer and warning system mode.

## TRIP COMPUTER

### Clock and outdoor temperature



#### Vehicles fitted with a multimedia screen.

The time and outdoor temperature are displayed on the multimedia screen **1**. Refer to the multimedia instructions.



#### Vehicles not fitted with a multimedia screen

- press the switch **2** as many times as required to reach the  menu;
- repeatedly press control **3** or **4** to reach the « Time setting » menu. press the « OK » switch **5**;
- press and hold switch **5** « OK » until the time display flashes. Set the hour using the **3** or **4** control, then wait for three seconds: the minutes will flash.
- set the minutes using the **3** or **4** control, then wait for three seconds: the flashing stops and the time setting is complete.

### Exterior temperature indicator

#### Special feature:

When the outside temperature is between  $-3^{\circ}\text{C}$  and  $+3^{\circ}\text{C}$ , the  $^{\circ}\text{C}$  figures flash (this indicates a risk of ice formation).

 If the power supply is cut (battery disconnected, supply wire cut, etc.), the clock must be reset. We recommend that you do not adjust these settings while driving.



#### Exterior temperature indicator

As ice formation is related to climatic exposure, local air humidity and temperature, the external temperature alone is not sufficient to detect ice.

## WARNING LIGHTS

The presence and operation of the warning lights **DEPEND ON THE EQUIPMENT AND COUNTRY.**

### Instrument panel A



In some cases, the appearance of a warning light is accompanied by a message.



If no lights or sounds are apparent, this indicates a fault in the instrument panel. This indicates that it is essential to stop immediately (as soon as traffic conditions allow). Ensure that the vehicle is correctly immobilised and contact an approved Dealer.



Warning light  means you should drive **very carefully to an authorised dealer as soon as possible.** If you fail to follow this recommendation, you risk damaging your vehicle.



For your own safety, the **STOP** warning light requires you to stop immediately, as soon as traffic conditions allow. Switch off the engine and do not restart it. Call an approved Dealer.



**Side light tell-tale light**



**High beam headlight warning light**



**Dipped beam headlight tell-tale light**



**Rear fog light tell-tale light**



**Left-hand direction indicator tell-tale light**



**Right-hand direction indicator tell-tale light**



**Door(s) open warning light**

This warning light comes ON, if any of the door is opened, warning light will come ON indicating the exact door location in open condition.



**Charging cord plugged in warning light**

This warning light comes ON, when the charging cord is plugged into the vehicle.



**Charging programming warning light**

## WARNING LIGHTS



**Air conditioning program indicator**



**Secondary 12V Battery low charge warning light**

This warning light comes ON, when ignition is ON and goes after few seconds. If it comes on when you are driving, it indicates that the circuit has discharged. Contact your approved dealer as soon as possible.



**Service warning light**

This warning light comes ON, when the ignition is switched on and goes out as soon as the engine is started. It can light up in conjunction with other warning lights and/or messages on the instrument panel.

It means you should **drive very carefully** to an approved dealer as soon as possible. If you fail to follow this recommendation, you risk damaging your vehicle.



**Warning light**

If it appears in red during driving and is

accompanied by the **STOP** indicator light, you must, for your safety, stop as soon as traffic conditions allow. Switch off the engine and do not restart it. Call an approved dealer. If it appears in yel-

low during driving and is accompanied

by the  warning light, visit an approved dealer as soon as possible.

**Meanwhile, drive with care.**

If you fail to follow this recommendation, you risk damaging your vehicle.



**Urgent stop warning light**

This warning light comes ON, when the ignition is switched on and goes out as soon as the engine is started. It lights up at the same time as other warning lights, and is accompanied by a beep. It requires you to stop immediately, for your own safety, as soon as traffic conditions allow. Switch off the engine and do not restart it. Contact an approved dealer.



**Anti-lock braking warning light**

This warning light comes ON, when the ignition is switched on and then goes out after few seconds.

If it does not go out after the ignition is switched on, or This warning light comes ON, when driving, there is a fault with the ABS. The brake system is assured as in a vehicle with out an ABS system.

Contact an approved Dealer as soon as possible.



**Speed limiter warning light**  
➔ 173



**Cruise control warning light**  
➔ 176



**Seat belt reminder warning light**

If, after the engine is started, the driver's or front passenger's (if applicable) seat belt is not fastened/correctly in position and the vehicle has reached approximately 12 mph (20 km/h), This warning light comes ON, in the instrument panel and a beep will sound for about two minutes ➔ 62.

**Note :** an object placed on the passenger seat base may activate the warning light in some cases.



**Airbag warning light**

This warning light comes ON, when the ignition is switched on and goes out after a few seconds.

If it does not goes out when the ignition is switched on, or comes on when the engine is running, there is a fault in the system.

Contact your approved dealer as soon as possible

## WARNING LIGHTS



### Tyre under-inflation warning light

This lights up when the ignition is switched on or when the engine starts, then disappears after a few seconds

➔ 140.



### Traction battery low level warning light

This warning light comes ON, when ignition is switched on and goes off after few seconds. It will be ON continuously, in vehicle running condition.

When driving, if it blinks, it indicates the power level is low. The vehicle needs to be charged as soon as possible. Please contact an authorised dealer if unable to increase the level of battery even if you connect the charge plug.



### Limited performance warning light

This warning light comes ON, when ignition is switched on and goes off after few seconds.

This appears when the traction battery temporarily does not deliver its nominal power. During this period, vehicle performance is reduced.

Opt for a smoother driving style until the warning light disappears.



### Electronic stability program and traction control system warning light

This warning light comes ON, when the ignition is ON and goes off after a few seconds. There are several reasons for the warning light to appear ➔ 146.



### Indicator light ESC OFF

This warning light comes ON, when the ignition is ON and goes after few seconds ➔ 147.



### Warning light to indicate a fault or unavailability of « Active emergency braking » function ➔ 158



### Warning light of the « Active emergency braking » function ➔ 158



### ECO mode function

It lights up when Eco mode is engaged ➔ 136



### Brake circuit fault warning light

It lights up when the ignition or the engine is switched on and goes off after a few seconds.

If it comes on during braking and is ac-

light and a beep, it indicates that the fluid level in the circuit is low or that there is a braking system fault. Stop as soon as traffic conditions allow and consult an approved dealer.



### Hand brake applied ➔ 132



### Variable power assisted steering warning light

It lights up when the ignition or the engine is switched on and goes off after a few seconds.

Depending on the vehicle, it lights up in the event of a battery fault ➔ 118. If it comes on while driving, alongside

the warning light **STOP**, this means there is a system fault. Call an approved dealer.



### Anti-lock wheel light

It lights contact set and turns off within about three seconds. If it lights up while driving, it signals a failure of the anti-lock wheel system. Braking is then provided normally but without anti-lock wheels. contact an approved dealer.



### Foot indicator on brake pedal

It lights up when a brake pedal is pressed.

companied by the **STOP** warning

## WARNING LIGHTS

2



**Lane departure prevention system warning light** → 150



**Driver vigilance warning function fault warning light** → 166



**Overspeed warning light**

A beep will sound and the warning light will come on if the vehicle exceeds 75 mph (120 km/h).



**Battery charge indicator**



**Electrotechnical system temperature indicator**

It lights up along with the warning light

**STOP** and a beep when the electrical assembly temperature is too high. Stop the vehicle and switch off the ignition. Consult an approved dealer.  
**If it lights up accompanied by the**

**warning light STOP**, a beep and the « **EVACUATE IN SAFETY** » message, switch off the ignition and do not restart the engine. Leave the vehicle and consult an approved dealer.



The « **EVACUATE IN SAFETY** » message accompanied by the warn-

ing light **STOP** and a beep requires that you stop the vehicle immediately, depending on the traffic conditions. Switch off the ignition. Leave it switched off. Exit the vehicle, get all passengers out of the vehicle and keep them away from the vehicle and traffic.

**Fire hazards**



If the vehicle is parked on the hard shoulder, you must warn other road users of your vehicle's presence with a warning triangle or with other devices as per the legislation applying to the country you are in.



**Electrotechnical Major failure indicator**

When it lights up, it signals an electrotechnical defect related to the elec-

tric group (traction battery and electric motor). contact an approved dealer.



**Electrotechnical failure indicator**

When it lights up, it signals an electrical fault related to the electric motor. Quickly contact an approved dealer.



If no lights or sounds are apparent, this indicates a fault in the instrument panel. This indicates that it is essential to stop immediately (as soon as traffic conditions allow). Ensure that the vehicle is correctly immobilised and contact an approved dealer. Failure to follow these recommendations may cause damage to the vehicle for which driver shall be responsible.

## WARNING LIGHTS

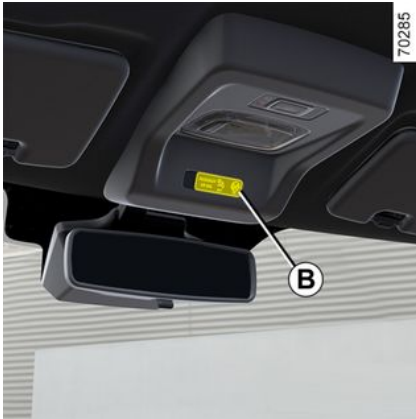

On display *B*



**Airbag Passenger ON**



**Airbag passenger OFF**

# STEERING

## Adjusting the steering wheel

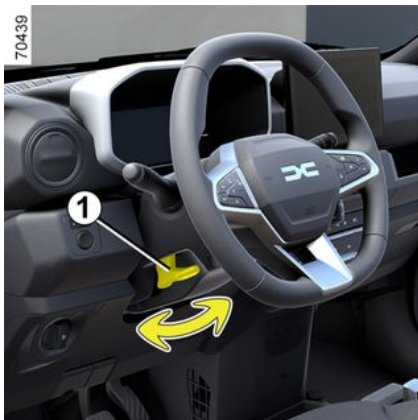

Depending on the vehicle, the steering wheel height are adjustable.

Push the lever **1** downwards and set the steering wheel to the desired position, then raise the lever to lock the steering wheel.

Make sure that the steering wheel is correctly locked.

### Power-assisted steering

Never drive with an inadequately charged 12V battery.

### Variable power assisted steering

The variable power-assisted steering system is equipped with an electronic

control system which alters the level of assistance to suit the vehicle speed.

Steering is made easier during parking manoeuvres (for added comfort) while the force needed to steer increases progressively as the speed rises (for enhanced safety at high speeds).

### Special case

Depending on the vehicle, in the event of a battery fault (disconnected, discharged battery, etc.), a reset of the steering wheel angle must be carried out. To do this:

- the vehicle stationary and on flat ground;
- with the driver alone in the vehicle,

start the engine: the  warning light and/or, depending on the vehicle, the « Turn steering wheel fully right and left » message are/is displayed on the instrument panel;

- turn the steering wheel fully to the left, then to the right by exerting pressure upon arrival at the stop. Turn off the ignition and wait about one minute. At the next engine starts, the indicator and/or, depending on the vehicle, the message will switch off.



Never leave the steering wheel on full lock when the vehicle is stationary.



Never switch off the ignition when travelling downhill, and avoid doing so in normal driving (power steering and brake servo will not function).



With the engine switched off, or if there is a system fault, it is still possible to turn the steering wheel. The force required will be greater.

## REAR VIEW

### Foldable door mirrors

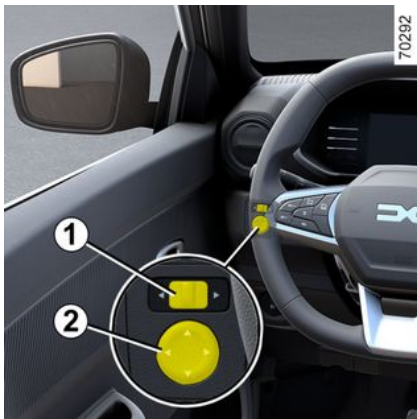

The door mirrors can be folded : simply fold them manually against the door window.

### Door mirror with electrical adjustment

With ignition ON, slide the switch **1** to select the door mirror, then use the control **2** to adjust it to the desired position.

### Manual adjustment



Adjust the door mirror according to rear vision by adjusting the knob **3**



Objects observed in the door mirror glass are actually closer than they appear. For your safety, take this into account in order to correctly assess the distance before any manoeuvre.

### Interior rear view mirror 4

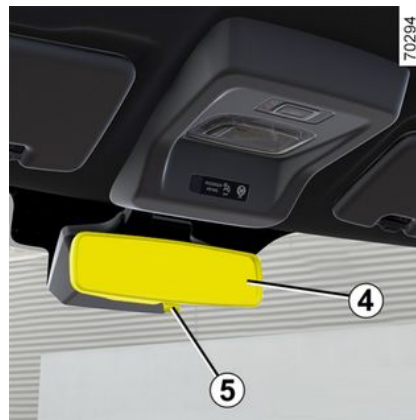

The interior rear-view mirror **4** is manually adjustable. When driving at night, tilt the mirror by lever **5** or by hand to avoid being dazzled by the headlights of the vehicle behind.



For safety reasons, carry out any adjustments when the vehicle is not being driven.

# LIGHTING AND SIGNALS

## Exterior lighting and signals

### Daytime running lights function



If fitted on the vehicle, the daytime running lights come on automatically with no action on stalk **1** when the engine is started, and they go off once the engine is switched off.

**Note:** daytime running light will go out automatically when the indicator is in operation.

### Side Lights

 Turn the ring **1** until the symbol is opposite mark **2**.

This indicator light on the instrument panel comes on.

**NOTE:** Depending on the vehicle, manual activation of the position lights is only possible when the parking brake is applied. Otherwise, the message « Parking lights unavailable » is displayed on the dashboard to warn you that activation of the parking lights is not possible.

### Dipped beam headlights

#### Manual operation

Turn ring **1** until the symbol is opposite mark **2**. This indicator light on the instrument panel comes on.

#### Automatic operation

(depending on vehicle)

Turn the ring **1** until the **AUTO** symbol is opposite mark **2** with the engine running, the dipped beam headlights switch on or off automatically depending on the brightness of the light outside, without any action and stalk **1**.

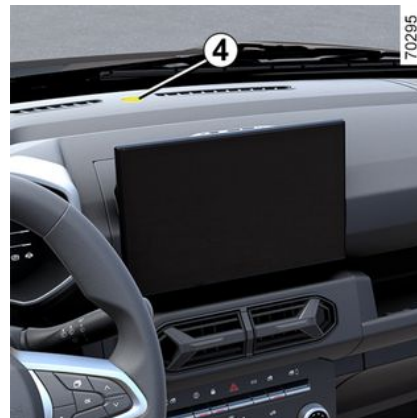

 When driving on the left in a left-hand drive vehicle (or vice versa), drivers must have the lights adjusted by an authorised dealer for the duration of the trip.

 Always make sure that :

- the windscreen is not obscured (dirt, mud, snow, condensation etc.) ;
- the light sensor **4** is not obscured (by dirt, objects etc.).

# LIGHTING AND SIGNALS

## Main beam headlights

 With the engine running and the dipped beam headlights on, push stalk **1**. This indicator light on the instrument panel comes on.

To return to the dipped headlight position, pull stalk **1** towards you.

## Rear fog light

 Turn the central ring **3** on the stalk until the symbol faces mark **2** then release it.

Operation of the fog lights depends on the exterior lighting selected, and an indicator light will light up on the instrument panel.

The corresponding indicator light goes out on instrument panel when the fog lights are switched off or the exterior lights are switched off.

To avoid inconveniencing other road users, remember to switch off the rear fog light when it is no longer needed.

## Switching off the lights

Turn the end of stalk **1** until the symbol is opposite mark **2**.

 When driving in fog or snow, or when transporting objects which are higher than the roof, the headlights do not come on automatically. Switching on the fog lights remains the responsibility of the driver : the indicator lights on the instrument panel inform you whether the fog lights are lit (indicator light on) or not (indicator light not on).

 Before driving at night, check that the electrical equipment is operating correctly and adjust the headlight beams (if your vehicle is not carrying its normal load → **246**). As a general precaution, check that the lights are not obscured (by dirt, mud, snow or objects being transported).

## Headlamp beam adjustment



### Headlamp beam adjustment :

Control **A** is used to adjust height of the headlamp beam according to load.

Turn control **A** anticlockwise to lower the beams and clockwise to raise them.

 When driving on the left in a left hand drive (or vice versa), you must adjust your lights temporarily during your stay.

# LIGHTING AND SIGNALS

Table of adjustment position examples

	Examples of positions for adjusting control <b>A</b> according to the load	
	Passenger vehicle	Utility vehicle
<b>Only driver</b>	0	0
<b>Driver with front passenger</b>	1	-
<b>All seats occupied</b>	1	-
<b>Driver with passengers and luggage (or load) reaching the maximum permissible all-up weight</b>	2	-
<b>Driver without passengers and luggage (or load) reaching the maximum permissible all-up weight</b>	3	3

Depending on the version.  
The above table gives some examples. In all cases, adjust control **A** according to the vehicle so that the road can be seen and other drivers are not dazzled.

# LIGHTING AND SIGNALS

## Temporary adjustment

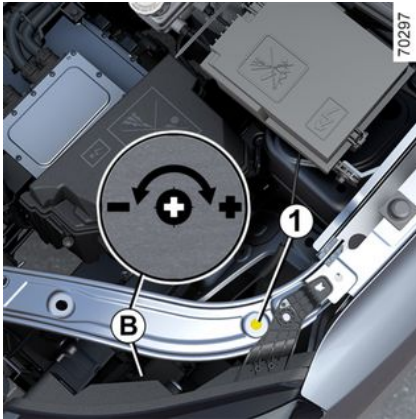

Open the bonnet and identify the marking **B** next to one of the front headlight projectors.

For each headlight, use a screwdriver to turn the screw **1** a quarter of a turn towards the « - » symbol to lower the beams.

Return to the original position once your trip is over: turn the screw **1** a quarter of a turn towards the « + » symbol to raise the beams.

# AUDIBLE AND VISUAL SIGNALS

## Horn



Press the steering wheel boss **A** to activate the horn.

## Head light flasher

Pull stalk **1** towards you then release it to flash the headlights.

## Vehicle sound for pedestrians

Electric vehicles are particularly quiet. This system enables you to warn people of your presence – especially pedestrians and cyclists.

The system is activated automatically when the engine is started. The sound

triggers when the vehicle speed is between 1 and 20 mph (1 and 30 km/h).

### System Activated :

- it goes on standby automatically when the vehicle speed is above approximately 20 mph (30 km/h) ;
- the system is activated automatically when the vehicle is being driven at a speed below 20 mph (30 km/h).approximately.

## Direction indicators

Move stalk **1** parallel to the steering wheel and in the direction you are going to turn it.

When driving on motorway, the steering is not usually turned sufficiently to enable the stalk to return automatically to home position. There is intermediate position where the stalk will not be held for lane change indication and there will be 3 blinks of indicator lights in dedicated direction.

If it does not return back automatically, release the stalk manually and it will return to its home position.

## Hazard warning lights



 Press switch **2**.

This switch activates all four direction indicators and the side indicator lights simultaneously.

It must only be used in an emergency to warn drivers of other vehicles that you have had to stop in an area where stopping is prohibited or unexpected, or that you are obliged to drive under special conditions.

# WIPERS

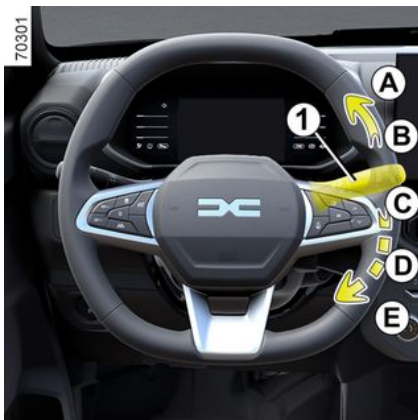

## Front Windscreen wiper

 With the ignition on, move stalk **1** around the steering wheel (depending on vehicle) :

**A** One time Mist removal function.

**B** Park.

**C** Intermittent wiping (depending on the vehicle) - The wipers will pause for several seconds between sweeps.

**D** Continuous slow wipe.

**E** Continuous fast wipe.

## Front Windscreen washer

 With the ignition on, pull stalk **1** towards you (depending on the vehicle).

A brief pull will trigger a single sweep of the wipers, in addition to the windscreen washer.

A longer pull will trigger multiple sweeps of the wipers, in addition to the windscreen washer, until stalk **1** is released. When the stalk is released, the wipers will complete three additional sweeps followed, a few seconds later, by a fourth.

If you switch off the ignition before switching off the windscreen wiper (position **B**) the blades will stop at random on the windscreen. After switching the ignition back on, simply move stalk **1** to position **B** to place the windscreen wipers in the park position.



When working in the engine compartment, ensure that the windscreen wiper stalk is in position

**B** (park).

**Risk of injury.**



## Efficiency of a wiper blade

Check the condition of the wiper blades. How long they last depends on you :

- it must remain clean : clean the blade and the screen regularly with soapy water ; ;
- do not use it when the screen is dry ;
- free it from the screen when it has not been used for a long time.

In all cases, replace it as soon as it begins to lose efficiency : approximately once a year → **235**  
**Precaution for using the wipers**

- In freezing or snowy weather conditions, clear the screen before starting the wipers (risk of wiper motor overheating);
- ensure that no objects are obstructing the travel of the blade.

## WIPERS

### Rear screen wiper

2

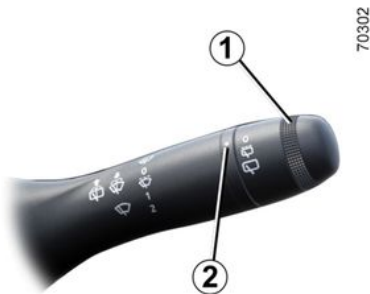

70302

When released, it returns to the rear screen wiper position.



Before any action involving the windscreen (washing the vehicle, de-icing, cleaning the windscreen, etc.) return stalk 1 to position **B** (park).

**Risk of injury and/or damage.**



Do not use the wiper arm to open or close the tailgate.



Do not try to lift the wiper blades. They cannot remain detached from the windscreen. To replace the blades, → 235



Before using the rear wiper, check that no object is obstructing the travel of the blade.

In frosty weather, make sure that the wiper blade is not stuck by ice (risk of motor overheating).

Keep an eye on the condition of the blades. They should be replaced as soon as they become less efficient.

Regularly clean your rear windscreen.



With the ignition on, turn the end of stalk 1 to align the symbol with mark 2.

#### Special feature

The rear screen is wiped once if reverse gear is selected when the windscreen wipers are in operation or have been turned off within the previous two minutes → 235.

### Rear screen washer



With the ignition on, turn the end of stalk 1 to align the symbol with mark 2.

# STARTING, STOPPING THE ENGINE

## Stop and steering lock position **St**



To lock : remove the key and turn the steering wheel until the steering column locks.

To unlock : turn the key and the steering wheel slightly.

## Accessories position **A**

When the ignition is switched off, any accessories (radio, etc.) will continue to function.

## Ignition ON position **M**

The ignition is switched on :  
– the engine may be started.

## Ignition ON position **D**

Turn the key to position **D** and then release it.



Never switch off the ignition before the vehicle has come to a complete stop. Switching off the engine disables the assistance equipment : brakes, power-assisted steering, etc., and the passive safety devices such as airbags and pretensioners.

## Stopping the engine

With the engine running, turn the key back to the « Stop » position **St**. The engine gets switched off.



Before starting the vehicle, perform the below steps.

- Drive mode in **N** condition ;
- Press brake pedal  ;
- Turn the key to position **D** and release it;
- warning indicator « **READY** » will appear in the cluster.

## Special note

Depending on the vehicle, accessories (e.g. radio) stop working either when the engine is switched off or when the doors are locked.

## Starting problems

To avoid damage , do not keep trying to start the engine (by pushing or towing the vehicle) **without having identified and corrected the cause of the fault.**

If the fault cannot be identified, do not continue to try and start the engine, but contact an approved dealer.



The vehicle can only be started if the charging cord is unplugged from the vehicle.

## STARTING, STOPPING THE ENGINE



Driver's responsibility  
when parking or stop-  
ping the vehicle

Never leave an animal,  
child or adult who is not self-suffi-  
cient alone in your vehicle, even  
for a short time.

They may pose a risk to them-  
selves or to others by starting the  
engine, activating equipment such  
as the electric windows or locking  
the doors, for example.

Also, in hot and/or sunny weather,  
please remember that the temper-  
ature inside the passenger com-  
partment increases very quickly.

**RISK OF DEATH OR SERIOUS  
INJURY.**

# GEAR CONTROL

## Electronic selector lever 1



**R:** Reverse mode.

**N:** Neutral.

**D:** Automatic mode.

**B:** Forward gear with increased regenerative braking.



The **2** display on the instrument panel indicates the gear lever position engaged **1**.

## Operation

Shift the selector lever **1** one or two notches forwards or backwards to the desired position (**R**, **N**, **D** or **B**) then release the lever and it will return to the stable position.

The position engaged is displayed on the instrument panel.

If certain conditions prevent shifting from one position to another, the current position flashes on the instrument panel.



### NOTE:

Always press the brake pedal and select the drive mode. If the brake is not pressed,

the indicator  comes on the instrument panel warns to press the brake pedal before selecting any (**R/N/D/B**) mode.

## To engage neutral

With the vehicle stopped and the engine on, to select **N** position, move the **1** selector lever one notch forwards or backwards according to the gear engaged.

## Driving in automatic mode

With the vehicle stationary and the engine on, move the selector lever **1** two notches backwards to engage position **D**.

If one of the conditions is not applied, **D** flashes for around 5 seconds and the message « Apply brake » is displayed on the instrument panel for approximately 15 seconds.

In the majority of driving conditions, you will no longer have to use your gear lever: the gears change « automatically », at the right time, to a suitable engine speed because the auto-

## GEAR CONTROL

mated system takes the vehicle's load, road profile and the selected driving style into account.

**i** with the engine running and the vehicle travelling at between 0 and 5 mph (0 and 8 km/h), in position **N** or **R**, it is necessary to depress the brake pedal to engage position **D**. This is useful during parking manoeuvres requiring a number of alternate forward and reverse movements.

### Driving in mode B

This mode enables driving with greater regenerative engine braking.

When releasing the accelerator pedal, the vehicle uses regenerative braking to slow down. Thus the electric motor generates a higher electrical current which enables the traction battery to be recharged.

In **B** mode, the regenerative braking will be reduced if the accumulator is cold or completely charged.



The engine brake should under no circumstances be used as a substitute for the brake pedal.

### To select reverse gear

With the vehicle stationary and the engine on, move the selector lever **1** two notches forwards to engage position **R**.

If the brake pedal is not depressed, a beep will sound, the display of position **R** flashes for around 5 seconds in the grid shown on the instrument panel, and a message « Press brake » is displayed for around 15 seconds.



with the engine running and the vehicle moving at between approximately 0 and 5 mph (8 km/h) position **N**, or **D**, you need not press the brake pedal in order to engage **R**. This is useful during parking manoeuvres requiring a number of alternate forward and reverse movements.

## Parking the vehicle

When the vehicle is stationary, stop the engine. Neutral position « **N** » is engaged while keeping your foot on the brake pedal.

**Ensure that the handbrake is engaged and make sure the vehicle is immobilised.**

**NOTE:** vehicle stationary, position **N** engaged, brake pedal not pressed, if the message « Risk of gearbox breakage » appears on the dashboard: check that the gear lever is not held in position **D/B** or **R** then turn off the ignition.

The next time the engine is started, the warning light turns off. If this is not the case, it may be due to another cause, consult an approved Dealer.

### Operating faults

#### During driving:

- if the message « WARNING: Check Gearbox » appears on the instrument panel, this indicates a fault. Contact your approved Dealer as soon as possible;
- if the message « WARNING: Gearbox Overheating » appears on the instrument panel, stop as soon as possible to allow the gearbox to cool down and wait for the message to disappear.

## GEAR CONTROL



The **N** position of the gear selector does not mechanically lock the drive wheels, make sure it is immobilised before leaving the vehicle.



When the door is opened, the message « Select NEUTRAL N » is displayed on the instrument panel if the gear control is in a position other than **N** and the engine is not switched off.



In the event of an impact to the underside of the vehicle (e.g.: striking a post, raised kerb or other street furniture), this may result in damage to the vehicle (e.g.: twisted axle), the electrical circuit or the traction battery.

Do not touch the circuit elements or any fluids or liquids.

To prevent any risk of accident, have your vehicle checked by an authorised dealer.

**Risk of serious injury or electric shock and risk to life.**



In the event of an engine fault or an electrical fault (battery fault, etc.), make sure that the vehicle is properly immobilised.



In the event an impact to the underside of the vehicle (e.g.: striking a post, raised kerb or other street furniture) this may result in damage to the vehicle (e.g.: twisted axle), the electrical circuit or the traction battery.

Do not touch the circuit elements or any fluids or liquids.

To prevent any risk of accident, have your vehicle checked by an authorised dealer.

**Risk of serious injury or electric shock and risk to life.**

## HANDBRAKE



### To release

Pull the lever **3** upwards slightly, press button **2** and lower the lever to the floor.

The warning light  on the instrument panel will go out.

The red warning light will light up on the instrument panel, accompanied by a beep along with the message « Parking Brake ON », if you are driving with an incorrectly released handbrake at speeds over 12 mph (20 km/h).

### To apply

Pull lever **3** upwards and make sure the vehicle is immobilised. The warn-

ing light  on the instrument panel will come on.

## Sloped Parking

When parking on a slope, depending on the slope and/or vehicle load, it may be necessary to pull up the handbrake at least two extra notches.



When parking on a slope, in road conditions such as mud, sand, snow or ice, movement of the vehicle may be possible. Steer the wheel so that the vehicle comes to rest against a robust element (pavement etc.).



Make sure that the handbrake is properly released when driving (red indicator light off), otherwise overheating, or even damage, may occur.



Make sure that the handbrake is applied always whenever the vehicle is in charging condition.



In the event an impact to the underside of the vehicle (e.g. : striking a post, raised kerb or other street furniture) this may result in damage to the vehicle (e.g. : twisted axle), the electrical circuit or the traction battery. Do not touch the circuit elements or any fluids or liquids. To prevent any risk of accident, have your vehicle checked by an authorised dealer.  
**Risk of serious injury or electric shock and risk to life.**

## ENVIRONMENT

Your vehicle has been designed with respect for the **environment** in mind for its entire service life: during its production, usage and at the end of its service life.

### Manufacture

Your vehicle has been manufactured at a factory which complies with a policy to reduce the environmental impact on the surrounding areas (reduction of water and energy consumption, visual and noise pollution, atmospheric emissions and waste water; sorting and reusing waste).

### Please make your own contribution towards protecting the environment too

– Parts and vehicles at the end of their life must not be thrown away. They must be handed to a legal entity that complies with environmental standards.

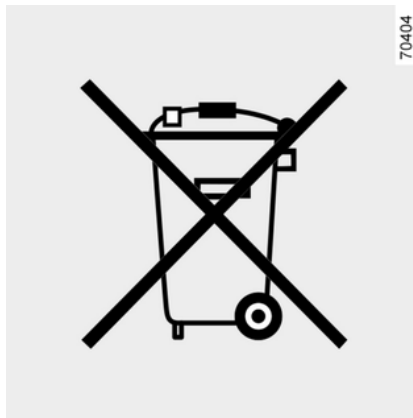

– Worn parts and components that are replaced during routine vehicle maintenance, such as tyres, must be disposed of at dedicated collection points.

– Worn **electrical and electronic** components that are replaced (such as batteries, etc.) must not be thrown away as rubbish. Take them to an approved Dealer or consult your local authority for information on appropriate recycling facilities.

– To optimise the recycling of your vehicle at the end of its life, you can contact an authorised dealer or visit the manufacturer's website to be directed to collection points that guarantee respect for the environment complying with local laws.

### Recycling

Your vehicle is at least 85% recyclable and at least 95% recoverable.

To achieve these objectives, many of the vehicle components have been designed to enable them to be recycled.

The materials and structures have been carefully designed to:

- allow these components to be easily removed and reprocessed by specialist companies;
- promote a circular economy (re-use, recycling, recovery, etc.)

This is particularly true for electrified vehicle batteries.

In order to preserve raw material resources, your vehicle also includes many parts made from recycled plastics or renewable materials.

## DRIVING ADVICE, ECO-DRIVING

Range is accredited in according to a standard regulatory method. Identical for all manufacturers, this enables vehicles to be compared with one another.

3

Range in real time depends on vehicle usage conditions, equipment fitted and the user's driving style. To optimise range, please refer to the following advice.

Depending on the versions, you will be provided with functions which enable you to lower energy consumption:

- on the instrument panel:
  - the econometer;
  - the driving style indicator;
  - the acceleration indicator Eco.
- on the multimedia screen:
  - data relating to your energy consumption;
  - an energy consumption graph;
  - scores based on your driving style;
  - Eco driving advice;
  - an ECO driving mode.

### On the instrument panel A

Depending on the vehicle, the information display can be organised and customised based on the instrument panel customisation style selected from the multimedia screen.

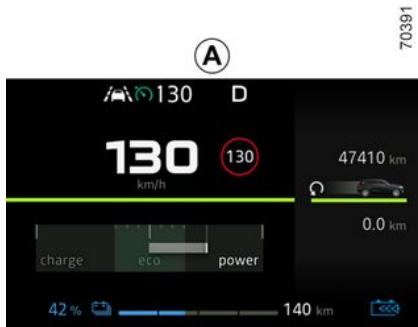

70391

### Econometer

(on the instrument panel)

The econometer gives the driver a real-time view of the vehicle's energy recovery or consumption.

#### « Energy recovery » A usage zone

When driving, if you lift your foot off the accelerator pedal or press the brake pedal, the motor generates electrical current during deceleration, and this energy is used to slow down the vehicle and recharge the traction battery

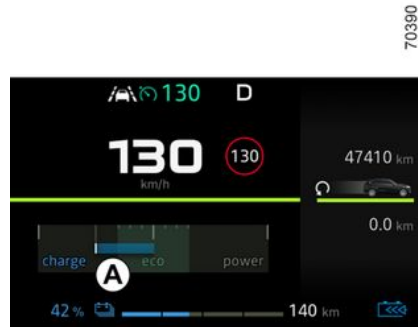

70390

« Optimal » 0 usage zone  
(depending on vehicle)

Indicates nil consumption.

« Consumption recommended » usage zone B

# DRIVING ADVICE, ECO-DRIVING

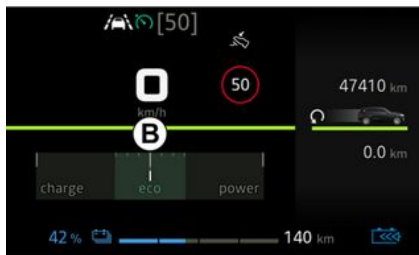

The traction battery supplies the electrical energy required for the motor to move the vehicle.

« **Consumption not recommended** » usage zone **C**

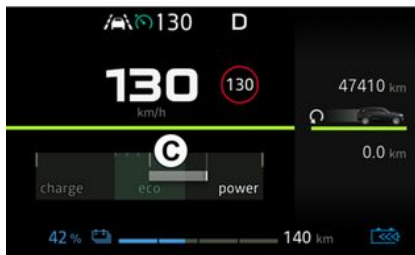

Indicates high energy consumption.

 The presence and display of this information depends on the ambient setting selected.

## Driving style indicator 1



3

After activation, you will be informed about the driving style adopted in real time. You will be notified by indicator **1**.

The more petals displayed on the indicator **1**, the more your driving is flexible and economical.

If you regularly monitor this indicator, you will reduce your vehicle's \*energy consumption.

Please refer to the multimedia instructions for further information.

## DRIVING ADVICE, ECO-DRIVING

### Acceleration indicator Eco 2

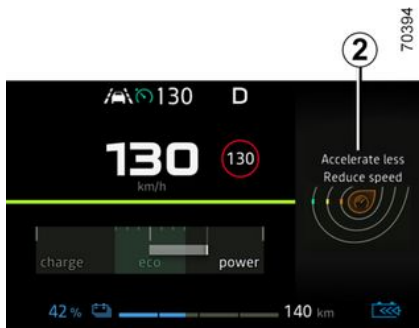

Depending on the vehicle, this informs you in real time whether you are accelerating moderately or strongly.

You will be notified by indicator **2**:

- green: acceleration is moderate and correct;
- white: acceleration is too high;
- grey: acceleration is high.

**Note:** it is not possible to simultaneously display the driving style indicator **1** and the Eco acceleration indicator **2**.

### On the multimedia screen 3



### Journey record

On equipped vehicles, once the engine is switched off, a « Journey record » is displayed on the multimedia screen **3**. This log shows the information relating to your last journey:

- your average energy consumption;
- the number of miles/kilometres travelled;
- an overall grade taking into account acceleration, braking anticipation and your skill in managing speed;
- advice to enable you to improve your rating.

An overall rating from 0 to 100 is displayed to let you assess your eco driving performance.

The higher the rating, the lower the energy consumption.

Eco advice is given to help improve your performance.

Please refer to the multimedia instructions for further information.

### Eco mode function

The ECO function optimises vehicle range by limiting engine performance and maximum speed (limited to approximately 62 mph (100 km/h). It acts upon some consumer systems in the vehicle (power-assisted steering etc.) and on certain driving actions (acceleration, deceleration etc.).

# DRIVING ADVICE, ECO-DRIVING

## Activating the function



Press switch **4**

Warning light **5** will come on the instrument panel and the integrated warning light on the switch will light up.

While driving, it is possible to exit the ECO mode temporarily in order to improve engine performance.

To do this, press the accelerator pedal firmly and fully.

ECO mode is reactivated when you take pressure off the accelerator pedal.

## De-activating the function



Press switch **4**.

Warning light **5** goes out on the instrument panel.

## Vehicle range

### Advice

In real usage, the range of an electric vehicle may vary depending on several factors over which you have partial control, which may make a considerable difference to the vehicle range.

These factors are:

- speed and driving style;
- road type;
- heating level;

- tyres;
- use of electrical accessories;
- vehicle loading.

Furthermore, activating mode ECO enables the vehicle to automatically take charge of all energy consumers (engine power etc.) to reduce their consumption to the fullest possible extent → **136**.

## Speed and driving style

56721



Driving at high speed will significantly reduce your vehicle's range.

Examples (at a steady speed):

- reducing the speed from approximately 80 mph (130 km/h) to 68 mph (110 km/h) allows you to save up to around 20% of fuel range;

## DRIVING ADVICE, ECO-DRIVING

– reducing your speed from approximately 56 mph (90 km/h) to 50 mph (80 km/h) allows you to save up to around 10% of fuel range.

« Sporty » driving reduces your vehicle's range: opt for a « smoother » driving style.

### Advice :

- drive at a constant speed ;
- keep an eye on the tools available to you to view the road conditions (charge meter, current consumption, journey record, etc.) ➔ 136;
- adapt your driving style to avoid excessive energy consumption;
- favour energy recovery: anticipate traffic changes by taking your foot off the accelerator pedal or braking gradually.

### Road type



70313

Do not try to maintain the same speed up a hill; accelerate no more than you would on the level. Keep your foot in the same position on the accelerator pedal.

### Heating levels

62429

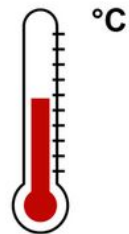

The use of heating or air conditioning reduces vehicle range.

To maintain your vehicle range, we recommend that you select the « Programmable Heating & Air-Conditioning » mode before using the vehicle ➔ 194.

# DRIVING ADVICE, ECO-DRIVING

## Tyres

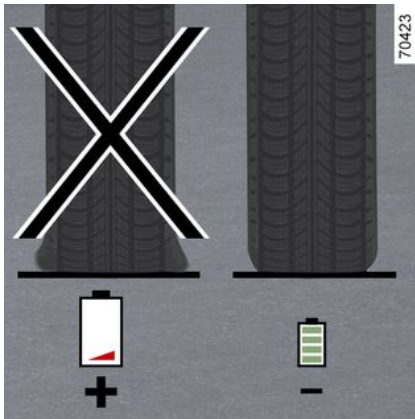

An under-inflated tyre increases energy consumption. Comply with the specified tyre pressures for your vehicle.

When driving, use tyres made by the same manufacturer, with the same dimensions, type and structure as the original tyres. The use of non-regulation tyres significantly reduces vehicle range → 222.

## Vehicle loading

Avoid pointlessly overloading your vehicle.

# TYRE PRESSURE LOSS WARNING

70421

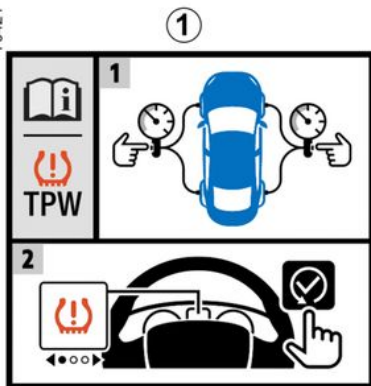

3

When fitted to the vehicle, this system notifies the driver if one or more tyres lose pressure.

The system can be identified by the **1** label in the vehicle.



70307

## Operating principle

This system detects a loss of pressure in one of the tyres by measuring the wheel speed while driving.

Warning light  **2** appears continuously to warn the driver in the event of insufficient pressure (deflated wheel, punctured tyre, etc.).

70395



This function is an additional driving aid. The function does not take the place of the driver. It cannot, therefore, under any circumstances replace the vigilance or the responsibility of the driver. Check the tyre pressures, including the emergency spare wheel, once a month.

## Operating conditions

The system should be reset with a tyre pressure equal to that shown on the tyre pressure label → **222**. Otherwise it

## TYRE PRESSURE LOSS WARNING

may not give a reliable warning in the event of a significant pressure loss.

**Resetting should always be carried out after checking the tyre pressure of all four tyres when cold.**

In the following situations, the system risk coming into action late or not functioning correctly.

- System not reset after reinflation or any operation on the wheels;
- system badly reset different inflation pressure from the recommended pressures;
- significant change in load or distribution of load on one side of the vehicle;
- sporty driving with strong acceleration;
- driving on snowy or slippery surface;
- driving with snow chains;
- fitting a single new tyre;
- use of tyres not approved by the network.

**i** Tyre pressure must be checked before starting the resetting procedure. The system will not issue a warning if the pressure does not correspond to the recommended pressure.

**i** The sudden loss of pressure in a tyre (burst tyre, etc.) cannot be immediately detected by the system.

### Procedure for resetting the standard levels for the tyre pressures

This should be performed:

- after each re-inflation or resetting of tyre pressure;
- after changing a wheel;
- after using the tyre inflation kit;
- after changing wheels around.

It should always be done after checking the tyre pressure of all four tyres when cold.

Tyre pressures must correspond to the current usage of the vehicle (empty, carrying a load, motorway driving, etc.).

Respect the tyre pressures (including the emergency spare wheel). Check them at least once a month and before a long journey (refer to the label on the edge of the driver's door) ➔ 220.



### Vehicle not fitted with a multimedia screen

Ignition on, **vehicle stationary**;

- press button **3** briefly several times to reach the « vehicle » tab;
- briefly press the **4** or **5** switch to reach the « Tyre pressure init. long press » page;
- press and hold the **6** « OK » switch to launch the reset.

Hold down the **6** switch until the « Operation completed » message appears. You can now drive.

### Vehicles fitted with a multimedia screen

The resetting procedure must be carried out while the **vehicle is stationary** and the ignition is switched on.

## TYRE PRESSURE LOSS WARNING

Please refer to the multimedia instructions for further information.

3

# TYRE PRESSURE LOSS WARNING

## Message display

The table below shows the possible messages related to the tyre resetting procedure.

Steps	Messages	Readings
-	Tyre pressure init. at stop	The message is displayed during driving. If you want to reset the pressure of the four tyres, stop the vehicle.
1	Tyre pressure init. long press	To reset the pressure of the four tyres, with the vehicle stopped, press and hold the <b>6</b> « OK » switch to launch resetting until the «If pressure OK [hold on] » message is displayed.
2	If pressure OK [hold on]	The message flashes, reminding you that the pressure must be adjusted to the values recommended on the tyre → <b>222</b> inflation pressure label before resetting the system. Press and hold switch <b>6</b> « OK » to confirm the reset request until the message « Operation completed » appears.
3	Operation completed	The resetting procedure has been completed successfully. You can now drive.

# TYRE PRESSURE LOSS WARNING

## Readjustment of tyre pressures

The tyre pressures of the four tyres must be set when cold (refer to label **A** located on the edge of the driver's door) → 222.

If tyre pressures cannot be checked when the tyres are cold, the recommended pressures should be increased by 0.2 to 0.3 bar (3 PSI).

**Never deflate a hot tyre.**

After each reinflation or readjustment of the tyre pressure, launch the reinitialisation of the tyre pressure reference value.

## Replacing wheels/tyres

Only use equipment approved by the brand network.

otherwise the system risks late activation or incorrect operation → 220.

After each change of wheel/tyre, readjust the tyre pressure and launch the reset of tyre pressure reference value.

## Emergency spare wheel

If fitted on the vehicle, readjust the tyre pressure and launch the resetting of the tyre pressure reference value.

## Tyre repair product and inflation kit

Only use equipment approved by the brand network, otherwise the system

risks late activation or incorrect operation. → 224.

After using the tyre inflation kit, readjust the tyre pressure and launch the resetting of the tyre pressure reference value.

## Tyre pressure faults







The following table lists the warning messages that appear on the instrument panel 7 when the system detects a tyre pressure fault.

# TYRE PRESSURE LOSS WARNING

## Fault message table

The information on the instrument panel signals any potential tyre pressure faults (e.g. deflated or punctured tyre).

Indicator lights	Messages	Readings
 comes on	Inflate tyres and init.	This indicates that tyre under-inflation or puncture has been detected. Check and adjust the pressure of the four tyres when cold and reset the system.
 flashes, then stays on	Check tyre press and init.	This indicates that the reset has been unsuccessful. Check and readjust the tyre pressure before re-launching the resetting procedure.
 flashes, then stays on, along with the warning light 	Check TPW	This indicates a fault in the system. Consult an approved dealer.
 flashes, then stays on	TPW not available	This indicates that an emergency spare wheel different in size to the other four wheels has been fitted to the vehicle. The system remains unavailable until a wheel identical in size to the other wheels has been fitted and the resetting procedure has been carried out.

## DRIVER CORRECTION AND ASSISTANCE DEVICES

Your vehicle is fitted with:

- **ABS (anti-lock braking system);**
- **electronic stability program ESC with understeer control and traction control;**
- **emergency braking assistance;**
- **hill start assist.**



These functions are an additional aid in the event of critical driving conditions, enabling the vehicle behaviour to be adapted to suit the driving conditions. However, these functions cannot replace the driver. **They do not increase the vehicle's limits and should not encourage you to drive more quickly.** Therefore, they can under no circumstances replace the vigilance or responsibility of the driver when manoeuvring the vehicle (the driver must always be ready for sudden incidents which may occur when driving).

### ABS (anti-lock braking system)

Under heavy braking, the ABS avoids the wheels from locking up, optimising

the braking distance, while maintaining control over the vehicle. Under these conditions, it is possible to avoid obstacles, including while braking. In addition, this system can optimise stopping distances, particularly on roads with low surface grip (wet ground etc.).

Each activation of this function can be felt through a tremor in the brake pedal. The ABS does not in any way improve the vehicle's physical performance relating to the road surface and roadholding. It is still **essential** to follow the rules of good driving practice (such as driving at a safe distance from the vehicle in front etc.).



In an emergency, it is recommended to apply **firm and continuous pressure** to the brake pedal. There is no need to pump it repeatedly. The ABS will modulate the force applied in the braking system.

### Operating faults

- If the  warning light on the instrument panel comes on while driving, **brakes will still work normally without ABS ;**

- If the  and  warning lights on the instrument panel come on when driving, **this indicates a fault with the braking system.**

In this case, ABS is also deactivated. Consult an approved dealer.

### Electronic stability program ESC with understeer control and traction control

#### Electronic Stability Program ESC (depending on the vehicle)

This system helps you to keep control of the vehicle in critical driving conditions (avoiding an obstacle, loss of grip on a bend, etc.).

#### Understeer control

This system optimises the action of the ESC in the case of pronounced understeering (loss of front axle road holding).

#### Traction control

This system helps to limit wheelspin of the drive wheels and to control the vehicle when pulling away accelerating or decelerating.

# DRIVER CORRECTION AND ASSISTANCE DEVICES

## Deactivating the ESC function



Ignition on, **vehicle stopped**;

In some situations (driving on very wet ground: snow, mud, etc. or driving with snow chains fitted), the system may reduce the engine output to limit wheelspin.

If this is not required, it is possible to deactivate the function:

- press button **1** briefly several times

to to reach the  menu;

- repeatedly press control **2** or **3** to

access the «  Vehicle Setting » menu. Press the **OK** switch **4**;

- press control **2** or **3** repeatedly until you reach the « Traction control » menu. Press the **OK** switch **4**;
- press the **OK** switch **4** to deactivate the ESC function.

The warning message « ESC OFF »

and warning light  on the instrument panel comes on to warn you of this.

If you deactivate this function, the traction control system will also be deactivated.

With the Electronic Stability Program ESC with understeer control and traction control providing additional safety, you are advised not to drive with the function disabled.

**Note:** the function is automatically re-activated when the ignition is switched on, or when the speed exceeds 30 mph (50 km/h), below 30 mph (50 km/h), the function is deactivated.

### Operating principle

A sensor in the steering wheel detects the direction selected by the driver.

Other sensors throughout the vehicle measure the actual direction. The system compares driver input to the actual trajectory of the vehicle and corrects the trajectory if necessary by controlling the braking of certain wheels and/or engine power. In the event that the

system is engaged, the indicator light  flashes on the instrument panel.

### Operating faults

When the system detects an operating fault, warning message and the warn-

ing light  appear on the instrument panel.

In this case, the Electronic Stability Program ESC with understeer control and traction control are deactivated.

Please consult an authorised dealer if these warning lights remain displayed on the instrument panel after the ignition is switched off and on again

## Emergency brake assist

This system supplements the ABS and helps reduce vehicle stopping distances.

### Operating principle

The system is for detecting an emergency braking situation. In this case, the braking system immediately develops maximum power and may trigger ABS regulation.

ABS braking is maintained as long as the brake pedal is applied.

### Operating faults

When the system detects an operating fault the message « WARNING: Check

## DRIVER CORRECTION AND ASSISTANCE DEVICES

Braking System » appears on the in-

strument panel along with the warning light.



Consult an approved dealer.

3

### Hill start assistance

This function assists the driver when starting on hills. It prevents the vehicle from rolling forwards or backwards by automatically applying the brakes when the driver lifts their foot off the brake pedal to depress the accelerator pedal.

#### System operation

It only operates when the gear selector is in a position other than neutral (other than **N**) and the vehicle is completely stationary (brake pedal depressed).

The system holds the vehicle for approximately **2 seconds**. The brakes are then gradually released (the vehicle will move according to the slope).



The hill start assistance system cannot completely prevent the vehicle from rolling backwards in

all situations (extremely steep gradients, etc.).

In all cases, the driver may depress the brake pedal to prevent the vehicle from rolling forwards or backwards.

The hill start assistance function should not be used for prolonged stops : use the brake pedal.

This function is not designed to immobilise the vehicle permanently.

If necessary, use the brake pedal to stop the vehicle.

The driver must remain particularly vigilant when driving on slippery or low-grip surfaces and/or on hills.

**Risk of serious injury.**

## ADDITIONAL DRIVING AID FUNCTIONS

### My Safety

The « My Safety » function can be used to deactivate or activate a set of driving assistance functions simultaneously.

Depending on the vehicle, you can configure the « My Safety » function from the multimedia screen or from the instrument panel by selecting the driving aid functions to be switched off as a group.

### Operation



« All on » mode

Depending on the vehicle, this mode includes the following driving assistance functions:

- overspeed sound alert → 168;
- lane departure prevention → 150;
- driver vigilance warning → 166.

When the « All on » mode is activated: the indicator light on the button 1 lights up and the « My Safety ALL ON selected » message is displayed on the instrument panel to confirm this. The driving aids that are available in the mode are activated.

### « Perso » mode

You can use this mode to **deactivate** or **reactivate** some driving aids that are available in the « All ON » mode previously configured using the « My Safety Perso » setting.

Once the ignition is on, **press button 1 twice** in succession to activate the « Perso » mode.

On the first press, the « Press again for My Safety Perso » message is displayed on the instrument panel. On the second press, the indicator light on the button 1 goes out. The « Perso » mode is activated. The message « My Safety Perso selected » is displayed on the instrument panel.

To switch back to « All On » mode, **press once** on the button 1. The indicator light on button 1 lights up.



Depending on the vehicle, depending on the length of time following the last time the engine was stopped, the « All On » mode is reactivated:

- when the vehicle is unlocked;
- or
- when a door is opened;
- or
- when the engine is restarted.

### Configuration of My Safety Perso



For safety reasons, carry out any adjustments while the vehicle is stationary.



The « My Safety Perso » settings saved for the « Perso » mode are stored when the engine was last stopped or when the doors were locked.

## ADDITIONAL DRIVING AID FUNCTIONS

### Configuration from the multimedia screen 2





Refer to the multimedia instructions for information on accessing the settings.

### Configuration from the trip computer



Vehicle stationary:

- press the switch **3** repeatedly to access the  menu;
- repeatedly press control **4** or **5** to

access the «  Vehicle Setting » menu. Press the **OK** switch **6**;

- press control **4** or **5** repeatedly until you reach the « My Safety Perso » menu. Press the **OK** switch **6**;
- select the driving aids to be added or removed from the « Perso » mode by repeatedly pressing the **4** or **5** control. Press the **OK** switch **6** to add or remove driving aids.

### Lane departure prevention

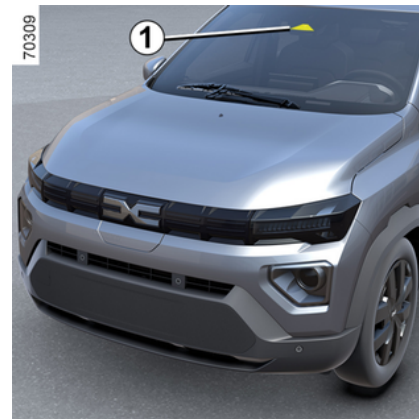

Using information from the **1** camera, the function triggers corrective action on the vehicle steering system when a continuous or dashed line is crossed or when approaching the roadside (divider, barrier, pavement, embankment, etc.) without activating the direction indicator lights.

Depending on the setting, in the event of crossing a dashed line without activating the direction indicator lights, the function:

- warns the driver without corrective action on the steering system;
- or

## ADDITIONAL DRIVING AID FUNCTIONS

– performs corrective action on the steering system.



You can **retake control of the vehicle** at any time by operating the steering wheel.

### Location of the camera 1

Make sure the windscreen is not obscured (by dirt, mud, snow, condensation etc.).



This function is an additional driving aid. This function is not under any circumstances intended to replace the due care and attention of the driver, who should at all times be in control of the vehicle.

### Activation/deactivation



Depending on the vehicle, depending on the time following the last engine shut-down, the function reactivates:

- unlocking the vehicle;
- or
- opening a door;
- or
- at engine restart.

### Activating, deactivating using the switch 2



– **To deactivate the function**, if it has been deactivated from the « Perso » mode of the « My Safety » ➔ **149** function, press switch **2** twice. The warning

light  is displayed in yellow on the instrument panel.

– **To reactivate the function**, press the **2** switch once. Warning light  is displayed in grey on the instrument panel.

### Vehicle equipped with multimedia screen 3



Please refer to the multimedia instructions for further information.

### Vehicle not equipped with multimedia screen

## ADDITIONAL DRIVING AID FUNCTIONS





Vehicle stationary:

- press switch **4** repeatedly to access the  menu;
- repeatedly press control **5** or **6** to

access the «  Vehicle Setting » menu. Press the **OK** switch **7**;

- press control **5** or **6** repeatedly until you reach the « MY SAFETY PERSON » menu or, depending on vehicle, the « DRIVING ASSIST » menu. Press the **OK** switch **7**;
- press the **5** or **6** control repeatedly to reach the « Lane keeping » menu.
- press the **OK** switch **7** again to activate or deactivate the function:

-  function activated;

-  function deactivated.
- When the function is deactivated, the warning light  is displayed in yellow on the instrument panel.

### Operation



When the function is activated, the  warning light and the left-hand and right-hand line indicators **8** are displayed in grey on the instrument panel.

### The function is set to operate when:

- the vehicle speed is between approximately 40 mph (65 km/h) and 106 mph (170 km/h);

- the warning light  and the left-hand or right-hand line indicators **8** appear in white on the instrument panel.

**The function intervenes if the vehicle:**

- approaches a roadside without activating the direction indicators;
- crosses a continuous line without activating the direction indicators;
- crosses a dashed line without activating the direction indicators, if the « Dashed line Intervention » setting is selected.

In these cases:

- the function triggers an action on the vehicle's steering system to correct the vehicle trajectory;
- and

- the warning light  is displayed in yellow and the indicator **8** for the crossed line turn yellow on the instrument panel.

If corrective action taken on the steering system is not sufficient, the warn-

ing light  is displayed in red and the indicator **8** on the side of the crossed line turns to red on the instrument panel. This is accompanied by a vibration on the steering wheel.

## ADDITIONAL DRIVING AID FUNCTIONS

When the « Dashed line Intervention » setting is not selected, if the vehicle crosses a dashed line without activating the indicator lights, and there is no roadside close enough to the line.

In this case, the function **warns** the driver:

- by a vibration in the steering wheel; and

- the warning light  is displayed in red and the indicator **B** on the side of the crossed line turns red on the instrument panel.

**Note:** in curves, the function allows to slightly cut the turn.

### Special case

#### « Keep control » warning

- If the system is in intervention and no longer detects driver activity on the steering wheel, the « Keep control » message appears on the instrument panel accompanied by an audible sig-

nal and the yellow warning light  appears until the driver has taken control of the vehicle.

- If the system has been in intervention for too long, the message « Keep control » will appear on the instrument panel accompanied by an audible sig-

nal and the yellow warning light  and the flashing indicator **B** on the side of the relevant sideline, until the driver has taken control of the vehicle.



You can interrupt the trajectory correction at any time by moving the steering wheel.

### Settings

#### Vehicle equipped with multimedia screen **3**

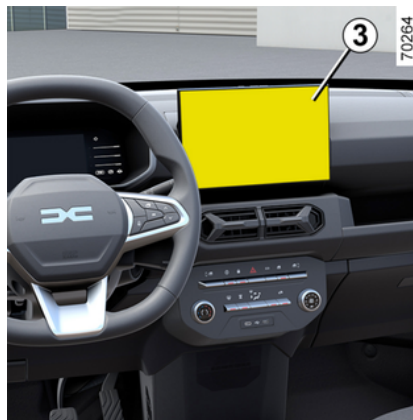

To access the multimedia screen function settings **3**, refer to the multimedia instructions:

- « Dashed line Intervention »: use this setting to select the response of the function if the vehicle crosses a dashed line without activating one of the direction indicators:

- selected setting: the function may trigger an action on the vehicle's steering system to correct the vehicle trajectory;
- setting not selected: the function can warn the driver by means of a vibration at the steering wheel without correcting the vehicle trajectory.

- « Vibration »: adjust the steering wheel vibration for the « Lane departure prevention » function;
- « Departure anticipation »: adjust the line detection sensitivity level. To do this, select:

- « Late »: line detected when crossed;
- « Standard »: line detected when approached;
- « Early »: line detected when near.



Please refer to the multimedia instructions for further information.

#### Vehicle not equipped with multimedia screen

## ADDITIONAL DRIVING AID FUNCTIONS



Vehicle stationary:

- press switch **4** repeatedly to access the  menu;
- repeatedly press control **5** or **6** to access the «  Vehicle Setting » menu. Press the **OK** switch **7**;
- press control **5** or **6** repeatedly until you reach the « DRIVING ASSIST » menu. Press the **OK** switch **7**;
- scroll repeatedly by pressing control **5** or **6** to reach the
  - « Lane Departure Vibration »;or
- « Lane Keeping sensitivity »;

- « Dashed line correction » menu.
- Press the **OK** switch **7**;
- scroll repeatedly pressing control **5** or **6** to adjust the setting. Press the **OK** switch **7**.
- « Dashed line correction »: use this setting to select the response of the function if the vehicle crosses a dashed line without activating one of the direction indicators:
  - selected setting: the function may trigger an action on the vehicle's steering system to correct the vehicle trajectory;
  - setting not selected: the function can warn the driver by means of a vibration at the steering wheel without correcting the vehicle trajectory.
- « Lane Departure Vibration »: adjust the steering wheel vibration for the « Lane departure prevention » function;
- « Lane Keeping sensitivity »: adjust the line detection sensitivity level. To do this, select:
  - « Late »: line detected when crossed;
  - « Standard »: line detected when approached;
  - « Early »: line detected when near.

### Temporary unavailability / function inhibition

The system is temporarily unavailable or disabled when:

- very fast lane departure;
- driving continuously on a line;
- approximately four seconds after changing lanes;
- tight bends;
- impaired visibility;
- one of the direction indicators is activated;
- activating the hazard warning lights;
- reverse gear engaged;
- strong acceleration;
- the lane width changes;
- operation of the anti-lock braking system;
- operation of the Electronic Stability Program ESC;
- the active emergency braking system is triggered.

When the function is unavailable, the



warning light  and the left-hand and right-hand line indicators **2** turn grey on the instrument panel.

Camera view is obstructed or blocked.

### Automatic deactivation

The function is automatically deactivated when:

## ADDITIONAL DRIVING AID FUNCTIONS

- Electronic Stability Program ESC is deactivated or malfunctioning;
  - The anti-lock braking system is malfunctioning;
  - A towbar is electrically connected to the trailer hitch socket;
  - the  warning light is displayed.
- When the function is deactivated, the warning light  is displayed in yellow on the instrument panel.

### Operating faults

When the system detects an operating fault:

- the warning light  is displayed in yellow on the instrument panel;

In some cases, it is accompanied by the message:

- the message « Driving Assist unavailable »;

or

- the message « Check Driving Assist »;

or

- the message « Check front camera »;

Consult an approved dealer.

# ADDITIONAL DRIVING AID FUNCTIONS

## Warnings



This function is an additional driving aid. This function is not under any circumstances intended to replace the due care and attention of the driver, who should at all times be in control of the vehicle.

### **System servicing/repairs**

- In the event of an impact, the camera alignment may be changed, and its operation may consequently be affected. Deactivate the function and consult an authorised dealer.
- Any work in the area where the camera is located (repairs, replacements, windscreen modifications etc.) must be carried out by a qualified professional.

Only an authorised dealer is qualified to service the system.

### **In the event of system disturbance**

Some conditions can disturb or damage the operation of the system, such as:

- windscreen obscured (by dirt, ice, snow, condensation etc.);
- a complex environment (tunnel etc.);
- poor weather conditions (snow, rain, hail, black ice etc.);
- poor visibility (night, fog etc.);
- the road markings are irregular or difficult to distinguish (e.g. partially erased, excessive spacing, distorted road surface);
- being dazzled (glaring sun, lights of vehicles travelling in the opposite direction etc.);
- the road is narrow, winding or undulating (tight bends etc.);
- closely following a vehicle travelling in the same lane.

In this case, the « Lane departure prevention » function may be activated incorrectly or not at all.

### **Risk of unwanted, incorrect correction or no correction of trajectory.**

#### **Deactivating the function**

You must disable the function if:

- the area of the camera has been damaged (on the windscreen side or the interior rear-view mirror side);
- the road is slippery (snow, black ice, aquaplaning, gravel etc.);
- poor visibility (night, fog etc.);

## ADDITIONAL DRIVING AID FUNCTIONS

- the windscreen is cracked or distorted (do not carry out windscreen repairs in this area; have it changed by an Authorised Dealer);
- the vehicle is towing a trailer or a caravan;
- the vehicle is entering an area with several surface markings (an area with road works etc.).

## ADDITIONAL DRIVING AID FUNCTIONS

### Active emergency braking

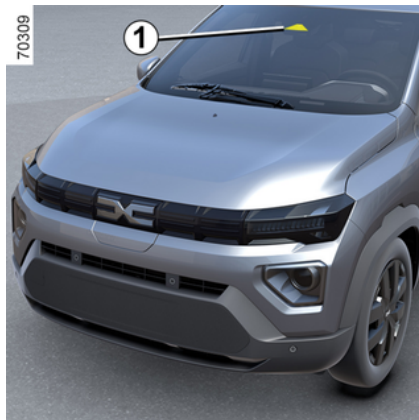

The system uses information from the camera **1**, to determine the distance from your vehicle:

– from the vehicle ahead in the same lane;

or

– from any oncoming vehicles in the context of a manoeuvre to change direction;

or

– and vehicles passing perpendicularly;

or

– and stationary vehicles;

or

– surrounding pedestrians and cyclists.

The system informs the driver if there is a risk of frontal collision to enable appropriate emergency manoeuvres (pressing the brake pedal and/or turning the steering wheel).

Depending on the reactivity of the driver, the system can assist with braking in order to limit damage or prevent a collision.

**The system is otherwise inactive and does not trigger an alert.**



This function is an additional driving aid.

This function is not under any circumstances intended to replace the due care and attention of the driver, who should at all times be in control of the vehicle.



**This system can apply maximum braking to the vehicle** until it is completely stationary if necessary.

For safety reasons, always wear your seat belt when travelling in your vehicle and make sure that it is loaded so that no items can be thrown forward and hit the occupants.

### Location of the camera **1**

Make sure the windscreen is not obscured (by dirt, mud, snow, condensation etc.).

### Operation

When driving, when there is a risk of collision, the system:

– **alerts you of a collision risk:** the « Detected obstacle » message appears on the instrument panel accompanied by a beep.

**Note:** if the driver presses the brake pedal and the system still detects a risk of collision, the braking force may be increased if it is not sufficient to prevent the collision.

– **can trigger braking:** if the driver does not react to the alert and the colli-

## ADDITIONAL DRIVING AID FUNCTIONS

sion becomes imminent, the red warning light  and the « Brake » message are displayed on the instrument panel accompanied by a beep.

### Note:

- if the driver uses the vehicle controls (steering wheel, pedals, etc.) the system may delay its reaction or not activate;
- if active emergency braking has caused the vehicle to stop, the vehicle is kept stationary for a short time. Beyond this time limit, the driver must keep the vehicle stationary by holding their foot on the brake pedal;
- after the system activates braking, the « Advanced Safety triggered » message will be displayed.



In the event of an emergency manoeuvre, you can stop the braking at any moment by:

- tapping the accelerator pedal;
- or
- turning the steering wheel as a collision avoidance manoeuvre.



### Special features of warnings

Depending on the speed, the warning and braking may be activated simultaneously.

### Vehicle detection

#### Detection of vehicles travelling in the same lane

The risk of a collision with the vehicle in front of you in the same lane is detected by the system when:

- your vehicle is travelling at a speed between approximately 3 mph (5 km/h) and 81 mph (130 km/h).

#### Detection of oncoming vehicles in the context of a manoeuvre to change direction

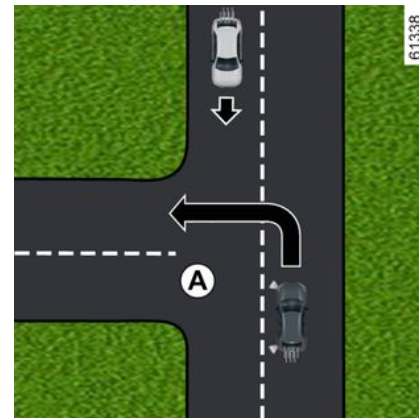

When you wish to change direction (e.g. **A**), oncoming vehicles are detected by the system when:

- your vehicle is travelling at a speed between approximately 4 mph (7 km/h) to 19 mph (30 km/h);
- you have activated the direction indicator light.

#### Detection of vehicles crossing the lane perpendicularly

Vehicles crossing the lane perpendicularly are detected by the system when:

- your vehicle is travelling at a speed between approximately 3 mph (5 km/h) and 53 mph (85 km/h).

#### Detection of vehicles stopped in the lane

## ADDITIONAL DRIVING AID FUNCTIONS

Stationary vehicles are detected by the system when:

- your vehicle is travelling at a speed between approximately 3 mph (5 km/h) and 81 mph (130 km/h).

### 3 **Detection of pedestrians and cyclists**

#### **Detection of pedestrians and cyclists in the same lane**

The system detects pedestrians and cyclists when:

- your vehicle is travelling at a speed between approximately 3 mph (5 km/h) and 53 mph (85 km/h).

#### **Detection of pedestrians and cyclists when changing direction**

The system detects pedestrians and cyclists when:

- your vehicle is travelling at a speed between approximately 4 mph (7 km/h) and 19 mph (30 km/h).

### **Activation/deactivation**

 Depending on the vehicle, according to the length of time following the last time the engine was stopped, the function is reactivated:

- when the vehicle is unlocked;  
or
- when a door is opened;  
or
- when the engine is restarted.

### **Activating, deactivating the system from the multimedia screen 2**

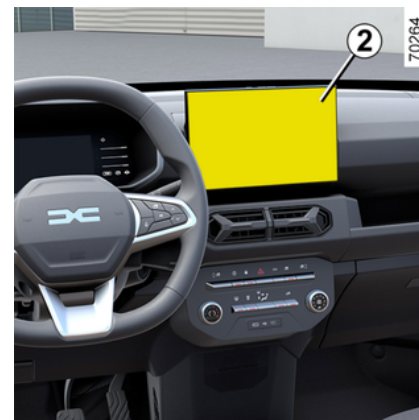

To activate or deactivate the function, please refer to the multimedia instructions.



Select « ON » or « OFF ».



### **Activating, deactivating the system from the trip computer**

## ADDITIONAL DRIVING AID FUNCTIONS



Vehicle stationary:

- press switch **3** repeatedly to access the  menu;
- repeatedly press control **4** or **5** to access the «  Vehicle Setting » menu. Press the **OK** switch **6**;
- press control **4** and **5** repeatedly until you reach the « DRIVING ASSIST » menu. Press the **OK** switch **6**;
- scroll repeatedly by pressing control **4** or **5** to reach the « Active braking » menu;
- press the switch **6 OK** again to activate or deactivate the function:

-  function activated;
-  function deactivated.

Upon deactivation of the system, the

 warning light comes on in yellow on the instrument panel.

When the system is activated, the warning light disappears.

### Settings



For safety reasons, carry out any adjustments while the vehicle is stationary.

### Adjusting settings from multimedia screen 2

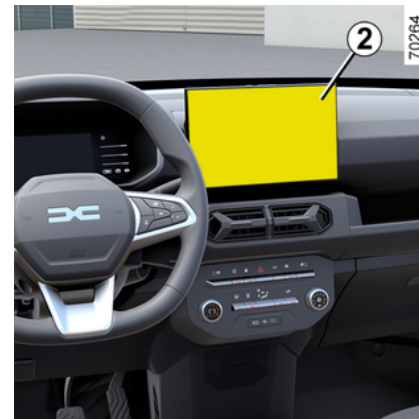

With the vehicle stationary, to access the function settings from the multimedia screen **2**; refer to the multimedia instructions:

- « Warning Anticipation »: adjust the sensitivity level. To do this select:
  - « Late »
  - « Standard »
  - « Early »



Please refer to the multimedia instructions for further information.

### Adjusting settings from the trip computer 3

## ADDITIONAL DRIVING AID FUNCTIONS



Vehicle stationary:

- press the switch **3** repeatedly to access the  menu;
- repeatedly press control **4** or **5** to access the «  Vehicle Setting » menu. Press the **OK** switch **6**;
- press control **4** or **5** repeatedly until you reach the « DRIVING ASSIST » menu. Press the **OK** switch **6**;
- scroll repeatedly by pressing control **4** or **5** to reach the « Active braking sensitivity » menu. Press the **OK** switch **6**;
- scroll repeatedly pressing control **4** or **5** to adjust the setting. Press the **OK** switch **6**.

### Temporarily not available

If the system detects a temporary fault

the warning light  comes on in yellow on the instrument panel.

The possible causes are:

- the system is temporarily blinded (glare from the sun, dipped beam headlights, bad weather conditions etc.). The system will be operational again when visibility conditions are better;
- the system is temporarily disrupted (for example: the windscreen is obscured by dirt, mud, snow, condensation, etc.). In this case, park the vehicle and switch off the engine. Clean the windscreen. The next time the engine is started, after five or ten minutes of driving, the warning light and the message disappear. If this is not the case, this may arise from another cause; contact an Approved Dealer.

### Operating faults

When the function detects an operating fault, the warning light 

comes on in yellow on the instrument panel.

Consult an approved dealer.

# ADDITIONAL DRIVING AID FUNCTIONS

## Warnings



This function is an additional driving aid. This function is not under any circumstances intended to replace the due care and attention of the driver, who should at all times be in control of the vehicle.

The triggering of this function may be delayed or prevented when the system detects clear signs of control of the vehicle by the driver (action on the steering wheel, pedals etc.).

The system cannot be activated when:

- the Electronic Stability Control (ESC) has been triggered.

### **System servicing/repairs**

– In the event of an impact, the camera alignment may be changed, and its operation may consequently be affected. Deactivate the function and consult an authorised dealer.

– Any work in the area where the camera is located (repairs, replacements, windscreen modifications etc.) must be carried out by a qualified professional.

Only an authorised dealer is qualified to service the system.

## ADDITIONAL DRIVING AID FUNCTIONS



### **System disturbance**

Some conditions can disturb or damage the operation of the system, such as:

- poor weather conditions (snow, rain, hail, black ice etc.) ;
- poor visibility (night, fog etc.) ;
- poor contrast between the object (vehicle, pedestrian etc.) and the surrounding area (e.g. pedestrian dressed in white located in a snowy area etc.) ;
- being dazzled (glaring sun, lights of vehicles travelling in the opposite direction etc.) ;
- windscreen obscured (by dirt, ice, snow, condensation etc.) ;
- ...

**In these conditions, the system may not react, may warn the driver or may brake inadvertently.**

### **Limitation of the system operation**

- Each time the vehicle is started, the system carries out a calibration according to the vehicle surroundings and may be inactive for a length of time between approximately two to five minutes of driving;
- an oncoming vehicle will not trigger any warning or system action if the conditions detailed in the paragraph on « Detection of oncoming vehicles in the context of a manoeuvre to change direction »;
- The camera should be kept clean and free of any modifications in order to ensure the proper operation of the system;
- the system may not respond to small vehicles as effectively as to other vehicles;
- the system may not operate properly when the road surface is slippery (rain, snow, black ice, etc.) ;
- to ensure correct operation, the system needs to distinguish the entire obstacle. So the system cannot detect:
  - pedestrians/cyclists in the darkness or in poor lighting conditions;
  - partially visible pedestrians/cyclists;
  - pedestrians less than approximately 80 cm;
  - pedestrians carrying large objects;
  - ...

**In these conditions, the system may not react, may warn the driver or may brake inadvertently.**

## ADDITIONAL DRIVING AID FUNCTIONS



### **Deactivating the function**

You must deactivate the function if:

- the camera area has been damaged (e.g. on the inside or outside of the windscreen);
- the vehicle is being towed (breakdowns);
- the windscreen is cracked or distorted (do not carry out windscreen repairs in this area; have it changed by an approved dealer);
- you are not driving on a paved road.

**In the event of the system behaving abnormally, deactivate it and consult an authorised dealer.**

### **Halting the function**

You can halt the active braking function at any time by tapping the accelerator pedal or by turning the steering wheel in a collision avoidance manoeuvre.

# ADDITIONAL DRIVING AID FUNCTIONS

## Driver vigilance warning

The driver vigilance warning is a function that analyses the behaviour of the driver (driving style, vehicle steering, etc.) and alerts them if there is a risk of falling asleep.

It takes into account indicators such as:

- steering wheel movements;
- driver actions on other systems (indicators, brake pedal, etc.).



This function is an additional driving aid in case of risk of fatigue. The function does not operate on the vehicle. The function cannot, under any circumstances, replace the driver's responsibility during driving.

The driver must always adapt their driving according to their alertness, regardless of the system's indications.

## Operation

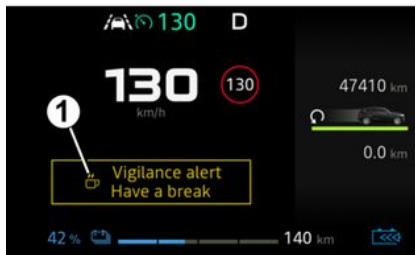

70396



The function is set to notify the driver if:

- a few minutes have elapsed since the vehicle last stopped;
- the vehicle speed is greater than approximately 43 mph (70 km/h).

If there is a risk of fatigue or impaired attention, the « Vigilance alert Have a break » **1** message is displayed on the instrument panel, accompanied by a sound.

Press the switch **2 OK** to clear the warning. It is advisable to stop as soon as possible for a break.

After deleting the message, the system continues vigilance monitoring and issues a new warning if necessary.



The driver vigilance warning constantly monitors the driver's attention and can provide several warnings per journey. The system resets every time the engine is started.

## ADDITIONAL DRIVING AID FUNCTIONS

### Activation/deactivation



For safety reasons, carry out any adjustments while the vehicle is stationary.



Depending on the vehicle, depending on the length of time following the last time the engine was stopped, the alerts are reactivated:

- when the vehicle is unlocked;
- or
- when a door is opened;
- or
- when the engine is started.



When the alerts are deactivated, the system continues to assess the driver's state of fatigue.

### Activating, deactivating the alerts using the switch 3



The alerts can be deactivated or activated using « Perso » mode in the « My Safety » function ➔ 149.

If the alerts have previously been deactivated using « Perso » mode:

- **to deactivate the alerts**, press the button 3 twice. The indicator light on the button 3 goes out;
- **To reactivate the alerts**, press the button 3 once. The indicator light on the button 3 lights up.

### Activating and deactivating from the multimedia screen 4



To activate or deactivate the alerts, please refer to the multimedia instructions.



Select « ON » or « OFF ».

### Activating, deactivating from the trip computer 5

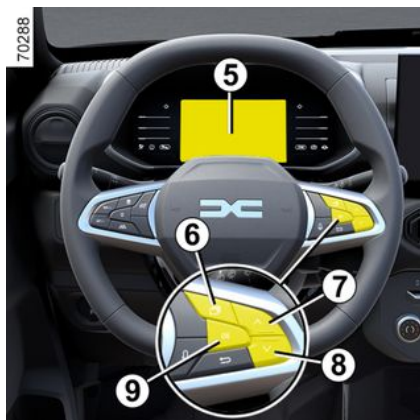
## ADDITIONAL DRIVING AID FUNCTIONS



Vehicle stationary:

- press switch **6** repeatedly to access the  menu;
- repeatedly press control **7** or **8** to access the «  Vehicle Setting » menu. Press **OK** switch **9**;
- press control **7** or **8** repeatedly until you reach the « DRIVING ASSIST » menu. Press **OK** switch **9**;
- press the **7** or **8** control repeatedly to reach the « Vigilance warning » menu;
- press the **OK** switch **9** again to activate or deactivate the alerts:

-  alert activated;

-  alert deactivated.

### Limitations of system operation

Some conditions can disrupt or damage the system operation, for example:

- certain driving styles (incorrect driving etc.);
- driving on a road in poor condition;
- strong side wind;
- The clock is wrongly configured (depending on vehicle);
- winding roads;
- trailer traction.

### Operating faults

If the system detects a fault, the « vigilance monitoring to check » accompanied by the warning light  message are displayed on the instrument panel.

Have the system checked by an authorised dealer.

Have the system checked by an authorised dealer.

### Detection of road signs

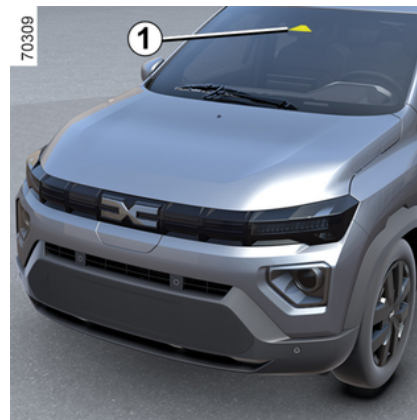

The system displays speed limits on the instrument panel according to road signs detected on the side of the road.

It mainly uses information taken from the camera **1** attached to the windshield behind the rear-view mirror.

Depending on the country, the system also uses information from a map subscription to interpret certain signs (town entrance, etc.).

The sign displayed on the instrument panel changes when a road sign is detected by the system.

Once the speed limiter or the cruise control is activated, you can adapt the limited speed setpoint to the speed

## ADDITIONAL DRIVING AID FUNCTIONS

limit displayed on the instrument panel by the system (➔ 173 and ➔ 176).

If the detected speed limit is exceeded, the road sign displayed on the instrument panel is modified to inform the driver.

### Location of the camera 1

Make sure the windscreen is not obscured (by dirt, mud, snow, condensation etc.).

### Special features

#### For vehicles with a map subscription:

- if the vehicle is travelling in a country where the speed units differ from those of the vehicle, the system displays the speed limit sign in the unit of the country, alongside the speed limit converted to the unit used by the vehicle's instrument panel;
- for countries where the speed limit is reduced during rainy weather on some types of roads, the system may alter the detected speed limit after a few seconds of the windscreen wipers being activated.

**For vehicles without a map subscription:** when driving in a country where speed units differ from those on your vehicle, you can manually select the speed unit shown on the instru-

ment panel (e.g. change the unit from miles to kilometres) in order to display accurate information ➔ 106.

**Note:** the system does not take into account exceptional speed limit measures, such as peak pollution days.

### Operation

#### Warning lights

**3.** Additional road signs (start of no overtaking zone).

If the detected speed limit is exceeded, a circle flashes around the road sign (warning light 2) accompanied, depending on the vehicle, by a beep emitted for a few seconds to warn you.

It remains illuminated on the instrument panel as long as the vehicle is exceeding the detected speed limit.

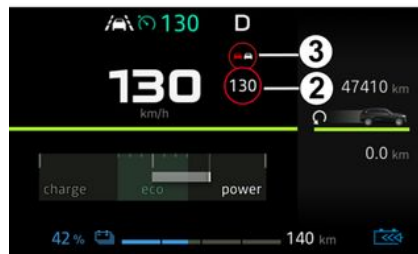

The function displays the following warning lights:

**2.** Speed limit signs and additional speed limit signs (speed on exit ramp with arrow, speed with a caravan, speed limit with length of application, etc.)

## ADDITIONAL DRIVING AID FUNCTIONS

### **Map subscription**

Road sign detection is associated with a map subscription.

**Note:** If there is no map for a country, a message will appear on the multimedia screen to inform and for downloading the map information relating to the country.

**To manage the subscription, please refer to the multimedia instructions.**

If there is no subscription, the system will be limited to taking into account the speed limit signs when they are detected by the camera.

The system will no longer take into account information related to the maps. The speed limit availability may be affected.

### Activation/deactivation



For safety reasons, carry out any adjustments while the vehicle is stationary.

 Depending on the length of time following the last time the engine was stopped, the alerts are reactivated:

- when the vehicle is unlocked;
- or
- when a door is opened;
- or
- when the engine is restarted.

### Activating, deactivating overspeed sound alerts using the switch 4

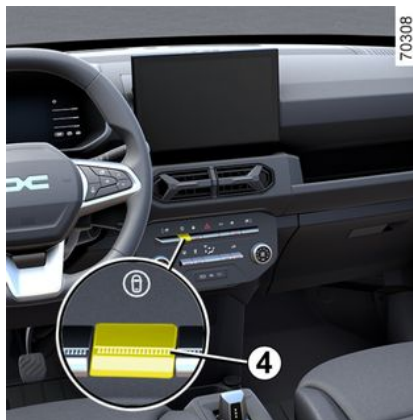

The sound alerts can be deactivated or activated using « Perso » mode in the « My Safety » function ➔ 149.

If the sound alerts have previously been deactivated using « Perso » mode:

- **to deactivate the alerts**, press the button 4 twice. The indicator light on the button 4 goes out;
- **to reactivate alerts**, press the button 4 once. The indicator light on the button 4 lights up.

### Activating, deactivating overspeed sound alerts from the multimedia screen 5

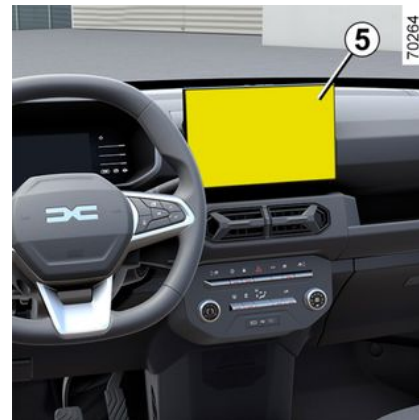

To activate or deactivate the sound alert, please refer to the multimedia instructions.



## ADDITIONAL DRIVING AID FUNCTIONS

Select « ON » or « OFF ».



### Activating, deactivating the over-speed sound alert from the trip computer



Vehicle stationary:

- press switch **6** repeatedly to access the  menu;
- repeatedly press control **7** or **8** to access the «  Vehicle Setting » menu. Press the **OK** switch **9**;
- press control **7** or **8** repeatedly until you reach the « DRIVING ASSIST » menu. Press **OK** switch **9**;
- press control **7** or **8** repeatedly to reach the « Speed Alert » menu;

- press the **OK** switch **9** again to activate or deactivate the sound alert:

-  alert activated;
-  alert deactivated.

### Variation of the limited speed or cruising speed



To adapt the speed limiter and cruise control setpoint to the detected speed limit, press the **10** switch.

### Temporary unavailability

If the system is unavailable for reasons related to the camera or map data, the

yellow  symbol is displayed on

the instrument panel. If there is still a problem, contact an approved dealer.

The system cannot detect the speed limit if:

- the windscreen is not clean;
- the camera is blinded by the sun;
- there is insufficient visibility (fog, etc.);
- the signs are not legible (snow, etc.) or are hidden (by another vehicle or by trees);
- map information is not up to date.

**Note:** when the front camera is obscured, the « Front camera without visibility » message is displayed on the instrument panel. Clean the windscreen area in front of the camera.

### Operating faults

When the system detects an operating

fault, the yellow  symbol is displayed on the instrument panel.

In some cases, they are accompanied by the following message:

- « Driving assist unavailable »;
- or
- « Check Front camera »;
- or

– « Check Driving assist »;

Consult an approved dealer.

# ADDITIONAL DRIVING AID FUNCTIONS

## Warnings



This function is an additional driving aid. This function is not under any circumstances intended to replace the due care and attention of the driver, who should at all times be in control of the vehicle.

The driver must always adapt their speed to the highway code and traffic conditions, regardless of system indications.

The system may not detect all speed limit signs or may interpret them incorrectly.

The driver must not ignore road signs undetected by the system and should give priority to complying with the actual road signs and the highway code.

In the event of poor visibility (fog, snow, frost, etc.), it is possible that the system may not indicate the correct speed to the driver.

## SPEED LIMITER

The speed limiter function controls the engine to help you not to exceed a driving speed that you have chosen, known as the **limit speed**.

The speed limiter function can be activated from 0 mph to 112 mph (180 km/h).



You can link the speed limiter to the « Road sign detection » function → 168.

### Controls

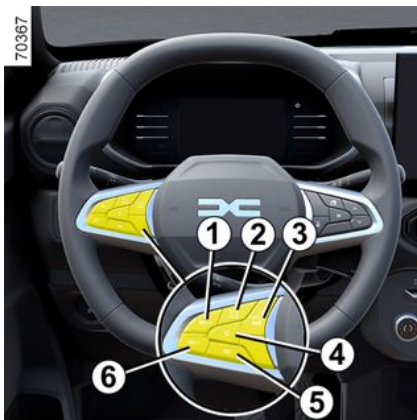

1. Switch to activate and increase the limit speed (**SET/+**).

2. Depending on the vehicle, road sign detection activation switch → 168.

3. Mode switch to change state between **OFF** / speed limiter / cruise control.

4. Switch the function to standby, with limit speed stored (**0**).

5. Reminder of the stored limit speed (**RES**).

6. Switch to activate and decrease the limited speed (**SET/-**).

When the mode « **OFF** » is selected before the ignition is switched off, the « Speed limiter » function will be activated by default the next time the vehicle is started.

### Driving

When a limit speed has been set but not yet reached, driving is similar to driving a vehicle without the speed limiter function.

Once you have reached the stored speed, no effort on the accelerator pedal will allow you to exceed the programmed speed except in an emergency (refer to information on « Exceeding the limit speed »).

### Switching on

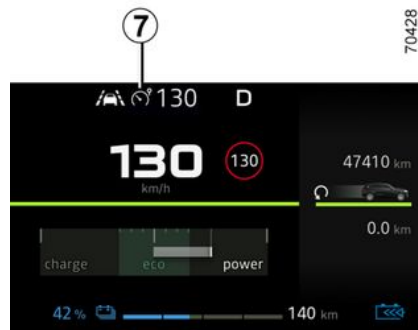

70428

3

Press switch **3** as many times as necessary until the light **7** lights up grey on the instrument panel. The « Limiter ON » message appears on the instrument panel accompanied by dashes to indicate that the speed limiter function is activated and waiting for a limit speed to be stored.

To store the current speed, press the switch **1 (SET/+)** or the switch **6 (SET/-)**: the limit speed replaces the dashes and, depending on the vehicle, the warning light **7** appears in white.

The minimum stored speed is 19 mph (30 km/h).

## SPEED LIMITER



Please note that you must keep your feet close to the pedals in order to react in an emergency.

3

### Varying the limit speed

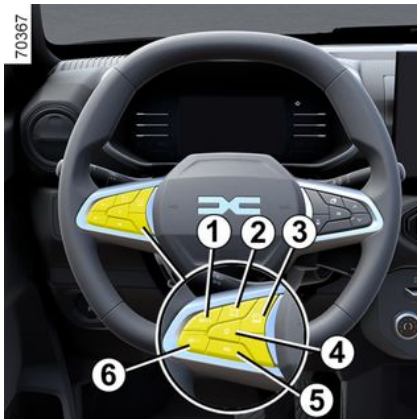

The limit speed may be changed by pressing repeatedly or holding down:

- the switch **1 (SET/+)** to increase the speed;
- the switch **6 (SET/-)** to reduce the speed.



The speed limiter function is in no way linked to the braking system.

### Exceeding the limit speed

It is possible to exceed the limit speed at any moment. To do this, press the accelerator pedal **firmly down** beyond the point of resistance.

While the speed is being exceeded, the programmed speed displayed on the instrument panel flashes.

Then, release the accelerator pedal: the speed limiter function will return as soon as you reach a speed lower than the memorised speed.

### Limited speed cannot be maintained

When driving down a steep gradient, the system is unable to maintain the limited speed: the stored speed will flash in red on the instrument panel and a beep sounds at regular intervals to inform you of this situation.



If the speed limiter is not available (after several attempts to activate), contact an approved dealer.

### Putting the function on standby

The speed limiter function is suspended when you press switch **4 (0)**.

The limit speed is stored and displayed in grey on the instrument panel.

### Recalling the limit speed

If a speed has been stored, it can be recalled by pressing the switch **5**.



When the speed limiter is set to standby, press switch **6 (SET/-)** or switch **1 (SET/+)** to reactivate the function without taking into account the stored speed: it is the speed at which the vehicle is moving that is taken into account.

# SPEED LIMITER

## Switching off the function

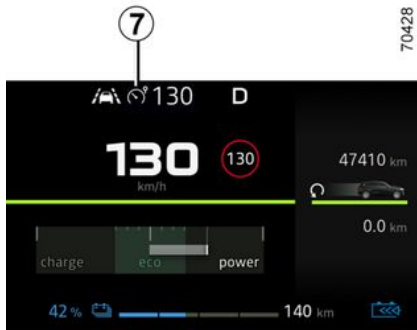

The speed limiter function is interrupted when:

- you press the switch **3** until the message « Assist. Driving Off » appears on the instrument panel. In this case, there is no stored speed;
- you press the switch **3** until the light



appears on the display. In this case the cruise control is selected and there is no stored speed.

The **7** warning light disappears from the instrument panel to confirm that the function has stopped.

## CRUISE CONTROL

The cruise control function controls the engine to help you to maintain a driving speed that you have chosen, known as the **cruising speed**.

The cruise control function can be activated from 19 mph (30 km/h) to 112 mph (180 km/h).



You can link the cruise control function to the « Road sign detection » function

→ 168



The cruise control function is in no way linked to the braking system.

### Controls

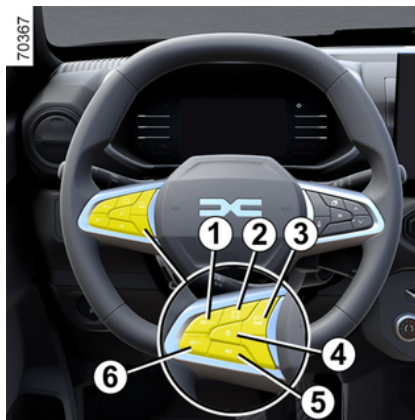

1. Switch to activate and increase the cruising speed (**SET/+**).
2. Depending on the vehicle, road sign detection activation switch  → 168.

3. Mode switch to change state between **OFF** / speed limiter / cruise control.

4. Switch the function to standby, with cruising speed stored (**0**).

5. Reminder of the stored cruising speed (**RES**).

6. Switch to activate and decrease the cruising speed (**SET/-**).

When the mode « **OFF** » is selected before the ignition is switched off, the « Speed limiter » function will be activated by default the next time the vehicle is started.



This function is an additional driving aid.

It can under no circumstances replace the

driver's responsibility to respect speed limits or to be vigilant.

The driver must always be in control of the vehicle.

Cruise control must not be used in heavy traffic, on winding or slippery roads (black ice, aquaplaning, gravel) and during bad weather (fog, rain, side winds etc.).

**There is a risk of accidents.**

# CRUISE CONTROL

## Switching on

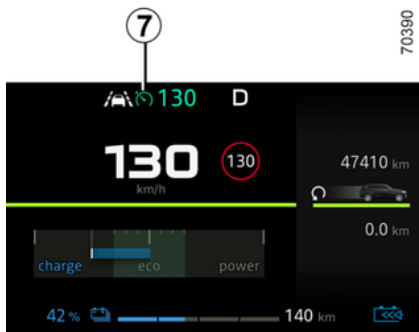

Press switch **3** as many times as necessary until the light **7** lights up grey on the instrument panel.

The « Cruise control ON » message appears on the instrument panel, accompanied by dashes to indicate that the cruise control function is activated and waiting to store a cruising speed.

## Activating cruise control

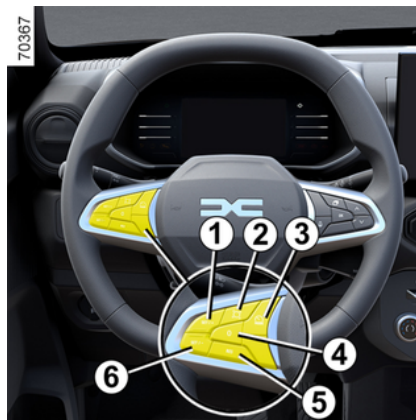

While the vehicle is moving a steady speed (above approximately 19 mph (30 km/h)), press the switch **6** (SET/-) or the switch **1** (SET/+): the function is activated and the current speed is taken into account.

The cruising speed replaces the dashes. Cruise control is confirmed when the memorised speed and warning light appear in green **7**.

If you try to activate the function below 19 mph (30 km/h), the « Speed invalid » message will be displayed and the function will remain deactivated.

## Driving

Once a cruising speed is registered and the cruise control function is active, you may lift your foot off the accelerator pedal.



Please note that you must keep your feet close to the pedals in order to react in an emergency.

## Adjusting the cruising speed

The cruising speed may be changed by repeatedly pressing the:

- the switch **6** (SET/-) to reduce the speed;
- the switch **1** (SET/+) to increase speed.



press and hold one of the switches to modify speed by successive increments

## Exceeding the cruising speed

The cruising speed may be exceeded at any time by depressing the accelerator pedal.

## CRUISE CONTROL

While it is being exceeded, the cruising speed flashes on the instrument panel.

Then, release the accelerator pedal: after a few seconds, the vehicle will automatically return to its set cruising speed.

### 3 Cruising speed cannot be maintained

When driving down a steep gradient, the system may be unable to maintain the cruising speed: the memorised speed will flash on the instrument panel.



If the cruise control is no longer available (after several attempts to activate it), contact an Approved Dealer.

### Putting the function on standby

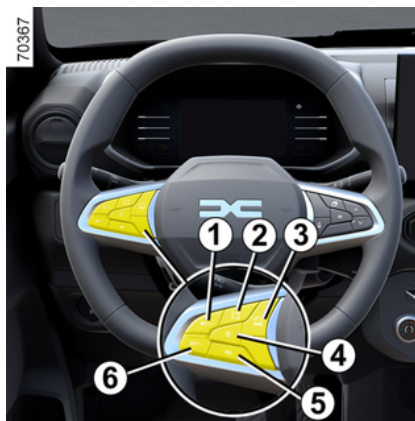

The function is set to standby if you:

- the switch **4 (0)**;
- the brake pedal;
- shifting to neutral position.

The cruising speed is stored and displayed in grey on the instrument panel.

### Returning to the cruising speed

If a speed is stored, it can be recalled, once you are sure that the road conditions are suitable (traffic, road surface, weather conditions, etc.). Press the switch **5 (RES)** if the vehicle speed is above 19 mph (30 km/h).

When the speed is stored, cruise control activation is confirmed in green on the cruising speed and, depending on

the vehicle, the **7** warning light is displayed.



if the speed previously stored is much higher than the current speed, the vehicle will accelerate more rapidly to reach this threshold.

When the cruise control is on standby, press switch **6 (SET/-)** or switch **1 (SET/+)** to reactivate the cruise control function without taking into account the stored speed: it is the speed at which the vehicle is moving that is taken into account.

# CRUISE CONTROL

## Switching off the function

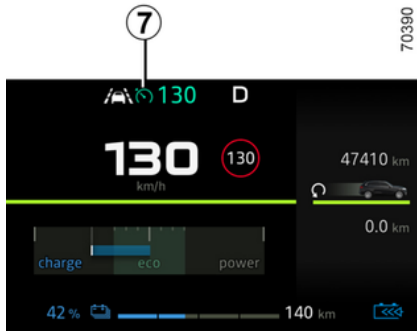

The cruise control function is interrupted when:

- you press the switch **3** until the message « Assist. Driving Off » appears on the instrument panel. In this case, there is no stored speed;
- you press the switch **3** until the light

 appears on the display. In this case the speed limiter is selected and there is no stored speed.

The **7** warning light disappears from the instrument panel to confirm that the function has stopped.

# PARKING AIDS

## Parking distance control

### Operating principle

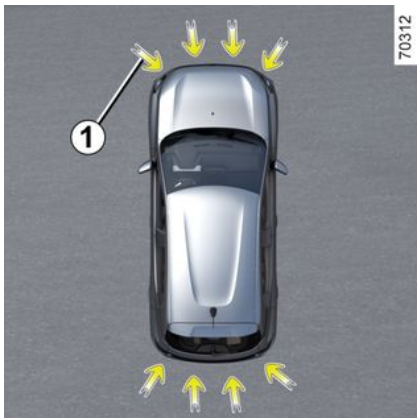

Ultrasonic sensors, indicated by arrows **1**, are fitted in the bumpers to detect obstacles near the vehicle.

The function alerts the driver via audible signals and a display representing the area where the obstacle was detected.

Depending on the equipment, the system detects obstacles behind, in front and to the sides of the vehicle.

The parking distance control system is only activated when the vehicle is driven at a speed below approximately 6 mph (10 km/h).

The function does not take into account towing or carrying systems that are not recognised by the system.



This function is an additional driving aid. Under no circumstances should it replace the driver's care or responsibility whilst reversing.

The driver should always be ready for sudden incidents while driving: always ensure that there are no small, narrow moving obstacles (such as a child, animal, pushchair, bicycle, stone, post, etc.) in the blind spot when manoeuvring.



An impact to the underside of the vehicle while manoeuvring (e.g. striking a post, raised kerb or other street furniture) may result in damage to the vehicle (e.g. deformation of an axle). To avoid any risk of accident, have your vehicle checked by an approved dealer.

### Location of the ultrasonic sensors **1**

Ensure that the area around the ultrasonic sensors indicated by the arrows **1** is not obscured (by dirt, mud, snow, a badly fitted/attached number plate), impacted, modified (including paintwork) or obstructed by any accessory fitted to the rear and/or, depending on the vehicle, to the front of your vehicle.

# PARKING AIDS

## Operation

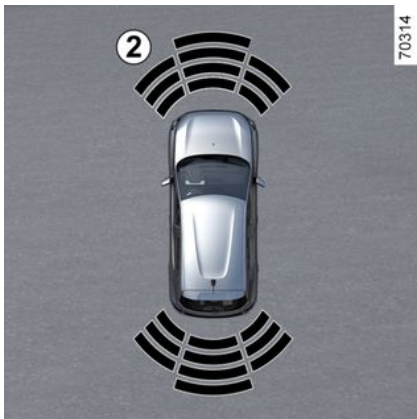

Depending on the vehicle, the display **2** shows the vehicle surroundings, accompanied by beeps.

## Obstacle detection

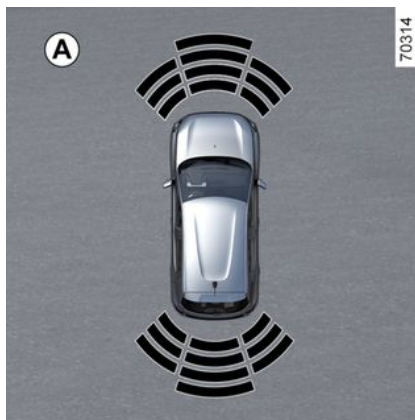

Most obstacles located near the rear and, depending on the equipment, the front of the vehicle are detected.

The frequency of the beep will increase as the obstacle approaches and will become a continuous beep at around 30 cm from an obstacle detected in front of the vehicle or behind it, depending on the vehicle.

Depending on the vehicle, the area where the obstacle has been detected is shown (display **A**). Depending on the vehicle, the area is displayed in green, orange (or yellow depending on the vehicle) or red, depending on the proximity of the detected obstacle.



In the event of a change in trajectory during a manoeuvre, the risk of collision with an obstacle may be signalled late.

## Activation/deactivation

### Activation/deactivation from the multimedia screen **3**



From the « Vehicle » world on your multimedia screen **3**, press the « Parking aids » menu.

Activate or deactivate areas covered by the ultrasonic detectors.

Please refer to the multimedia instructions for further information.

## PARKING AIDS

**Note:** the rear detection zone cannot be deactivated.

### Parking distance control automatic deactivation

The system is deactivated:

- when the vehicle speed is above approximately 6 mph (10 km/h);
- depending on the vehicle, when the vehicle is stationary for more than approximately five seconds and an obstacle is detected (such as when in a traffic jam, etc.);
- when you are in **N** or **P** position;
- when an operating fault is detected.

**Note:** depending on the vehicle, if the vehicle is fitted with a towbar recognised by the system, only the rear Park Assist function is deactivated.

### Settings



For safety reasons, carry out any adjustments while the vehicle is stationary.



Each time the vehicle is started, the function resumes the activation status saved the last time the engine was stopped.

### Settings from the multimedia screen

3





With the vehicle stationary, from the « Vehicle » world on the your multimedia screen **3**, press the « Parking aids » menu.

Please refer to the multimedia instructions for further information.

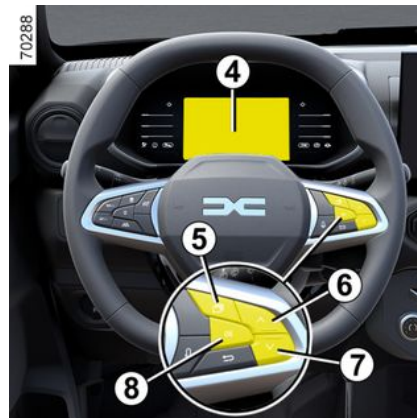
### Settings from the trip computer



Vehicle stationary:

- press switch **5** repeatedly to access the menu ;
- repeatedly press control **6** or **7** to access the «  Vehicle Setting » menu. Press the **OK** switch **8**;
- press control **6** or **7** repeatedly until you reach the « PARKING ASSIST » menu. Press the **OK** switch **8**;
- press the **6** or **7** control repeatedly to reach the « Bip volume » menu. Press the **OK** switch **8**;
- scroll repeatedly pressing control **6** or **7** to adjust the setting;
- press the **OK** switch **8**.

## PARKING AIDS

### Deactivating the system sound

(depending on the vehicle)

Activate or deactivate the parking distance control sound.

**Note:** if you mute the sound, when approaching an obstacle you will be alerted only by the display.

### Parking distance control audio volume

Adjust the Park Assist volume using the volume bar.



Each time the vehicle is started, the function resumes the activation status saved the last time the engine was stopped.

### Special cases

You can manually deactivate sound alerts or, depending on the vehicle, the detection zone concerned in the event that:

- towing, carrying or trailer equipment that is unrecognised by the system is present in front of the ultrasonic sensors;
- the ultrasonic sensors are damaged.

**Note: if the sound is deactivated,** the displays will continue to warn you erratically.

### Operating faults

When the system detects a malfunction: either a sound signal warns you for about three seconds when the reverse gear is engaged, accompanied by the « Check Parking sensors » message on the instrument panel, or the system does not produce a sound or display when the reverse gear is engaged.

Check that the ultrasonic sensors are clean.

If it the fault persists, consult an approved dealer.



When the vehicle is travelling at a speed below approximately 6 mph (10 km/h), some noises (motorcycle, lorry, pneumatic drill, etc.) may trigger the Park Assist system audible warnings.

# PARKING AIDS

## Guidelines



### **System servicing/repairs**

- In the event of an impact, the alignment of the ultrasonic sensors may be altered and its operation may consequently be affected. Deactivate the function and consult an authorised dealer.
- Any work in the area where the ultrasonic sensors are located (repairs, replacements etc.) must be carried out by a qualified professional.

Only an authorised dealer is qualified to service the system.

### **System disturbance**

Some conditions can disrupt or damage the system operation, for example:

- poor weather conditions (rain, snow, hail, black ice, etc.);
- some types of noise (motorcycle, lorry, pneumatic drill, etc.);
- fitting an non-compatible towing ball or hook.

### **Risk of false alarms or absence of warnings**

If the system behaves abnormally consult an authorised dealer.

### **Limitation of the system operation**

- The ultrasonic detection zones should be kept clean and free of any modifications in order to ensure the proper operation of the system.
- Small objects moving close to the vehicle (motorcycles, bicycles, pedestrians, etc.) may not be recognised by the system.
- The system may not detect obstacles that are too close to the vehicle.
- The system may not provide a warning when the other vehicles or obstacles are travelling at a significantly different speed.
- When there is a change in trajectory during a manoeuvre, the system may be slow in reporting obstacles

## PARKING AIDS

### Reversing camera

#### Operation



Depending on the variants,

When reverse gear is engaged, the camera **1** located at the rear of the vehicle transmits a view of the area behind the vehicle to the multimedia display **2** accompanied by three guide lines **3** or **4** (fixed and moving guide lines).



This system uses several guidelines for its operation (mobile for trajectory and fixed for distance). When the red zone is reached, use the bumper image to stop accurately.

**Note:** make sure that the reversing camera is not obscured (by dirt, mud, snow, condensation, etc.).

#### Fixed clearance gauge **3**

The fixed gauge includes coloured markers **A**, **B** and **C** indicating the distance behind the vehicle:

- **A** (red) approximately 30 centimetres from the vehicle;
- **B** (yellow) approximately 70 centimetres from the vehicle;
- **C** (green) approximately 150 centimetres from the vehicle.

This gauge remains fixed and indicates the vehicle trajectory if the wheels are in line with the vehicle.

#### Moving guide line **4**

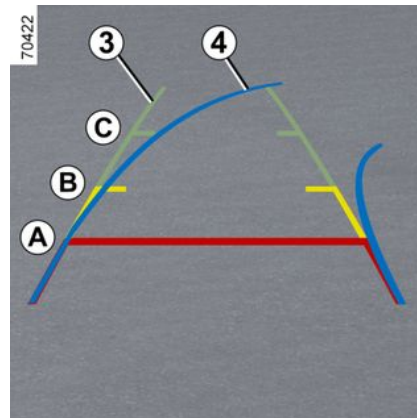

This is shown in blue on the multimedia screen **2**. It indicates the vehicle trajectory according to the position of the steering wheel.

## PARKING AIDS

### Settings



When reverse gear is engaged, from the multimedia screen **2** press

the  button to add or remove the guide lines and adjust the camera image settings (brightness, contrast, etc.).

Please refer to the multimedia instructions for further information.



Make sure that the camera is not obscured (by dirt, mud, snow, condensation etc.).

### « Zoom auto » function

If an obstacle is detected behind the vehicle, the function « Zoom auto » switches the current display to a top rear view.

To activate/deactivate the « Zoom auto » function, refer to the multimedia instructions.



The screen shows a reverse mirror image.

The frames are a representation projected on a flat surface. This information is to not be taken into account when superimposed on a vertical object or an object on the ground.

Objects which appear on the edge of the screen may be deformed.

In very bright light (snow, vehicle in sunshine, etc.), the camera vision may be adversely affected.

### Deactivating the system

The system may be deactivated:

- when the vehicle is travelling faster than about 7 mph (12 km/h);
- shortly after disengaging reverse gear.

### Operating faults

When reverse gear is engaged, if the system detects an operating fault, a black screen is displayed temporarily on the multimedia screen **2**.

This may be caused by a fault affecting the camera or screen (clearness, fixed image, delayed communication etc.).

If the temporary display of the black screen persists, please consult an approved dealer.



This function is an additional aid. It cannot, therefore, under any circumstances replace the vigilance or the responsibility of the driver.

The driver should always pay attention to sudden incidents during driving : always ensure that there are no moving obstacles (such as a child, animal, pram, bicycle, etc.) or small, narrow objects such as stones or posts in your path when manoeuvring.

## PARKING AIDS

Difference between the estimated distance and actual distance

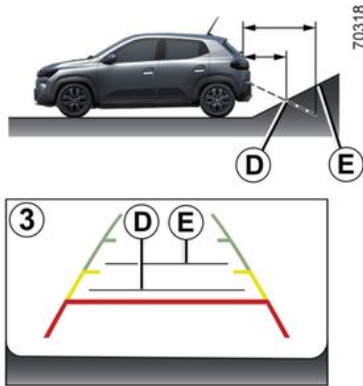

### Driving or reversing towards a steep uphill slope

The fixed guidelines **3** show the distances as closer than they actually are. The objects shown on the screen are actually further away on the slope. For example, if the screen displays an object at **D**, the actual distance of the object is at **E**.

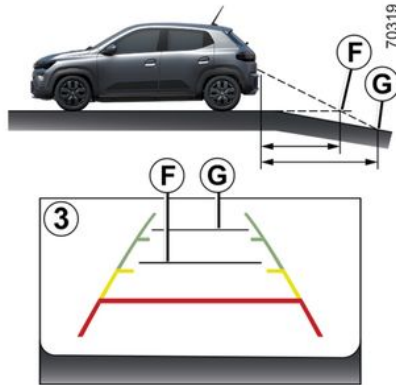

### Driving or reversing towards a steep downhill slope

The fixed guidelines **3** show the distances as further than they actually are.

Therefore, the objects shown on the screen are actually closer on the slope.

For example, if the screen displays an object at **G**, the actual distance of the object is at **F**.

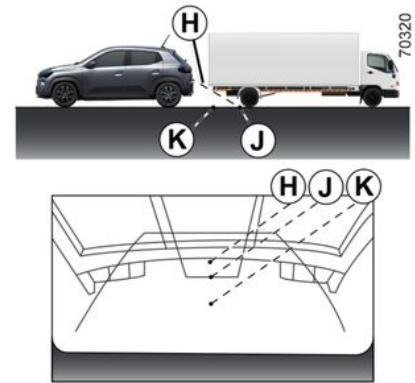

### Driving or reversing towards a protruding object

Position **H** seems further than position **J** on the screen. However, position **H** is at the same distance as position **K**.

The trajectory indicated by the fixed and mobile guidelines do not take into account the height of the object. So there is a risk that the vehicle may collide with the object when reversing towards position **K**.

## EMERGENCY CALL

If the vehicle is equipped, the emergency call function can be used to call the emergency services (without charge) automatically or manually in the event of an accident or illness, reducing the time it takes for the emergency services to arrive.

**Note** : the emergency call operates

- in countries covered by the associated telematics emergency services and infrastructure compatible with the system.

- depending on the coverage in the geographical region where the vehicle is being driven.

If you use the emergency call function to report an accident which you have witnessed, this implies stopping where traffic conditions allow in order for the emergency services to locate your vehicle and therefore the location of the reported accident.

In all cases, comply with local legislation.

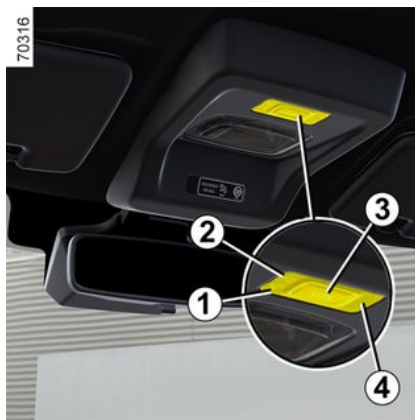

### 1. System operation warning light:

- green : operational (network available) ;
- off : non-operational (network unavailable) ;
- red : operating fault ;
- green flashing : call in progress.

### 2. Automatic mode warning light ;

### 3. SOS button ;

### 4. Microphone ;

### 5. Speaker.

 Use the emergency call only in the event of an emergency you are involved in, if you witness an accident or if you feel ill.



A call is always made as follows:

- the call is set up with the emergency services;
- send data related to the incident (vehicle identification plate, local time of the call, last positions, direction of the vehicle);
- voice communication with the emergency services;

## EMERGENCY CALL

– if necessary, emergency assistance is called.

Emergency call has two modes:

- automatic mode;
- Manual mode.

### Automatic mode

If the automatic mode **2** warning light appears in green this confirms that the automatic system is activated.

The emergency call starts automatically in the event of an accident that has required the activation of the protective equipment (seat belt pretensioners, airbag etc.).



In the event of an accident, if the location and traffic conditions permit, stay close to the vehicle in order to be able answer the call centre quickly if necessary.

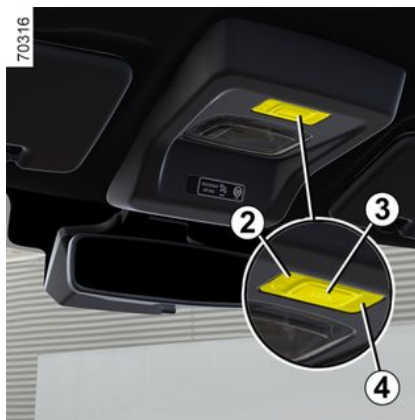

### Manual mode

The emergency call is carried out by:

- pressing and holding the **3** button for at least three seconds;
- or
- pressing the button **3** five times within ten seconds.

In the event of unintended operation, it is possible to cancel the call by pressing the **3** button for around two seconds, before the call is connected to the call centre.

Once a call is established, only the call centre can end the call.

### Operating faults

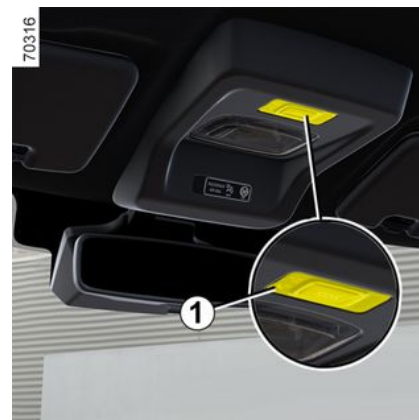

In some cases, the emergency call may not work (e.g. low battery).

When the system detects an operating fault, the **1** warning light turns red for over 30 minutes; consult an Approved Dealer as soon as possible.



The system operates with a dedicated battery. The battery service life is approximately four years (the **1** warning light lights up in red to warn you when approaching expiry). Consult an approved dealer

## EMERGENCY CALL



To guarantee your safety and the proper operation of the system, any operation carried out on the battery (removal, disconnection, etc.) must be carried out by a qualified specialist.

**Risk of serious burns or electric shocks.**

You must respect the replacement intervals (without exceeding them) as stated in the maintenance document.

The battery is a specific type.

Please ensure it is replaced with the same type.

Call an approved Dealer.



Without the emergency call feature, the system is not trackable and will not be under constant surveillance. Data is automatically and constantly erased, and the system stores only the last three positions of the vehicle.

According to local legislation, data is only sent in the event of an emergency call. Data sent to the call centre is treated according to the personal data protection laws applicable in the country where you are located. The system stores activity history data for 13 hours only.

The vehicle owner has the right of access to their data. They can request that the data be corrected, deleted or locked.

# AIR VENTS, HEATING AND AIR CONDITIONING

## Air vents: air outlets

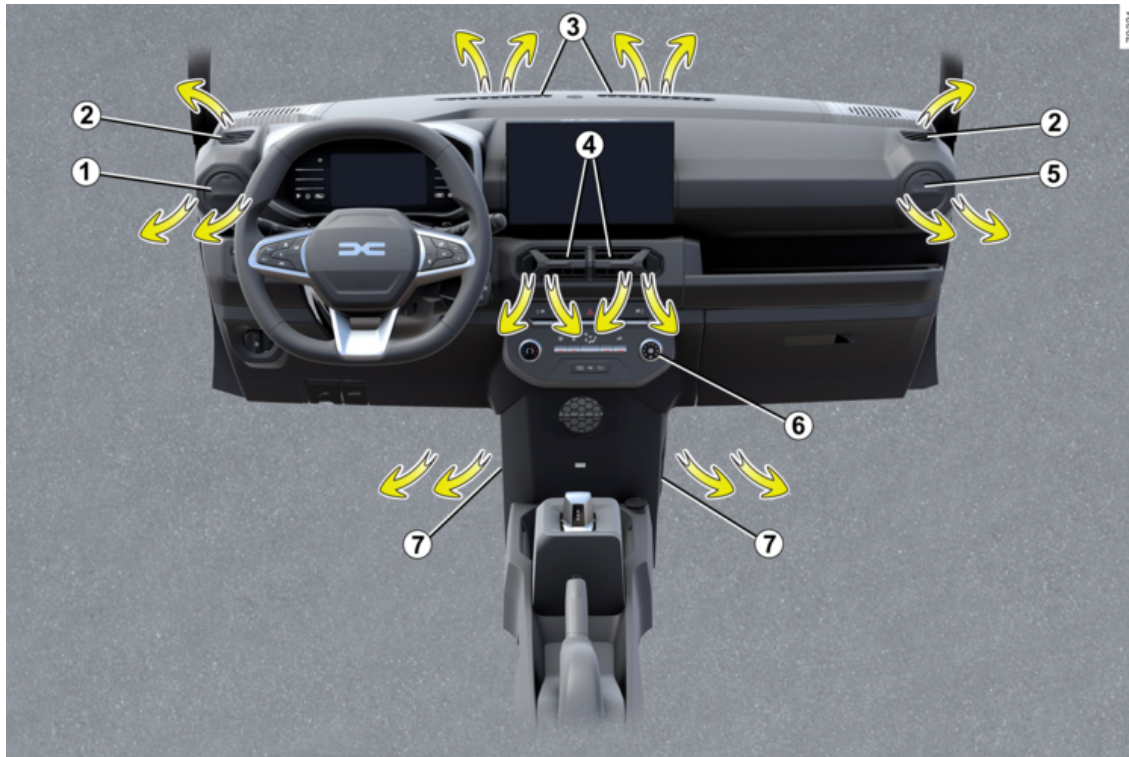

# AIR VENTS, HEATING AND AIR CONDITIONING

- 1 Left-hand side air vent;
- 2 Side demisting vent;
- 3 Windscreen demisting vent;
- 4 Centre air vent;
- 5 Right-hand side air vent;
- 6 Control panel;
- 7 Footwell heater outlets for front passengers.

## Side air vents

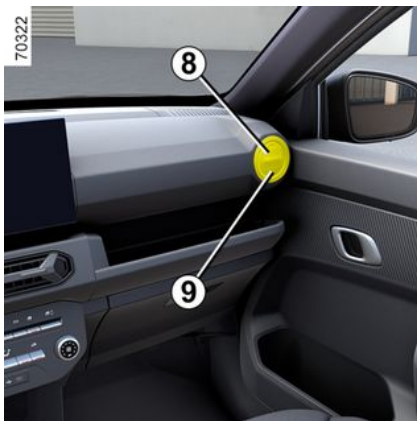

To open, press the ventilation outlet **8** until it opens as far as required.  
To close, press the ventilation outlet **9** until it closes.

To change the airflow direction, turn the ventilation outlet to the desired position

## Centre air vents



To adjust the airflow, move slide **10** or **11** up, down and sideways, until it opens as far as desired

To close, move slide **10** all the way to the left and slide **11** all the way to the right.

To remove bad odours from your vehicles, only use the systems designed for this purpose. Consult an authorised dealer.



Do not add anything to the vehicle's ventilation circuit (for example, to remove bad odours).

**There is a risk of damage or of fire.**

## Heating, ventilation, air conditioning

### Controls



The controls will depend on the vehicle equipment level.

1. Air temperature adjuster.
2. Rear defogger switch.

## AIR VENTS, HEATING AND AIR CONDITIONING

3. Max defrost.
4. Distribution of air.
5. Switching air conditioning on or off. (depending on the vehicle)
6. Switching passenger compartment to isolation mode / air recirculation mode.
7. Adjusting the ventilation fan speed.

**Information and advice on use** : refer to information on → 195.

### Adjusting the air temperature

Turn control **1** to obtain the desired temperature. The further towards the red the side is, the higher the temperature will be.

### Adjusting the ventilation fan speed.

Turn control **7** from OFF to 8. The further to the right it is positioned, the more air is blown into the passenger compartment. If you want to stop the system, set control **7** to **OFF**.

The system is deactivated: the ventilation speed for the passenger compartment air is zero (vehicle stationary), you can however still feel a slight flow of air when the vehicle is moving.



Leaving this control in position **OFF** for prolonged periods can lead to condensation forming on the side windows and windscreen and problems due to the use of non-renewed air in the passenger compartment.

### Switching passenger compartment isolation mode/ air recirculation mode on

Press button **6** to activate air recirculation mode : the button's warning light comes on.

Under these conditions, air is taken from the passenger compartment and is recirculated, with no air being taken from outside the vehicle.

#### **Air recirculation is used to :**

- to isolate the passenger compartment from the external atmosphere (eg. driving in polluted areas, ets.) ;
- depending the vehicle, to cool the passenger compartment to the desired temperature as quickly as possible, when air conditioning is activated (see following page).

**To exit this mode, press button 6 :** the button warning light goes off.

### Switching passenger compartment to fresh air mode

Fresh air mode is the normal operation (outside air) when the air recirculation mode is deactivated.

If necessary, press button **6** to deactivate air recirculation mode : the button's warning light comes off.

**The fresh air mode is activated.**



Prolonged use of air recirculation can lead to condensation forming on the side windows and windscreen and discomfort due to the use of non-renewed air in the passenger compartment. You are therefore advised to return to fresh air mode (outside air) as soon as the air recirculation function is no longer required, by pressing button 6 again. The warning light goes off.

### Rear screen deicing / demisting



**With the engine running,** press button **2**.

This function de-ices/demists the rear screen.

# AIR VENTS, HEATING AND AIR CONDITIONING

The function is stopped :

- automatically after a period of time set by the system ;
- by pressing button **2** again.

## Rapid demisting



**4** With the engine running, press button **3**.

This function de-ices/demists the front and Rear screen.

## Distribution of air in the passenger compartment

Turn control **5** to choose the distribution option.



The airflow is coming from the dashboard vents



The airflow is coming from the dashboard vents and directed to the footwells



The air flow is directed mainly towards the footwells



The air flow is distributed between all the air vents, the windscreen demisting air vents and the footwells.



The air is directed to the windscreen.

## Switching air conditioning ON or OFF

(Depending on the vehicle).

The air conditioning is switched on (indicator light illuminated) or off (indicator light extinguished) using button **5**.

Activation is not possible if control **7** is set to **OFF**.

**The air conditioning system is used for :**

- lower the temperature inside the passenger compartment ;
- eliminate condensation more quickly.

The air conditioning does not operate when the exterior temperature is very low.

## Air conditioning: programming

### Air conditioning programming



With the vehicle stationary and the engine on, select « Electric » from the « Vehicle » world on the multimedia screen **1**, then select « Charging & Air conditioning » tab to access the settings.

You can save several comfort programmes by activating the following settings:

- programming the time by which the vehicle must be ready;
- selecting days when the programme must be repeated. You can activate/deactivate the saved programmes.

## AIR VENTS, HEATING AND AIR CONDITIONING



you can programme the air conditioning using a smart-phone application.

Please refer to the multimedia instructions for further information.

The warning light  is displayed on the instrument panel.



### Driver's responsibility when parking or stopping the vehicle

Never leave an animal, child or

adult who is not self-sufficient alone in your vehicle, even for a short time. In hot and/or sunny weather, please remember that the temperature inside the passenger compartment increases very quickly. **RISK OF DEATH OR SERIOUS INJURY.**

### Immediate activation of the air-conditioning

The operation of the immediate activation of the air-conditioning is different from programming:

- it must be launched from your smart-phone;
- the heated steering wheel and seats function, if your vehicle is equipped, is activated automatically;
- the function stops after approximately 10 minutes.

Please refer to the multimedia instructions for further information.

### Pre-conditioning activation is possible only if:

- the bonnet is closed;
- the traction battery charge level is over 5%;
- the engine is stopped;
- the driver is not in the vehicle.

### Stopping the programmed air conditioning

The air conditioning stops automatically around ten minutes after the set end time. However, the function can be deactivated if:

- the engine is started;
- the traction battery charging level is lower than 5%;
- the bonnet is open;
- you press one of the switches on the control panel;
- the driver is in the passenger compartment for approximately 20 seconds.



these conditions are also applicable for the immediate deactivation of the air conditioning.

If the vehicle is parked for a long time without opening a door with at least one active pre-conditioning schedule, then the function will be deactivated from the third pre-conditioning launch included. The function will be available when one of the doors of the vehicle is opened.

## Air conditioning: information and advice on use

### Advice on use

In some situations, (air conditioning off, air recirculation activated, ventilation speed at zero or low, etc.) you may notice that condensation starts to form on the windows and windscreen.

If there is condensation, use the « **Rapid demisting** » function to remove it.

# AIR VENTS, HEATING AND AIR CONDITIONING

## Maintenance

Refer to the Maintenance Document for your vehicle for the inspection frequency.

## Range

It is normal to notice an increase in energy usage when the air conditioning or heating is operating.

## Recommendations to limit energy consumption and maintain the vehicle range

Drive with the air vents open and the windows closed. If the vehicle has been parked in the sun, open the doors for a few moments to let the hot air escape before starting the engine.

**It is preferable** before setting off, to use pre-conditioning when the vehicle is plugged to charging station. (please refer to the information on Heating, ventilation and air conditioning)

## Operating faults

As a general rule, contact your approved dealer in the event of an operating fault.

– **Reduction in de-icing, demisting or air conditioning performance.** This may be caused by the passenger com-

partment filter cartridge becoming clogged.

– **No hot or cold air is being produced.** Check that the controls are set correctly and that the fuses are sound. Otherwise, switch off the system.

## Presence of water under the vehicle.

After prolonged use of the air conditioning system, it is normal for water to be present under the vehicle. This is caused by condensation.



**Do not open the refrigerant fluid circuit.** The fluid may damage eyes or skin.

## Refrigerant fluid



The refrigerant fluid circuit (of which some components are hermetically sealed) may contain fluorinated greenhouse gases.

Depending on the vehicle, you will find the following information on label **A** affixed inside the engine compartment.

The presence and location of the information on label **A** depends on the vehicle.



**Type of refrigerant fluid**



**(XXX) Type of oil in the air conditioning circuit**

# AIR VENTS, HEATING AND AIR CONDITIONING

 **Inflammable product**

 **Consult the vehicle user manual**

 **Maintenance**

x.xxx kg	(1) Quantity of refrigerant fluid present in the vehicle.
GWP xxxxx	(2) Global Warming Potential (CO2 equivalent).
CO2 eq x.xxxt	(3) Quantity in weight and in CO2 equivalent.

## Additional information

Depending on label and depending on the type of refrigerant:

### Refrigerant fluid R-1234yf

- (1) 0.385 kg
- (2) GWP 0.501
- (3) 0.00019 t



**Do not open the refrigerant circuit.** The fluid may damage eyes or skin.



Before carrying out any action in the engine compartment, you must switch off the ignition

→ 127.

## Multimedia equipment

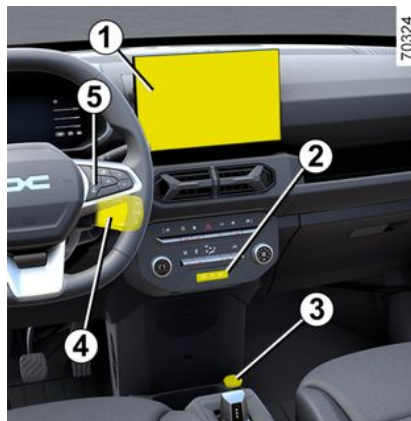

The presence and location of this equipment depends on the vehicle version.

1. Multimedia screen.
2. USB-C multimedia ports in the centre console.
3. Accessories socket.
4. Steering column control.
5. Voice command.
6. Microphone.



## Using the telephone

We remind you of the need to conform to the legislation in force concerning the use of such equipment.

## Multimedia port 2

The sockets USB can also be used to charge accessories with a maximum power of 12 Watts (5 V) per socket.

**Note:** the multimedia USB 2 ports also allow for data transfer.

## AIR VENTS, HEATING AND AIR CONDITIONING



Please refer to the multimedia instructions for further information.



Connect accessories with a maximum power of 12 watts only.  
**Fire hazard.**



**Using the telephone**  
We remind you of the need to conform to the legislation in force concerning the use of such equipment.



For safety reasons, carry out any adjustments while the vehicle is stationary.

### Hands-free telephone integrated control



Use the microphone **6** and the steering column control **4**.

### Phone holder



On vehicles that are equipped, lift the flap **7**, place your phone **10** horizontally onto the stand **8** then lower the flap **7** while keeping the phone in position on the stand **9**.



Make sure that the phone is securely held in place between the stands **8** and **9** before use.

## AIR VENTS, HEATING AND AIR CONDITIONING



Make sure that the telephone is securely held in place in the telephone holder to ensure that it is not thrown onto the occupants during sudden turning or braking.



### **Using the telephone**

We remind you of the need to conform to the legislation in force concerning the use of such equipment.

# PASSENGER COMPARTMENT EQUIPMENT

## Electric windows



Press the bottom of switch **1** or **2** to open the window or press the top of switch **1** or **2** to close it to the desired level.

- 1.** for the front driver side ;
- 2.** for the front passenger side.

## From driver side 3



For driver to prevent operation of rear electric windows

 Avoid resting any objects against a half-open window : there is a risk that the electric window could be damaged.

## From the rear seats

### Rear electric windows



Operate switch **4** to raise or lower the rear windows.

### Manually operated rear windows



## PASSENGER COMPARTMENT EQUIPMENT

Turn the handle **5** to lower or raise the window to the desired height.

### Manually operated rear windows (Utility version)



Depending on the vehicle, turn the rotary control **6** in anti-clockwise direction to lower or in clockwise direction to raise the window to desired height.

**NOTE:** when closing the window, apply additional force to the door rotary control **6** at the end of the window travel to ensure complete closure.



When closing the windows, ensure that no part of the body (arm, hand, etc.) is protruding from the vehicle.

**Risk of serious injury.**



### Driver's responsibility

Never leave your vehicle with the key or remote control in it, leaving a child, adult who is not self-sufficient or a pet inside, even for a short while. They may pose a risk to themselves or to others by starting the engine or activating equipment (such as the gear selector or electric windows). If any part of the body becomes trapped, reverse the direction of the window immediately by pressing the relevant switch.

**Risk of serious injury.**

## Interior lighting

### Front map light

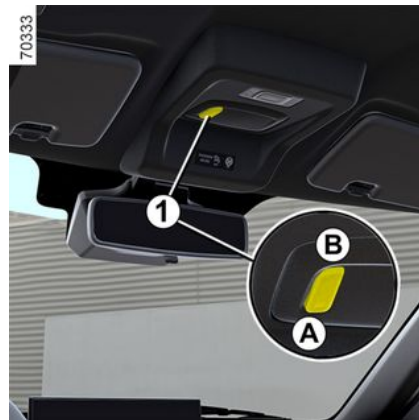

**This feature depends on the vehicle version.**

Press switch **1** to enable:

- position **A** for switching **ON** the light;
- position **B** for switching **OFF** the light.

## PASSENGER COMPARTMENT EQUIPMENT

### Front Courtesy light

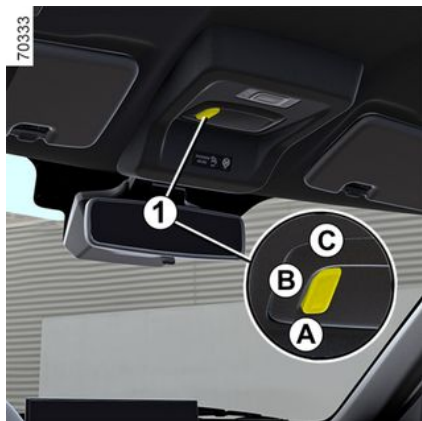

**This feature depends on the vehicle version.**

Press switch **1** to enable:

- position **A** for switching **ON** the light;
- position **B** for **auto - ON** lighting, which activates when any of the door is opened and switches off when all doors have been closed correctly;
- position **C** for switching **OFF** the light.

### Sun visor

#### Front sun visor



**This feature depends on the vehicle version.**

Lower the sun visor **1** over the windshield or unclip it and turn it over the side window.

### Accessories socket, ashtray, cigarette lighter

#### Accessories socket 1



It is provided for connecting accessories approved by our Technical Department.

## PASSENGER COMPARTMENT EQUIPMENT



Connect accessories with a maximum power of 120 watts (12 V) only.

When several accessory sockets are used at the same time, the total power of the connected accessories must not exceed 180 watts.

**Fire hazard.**

# PASSENGER COMPARTMENT STORAGE, FITTINGS

## Glove Box 1



Pull handle **1** to open glove box.  
It can hold A4 size documents, a large bottle of water, etc.

## Glove Box 2



It is an additional storage to store small things



Do not store any object inside which can harm - sharp / spillable, etc

## Centre console storage 3



Can be used to hold motorway toll tickets, maps, etc.



Nothing should be placed on the floor area in front of the driver as such objects may slide under the pedals during braking manoeuvres, thus obstructing its use.

# PASSENGER COMPARTMENT STORAGE, FITTINGS

## Front door storage 4



## Front seat back storage 5

(Depending on the vehicle)

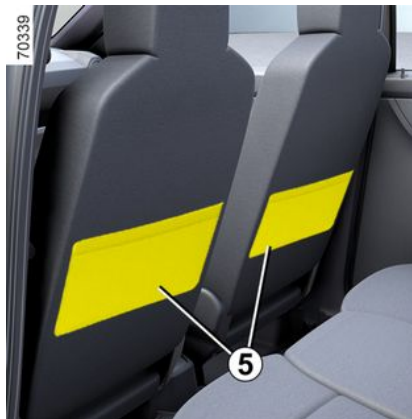

Ensure that no hard, heavy or pointed objects are placed in the « open » storage compartments in such a way that they may fall onto passengers during sudden turning, braking or in the event of an accident.

# TRANSPORTING OBJECTS

## Luggage compartment storage

### Rear parcel shelf



The parcel shelf **2** automatically lifts when the luggage compartment is opened.

#### Removal

- unhook the two straps **1** ;
- lift up along the direction **A** and gently pull towards you.

#### Refitting

To refit the parcel shelf, proceed in the reverse order to removal



Do not place any heavy or solid objects on the luggage cover. These may pose a risk to the vehicle occupants if the driver has to brake suddenly or if the vehicle is involved in an accident.

### Transporting objects in the luggage compartment

Always position the objects transported so that the largest surface is against :

- the rear bench seatback, for normal loads (example **A**).
- the front seatbacks with the rear seatbacks folded down, as is the case for maximum loads (example **B**).

If you have to place objects on the folded seatback, it is necessary that you lower the headrests before folding the seatback so that it can be folded as flat as possible against the seat.



## TRANSPORTING OBJECTS



The luggage should be loaded in such a way that no items will be thrown forward and strike the occupants if the driver has to brake suddenly. Fasten the rear seat belts, even if the seats are not occupied.

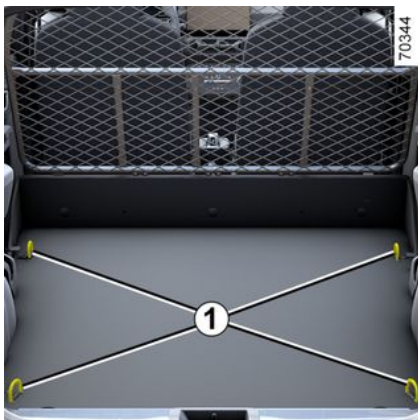

### Transporting objects in the rear load area

Depending on the vehicle, the rotary rings **1** are used to retain objects in transit. The number of rings and their position may vary depending on the vehicle.



The sole purpose of these rings is to prevent transported objects from moving. The objects must be secured to the mounting rings **1** on the vehicle floor beforehand.

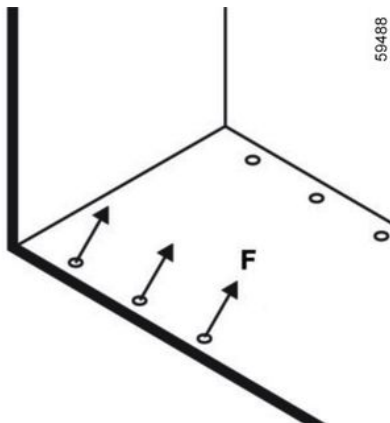

### Special note for 2 seater version

Rotary rings **1**

**F max : 300daN**



For your safety, check that all the vehicle's doors are properly closed before starting the engine.

## Luggage net

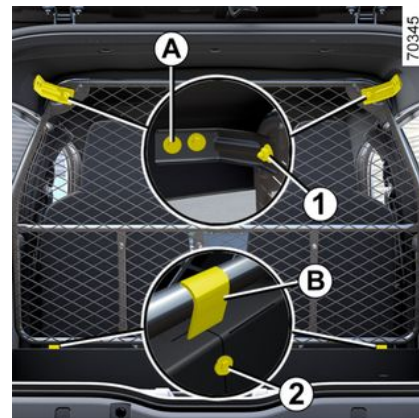

On equipped vehicles, the luggage net can be used, when transporting animals or luggage, to separate them from the passenger section.

It is fitted behind the driver and passenger seats.

## TRANSPORTING OBJECTS

### Fitting the luggage net behind the front seats

Inside the vehicle on each upper side :

- align the holes in the net to the holes in the bracket **A** on the upper left side/ right side ;
- tighten the bolts **1** to fit the net to the vehicle.

4

Inside the vehicle on each lower side :

- align the holes in the bracket **B** to the holes in the carpet on the lower left side/right side ;
- tighten the bolts **2** to fit the net to the vehicle.



The luggage net must not be used to restrain or hold objects.

**Risk of injury.**

# ACCESSING THE ENGINE, LEVELS

## Bonnet



To open the bonnet, pull the knob **1**.



(Depending on the vehicle)

### Unlocking the bonnet latch

To unlock, gently lift the bonnet and push tab **2** towards left to release the striker **4**.

### Opening the bonnet

Lift the bonnet ; remove the Stay rod **3** from lock clip and place into the hole to hold the bonnet open.

### Closing the bonnet



To close the bonnet, remove the Stay rod **3** from the hole and place to the lock clip. Lower it to 30 cm above the closed position, then release it. It will

lock automatically under its own weight.

 It is recommended not to lower the bonnet more than 30 cm above its closed position to avoid damage to the headlamps or front face of your vehicle.

 Do not open the bonnet when the vehicle is charging or when the ignition is switched on.

 Do not press down on the bonnet : there is a risk that the bonnet will close inadvertently.

5

## ACCESSING THE ENGINE, LEVELS



In the event of even a slight impact involving the radiator grille or bonnet, have the bonnet lock checked by an authorised dealer as soon as possible.



When working in the engine compartment, ensure that the windscreen wiper stalk is in the park position.  
**Risk of injury.**



The vehicle drive system in an electric vehicle uses a direct voltage of approximately « 260 V ».

This system can get hot during and after switching off the ignition. Respect warning messages given on the labels in the vehicle.

Any intervention or modification on the vehicle's « 260 V » electrical system (components, cables, connectors, traction battery) is strictly prohibited.

**Risk of serious injury and/or electric shock which may endanger life.**

The engine cooling fan may also

start at any moment. The  label in the engine compartment reminds you of this.

**Risk of injury.**



After carrying out any work in the engine compartment, check that nothing has been left behind (cloth, tools etc.). Otherwise, this may lead to engine damage.



Ensure that the bonnet is properly locked. Ensure that nothing is preventing locking (grit, cloths, etc.).



The engine may be hot during operations in close proximity. In addition, the engine cooling fan may come on at any moment.  
**Risk of injury.**



# ACCESSING THE ENGINE, LEVELS

## Coolant level



Check the level on flat ground, with the engine switched off. **When cold**, the level must be between the « MINI » and « MAXI » marks on the reservoir **1**.

Top this level up **when cold** before the « MINI » mark is reached.



Do not carry out any work under the bonnet while the vehicle is charging or while the ignition is switched on.

## Frequency of checking coolant level

**Check the coolant level regularly** (very severe damage is likely to be caused to the engine if it runs out of coolant).

If the level needs to be topped up, only use products approved by our Technical Department which ensure :

- protection against freezing ;
- anticorrosion protection of the cooling system.



Consult your approved dealer at once if you notice an abnormal or repeated drop in any of the fluid levels.



When working in the engine compartment, ensure that the windscreen wiper stalk is in the park position.

**Risk of injury.**

## Replacement intervals

Refer to the Maintenance Schedule for your vehicle.



No operations should be carried out on the cooling circuit when the engine is hot.

**Risk of burns.**



Before carrying out any action in the engine compartment, you must switch off the engine

→ 127.

## ACCESSING THE ENGINE, LEVELS

### Levels, filters

#### Brake fluid level



The level should be read with the engine switched off and on level ground.

This should be checked frequently, and immediately if you notice even the slightest loss in braking efficiency.

#### Replacement interval

Refer to the Maintenance Document for your vehicle.

#### Level 2

It is normal for the level to drop as the brake shoes become worn, but it must never drop lower than the « MINI » warning line.

If you wish to check the disc and drum wear yourself, you should obtain the document explaining the checking procedure from the network or the manufacturer's web site.

#### Topping up

After any operation on the hydraulic circuit, a specialist must replace the brake fluid.

Only use fluids approved by our Technical Department (and taken from a sealed container).



If there is an abnormal or repeated drop in the fluid level, please consult an authorised dealer.

#### Windscreen washer reservoir



#### Topping up

Engine switched off :

- open the cap **2** ;
- pull the extending funnel upwards as far as it will go ;
- fill until you can see the fluid ;
- push the funnel by pressing on it and replace the cap.

#### Liquid

Only use windscreen washer fluid containing antifreeze.

We advise you to consult an approved dealer or a qualified professional.

**Note:** do not use hard water (risk of damage to the priming pump or

## ACCESSING THE ENGINE, LEVELS

limescale building up on the pump and the jets).

### Jets

To adjust the height of the windscreen washer jets, please consult an authorised dealer.

### Filters

The filter elements (cabin filter etc.) should be replaced during the maintenance operations carried out on your vehicle.

**Replacement intervals for filter elements** : refer to the Maintenance Document for your vehicle.



When working in the engine compartment, ensure that the windscreen wiper stalk is in the park position.

**Risk of injury.**



Before carrying out any action in the engine compartment, you must switch off the ignition.



No operations should be carried out on the cooling circuit when the engine is hot.

**Risk of burns.**



When working under the bonnet, the bonnet may be hot. The engine cooling fan may also start at any moment.

**Risk of injury.**

# BATTERY

## Secondary 12 V battery



The secondary battery is a 12V battery :this supplies the energy required to operate vehicle equipment (lights, windscreen wipers, audio system, etc) and certain safety systems, such as ABS.

**You should not open it or add any fluid.**

### Maintenance/replacement

The charge status of the 12 volt battery **1** can decrease, especially if you use your vehicle:

- when the outside temperature drops;

- after extended use of energy-consuming devices with the engine switched off.



Handle the battery with care as it contains sulphuric acid which must not come into contact with the eyes or skin. If it does, wash the affected area with plenty of cold water. If necessary, consult a doctor. Ensure that naked flames, red hot objects and sparks do not come into contact with the battery as there is a risk of explosion.



Do not carry out any work under the bonnet while the vehicle is charging or while the ignition is switched on.



Depending on the vehicle, in the event of a battery fault (disconnected, discharged battery, etc.), a reset of the steering wheel angle must be carried out → **118**.



For your own safety and for the proper operation of the vehicle's electrical equipment (lights, windscreen wipers, ABS, etc.), any intervention on the secondary 12 V battery (removal, disconnection, etc.) must **categorically** be performed by a specialist professional.

Risk of serious burns or electric shocks.

Respect **categorically** the replacement intervals (without exceeding them) as stated in the maintenance document.

The battery is a specific type. Please ensure it is replaced with the same type.

Contact an Authorised Dealer.

# BATTERY



## Label A

Observe the indications on the battery  
2. naked flames and smoking are forbidden;

- 3. eye protection required;
- 4. keep away from children;
- 5. explosive materials;
- 6. please consult the vehicle user manual;
- 7. corrosive materials.

 To avoid damaging your vehicle, do not recharge the secondary 12 V battery using:

- an external battery charger;
- a battery from another vehicle.

Please contact an authorised dealer.

 Do not disconnect the secondary 12 V battery.  
**Risk of serious burns or electric shocks.**

 Do not use your electric vehicle to restart the 12 volt battery in another vehicle. The 12 volt electric power of an electric vehicle is not enough to perform such an operation. Risk of damage to the vehicle.



When working under the bonnet, the bonnet may be hot. The engine cooling fan may also start at any moment.  
**Risk of injury.**

# CLEANING

## Bodywork maintenance

A well-maintained vehicle will last longer. It is therefore recommended to maintain the exterior of the vehicle regularly.

Your vehicle has been treated with very effective anti-corrosion products. It is nevertheless subject to various outside influences.

### Corrosive agents in the atmosphere

- atmospheric pollution (built-up and industrial areas) ;
- saline atmospheres (near the sea, particularly in hot weather) ;
- seasonal and damp weather conditions (e.g. road salt in winter, water from road cleaners, etc.).

### Minor impacts

#### Abrasive action

Dust and sand in the air, mud, road grit thrown up by other vehicles, etc.

You should take a number of minor precautions in order to safeguard your vehicle against such risks.

### You should do the following

Wash your car frequently, **with the engine off**, with cleaning products recommended by the manufacturer (never use abrasive products). Rinse thoroughly beforehand using a jet washer:

- spots of tree resin and industrial pollution;
- mud in the wheel arches and underneath the body which forms damp patches;
- **bird droppings, which cause a chemical reaction with the paint that rapidly discolours paintwork and may even cause the paint to peel off;**

Wash the vehicle **immediately** to remove these marks as it is impossible to remove them by polishing;

- salt, particularly in the wheel arches and underneath the body after driving in areas where the roads have been gritted.

Remove any plant matter (resin, leaves, etc.) from the vehicle regularly.

Observe local regulations about washing vehicles (e.g. do not wash your vehicle on a public highway).

Observe the vehicle stopping distances when driving on gravelled surfaces to prevent paint damage.

Repair, or have repaired quickly, areas where the paint has been damaged, to prevent corrosion spreading.

Remember to visit the body shop periodically in order to maintain your anti-corrosion warranty. Refer to the Maintenance Document.

When washing the vehicle with a high-pressure cleaning device, please take the following precautions:

If it is necessary to clean mechanical components, hinges, etc., spray them with products approved by our Technical Department to protect them after they have been cleaned.

- make sure that your vehicle's paintwork, the area or the component that you want to clean is compatible with this type of washing;
- the pressure delivered by the device must be less than 100 bar;
- when washing, position the spray nozzle at least 15 cm from the vehicle and check that the water flow rate is less than 3.30 gal (15 l)/min;
- do not persist in washing the same area, impacted points or the seals (risk of damage to the paint, seals becoming detached, etc.).

If mechanical components, hinges, etc. have been cleaned, they must be protected again by spraying with products approved by our Technical Department.

## CLEANING



We have selected special products to care for your vehicle and you can obtain these from the manufacturer's accessory outlets.

### What you should not do

Wash the vehicle in bright sunlight or freezing temperatures.

Do not scrape off mud or dirt without pre-wetting.

Allow dirt to accumulate on the exterior.

Allow rust to form following minor impacts.

Do not use solvents not approved by our Technical Department to remove stains as this could damage the paintwork.

Do not drive in snow or muddy conditions without washing the vehicle, particularly under the wheel arches and body.



Degrease or clean using high-pressure cleaning equipment or by spraying on products not approved by our Technical Department :

- –mechanical components (e.g. : engine compartment) ;
- the wheels (e.g. braking system components such as brake callipers) ;
- –the under body (location of the 260 Volt traction battery) ;
- –parts with hinges (e.g. : inside the doors) ;
- –charging flap ;
- –the painted plastic external fittings (e.g. : bumpers).

Doing this could give rise to corrosion or operational faults.

### Vehicles with a matte paint finish

This type of paint requires certain precautions.

#### You should do the following

Wash the vehicle by hand using plenty of water, using a soft cloth or a gentle sponge.

#### Do not do the following

Use wax-based products (polishing).

Rub too hard.

Wash the vehicle in a roller-type car wash.

Attach stickers to the paintwork (risk of leaving marks).



Wash the vehicle using a high-pressure cleaning device.

### Using a roller type car wash

Return the wiper stalk to the park position. Check the mounting of external accessories, additional lights and rear view mirrors, and ensure that the wiper blades are secured with adhesive tape.

Remove the radio aerial mast if your vehicle is fitted with this equipment.

Remember to remove the tape and re-fit the antenna after washing.



#### Washing the vehicle

Never wash the engine compartment, the charging connection or the traction battery with a high-pressure jet.

**This risks damaging the electric circuit.**

Never wash the vehicle while it is charging.

**Risk of electric shock and a risk to life.**

## CLEANING

### Cleaning the headlights, sensors and cameras

Use a soft cloth or cotton wool. If this does not clean them properly, moisten the cloth with soapy water, then wipe clean with a soft damp cloth or cotton wool.

Finally, carefully dry off with a soft dry cloth.

**Do not use cleaning products containing alcohol or utensils (e.g. : a scraper).**

### Interior trim maintenance

A well-maintained vehicle will last longer. It is therefore recommended to maintain the interior of the vehicle regularly.

A stain should always be dealt with swiftly.

Whatever type of stain is on the trim, use **cold (or warm) soapy water with natural soap.**

**Detergents (washing-up liquid, powdered products, alcohol-based products) should not be used.**

Use a soft cloth.

Rinse and soak up the excess water.

### instrument panel

(e.g. instrument panel, clock, exterior temperature display, radio display, etc.)

Use a soft cloth (or cotton wool).

#### Caution :

No liquid cleaning agents and water should be used to clean the Instrument panel.

It is recommended to use only soft and dry cloth to clean the instrument panel as there is no glass screen on the same.

**Cleaning products containing alcohol must not be used under any circumstances.**

### Seat belts

These must be kept clean.

Use products selected by our Technical Department (approved outlets) or warm, soapy water and a sponge and wipe with a dry cloth.

**Detergents or dyes must not be used under any circumstances.**

### Textiles (seats, door trim, etc)

Vacuum-clean the textiles **regularly.**

#### Liquid stain

Use soapy water.

Dab lightly (never rub) with a soft cloth, rinse and remove the excess.

### Solid or pasty stain

Carefully remove the excess solid or pasty material **immediately** with a spatula (working from the edges to the centre to avoid spreading the stain).

Clean in a similar way as a liquid stain.

#### Special instructions for sweets or chewing gum

Put an ice cube on the stain to solidify it, then proceed as for a solid stain.



For further recommendations for maintaining the interior, and/or for any unsatisfactory results, please see an authorised dealer.

### Removal/replacing removable equipment originally fitted in the vehicle

If you need to remove equipment in order to clean the passenger compartment (for example, mats), always ensure that they are correctly refitted and they are at correct position. (The driver's mat should be fitted on the driver's side, etc.) and fit them with the components supplied with the equipment (for example, the driver mat should always be fixed using the pre-fitted mounting components).

## CLEANING

With the vehicle stationary, ensure that nothing will impede driving (anything obstructing the pedals, heel wedged by the mat, etc.).

### **You should not :**

You are strongly advised not to position objects such as deodorants, scents, etc. near air vents, as this could damage your dashboard trim.



You are strongly recommended not to use high pressure or spray cleaning equipment inside the passenger compartment : use of such equipment could impair the correct functioning of the electrical or electronic components in the vehicle, or have other detrimental effects.

# TYRES

## Tyres

The tyres are the only contact between the vehicle and the road, so it is essential to keep them in good condition. You must make sure that your tyres conform to local road traffic regulations.

## Maintaining the tyres



The tyres must be in good condition and the tread form must have sufficient depth ; tyres approved by our Technical Department have tread wear indicators **1** which are **indicators moulded into the tread at several points**.

When the tyre tread has been worn to the level of the wear indicators, **they become visible 2: it is then necessary to replace your tyres because the tread rubber is no more than 1.6 mm deep, resulting in poor road-holding on wet roads.**

An overloaded vehicle, long journeys by motorway, particularly in very hot weather, or continual driving on poorly surfaced minor roads will lead to more rapid tyre wear and affect safety.



Incidents which occur when driving, such as striking the kerb, may damage the tyres and wheel rims, and could also lead to misalignment of the front or rear axle geometry. In this case, have the condition of these checked by an approved dealer.

## Tyre pressures

Adhere to the tyre pressures, the tyre pressures should be checked at least once a month and additionally before any long journey (refer to the label affixed on the driver side. → 222

Pressures should be checked when the tyres are cold: ignore higher pres-

ures which may be reached in hot weather or after the vehicle is driven at high speed.



**Incorrect tyre pressures** lead to abnormal tyre wear and unusually hot running. These are factors which may seriously affect safety and lead to:

- poor road holding.
- risk of bursting or tread separation.

The pressure depends on the load and the speed of use. Adjust the pressure according to the conditions of use (refer to the label affixed to the driver side).

If tyre pressures cannot be checked when the tyres are **cold, the normal pressure values must be increased by 0.2 to 0.3 bar (or 3 PSI).**

**Never deflate a hot tyre.**

## Special note

Depending on the vehicle, there may be an adapter which needs to be positioned on the valve before air is added.

## Changing wheels around

## TYRES

This practice is not recommended.



Please be aware that a poorly tightened or missing valve cap can make the tyres less airtight and lead to pressure loss.

Always use valve caps identical to those fitted originally and tighten them fully.



### Vehicle fitted with a tyre pressure loss warning system

In the case of under-inflation

(punctures, etc.), the  warning light appears on the instrument panel. → 140

Reset the pressure reference value after each adjustment. → 140

### Fitting new tyres



For your safety reasons. Only tyres identical to those fitted originally or recommended by an approved dealer must be used.

Failure to follow these instructions could endanger your safety.

This could adversely affect stability, behaviour, braking or the clearance between the bodywork and the tyres.

**Some of these effects could lead to the loss of control of the vehicle under certain driving conditions.**



For your safety, please respect the speed limit. When they need to be replaced, only tyres of

the same make, size, type and profile should be used on a single axle.

**They must have a load capacity and speed rating at least equal to those of the original tyres and correspond to the tyres recommended by an approved Dealer.**

Failure to heed these instructions could endanger your safety and affect your vehicle's roadworthiness.

**Risk of loss of control of the vehicle.**

### Use in winter

#### Chains

**For safety reasons, fitting snow chains to the rear axle is strictly forbidden.**

**Chains cannot be fitted** to tyres which are larger than those originally fitted to the vehicle.

#### Snow or Winter tyres

## TYRES

In the interests of safety (vehicle traction quality), equip all four wheels of the vehicle.

**Warning :** These tyres sometimes have a specific direction of rotation and a maximum speed index which may be lower than the maximum speed of your vehicle.



Snow chains may only be fitted to tyres of the same size as those originally fitted to **your vehicle**.

### Studded tyres

This type of equipment may only be used for a limited period and as laid down by local legislation. It is necessary to observe the speed specified by current legislation.

These tyres must, at a minimum, be fitted to the two front wheels.



In all cases, we would recommend that you contact an authorised dealer who will be able to advise you on the choice of equipment which is most suitable for your vehicle.

### Tyre pressure

#### Label A



The tyre pressure is indicated on the label **A** affixed to the front driver. Tyre pressures should be checked when the tyres are cold.

If the tyre pressures cannot be checked when the tyres are **cold**, **increase the pressures from 0.2 to 0.3 bar (or 3 PSI)**. **Never deflate a hot tyre.**

70378

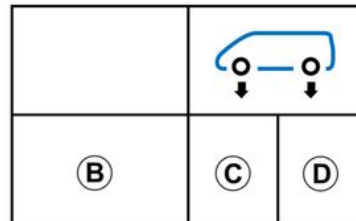
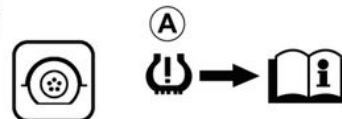

**B.** : dimension of the tyres fitted to the vehicle.

**C.** : tyre pressure for the front wheels.

**D.** : tyre pressure for the rear wheels.

## TYRES

**i** **Vehicle fitted with a tyre pressure loss warning system**

In the case of under-inflation

(punctures, etc.), the  warning light appears on the instrument panel → 140

**i** **Tyre safety and chain fitting:** for information on servicing conditions and, depending on the vehicle version, the use of chains → 220.



For your safety, please respect the speed limit. When they need to be replaced, only tyres of the same make, size, type and profile should be used on a single axle.

**They must : either have a load capacity and speed rating at least equal to those of the original tyres, or conform to those recommended by an authorised dealer.**

Failure to heed these instructions could endanger your safety and affect your vehicle's roadworthiness.

**Risk of loss of control of the vehicle.**

## Tools

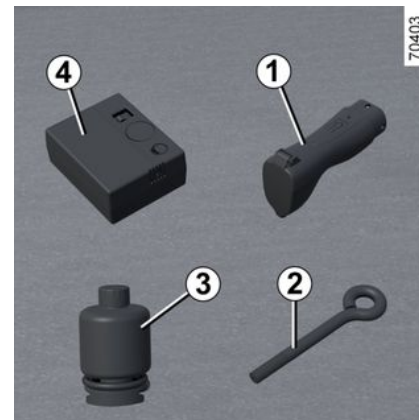

The presence of tools in the boot area depends on the vehicle.

Depending on the vehicle, the tool kit consists of:

- vehicle to load power gun **1**;
- towing ring **2**;
- container of anti-puncture product **3**;
- tyre inflation kit **4**.

## TYRES



Do not leave the tools unsecured inside the vehicle as they may be projected during braking.

After use, check that all the tools are correctly clipped into the tool kit, then position it correctly in its housing.

**Risk of injury.**

### Tool Locations

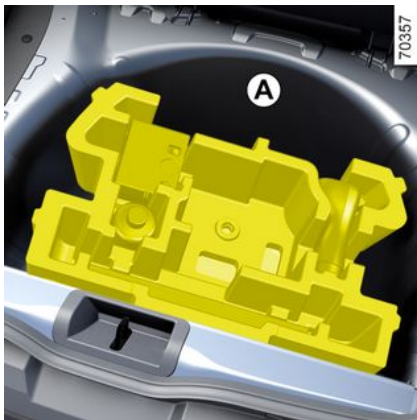

The tools included in the tool kit depend on the vehicle.

Tool Kit **A** located in the boot area.

### Tyre inflation kit



The kit repairs tyres when tread **A** has been damaged by objects smaller than 4 mm. It

cannot repair all types of puncture, such as cuts larger than 4 mm, or cuts in tyre sidewall **B**. Ensure also that the wheel rim is in good condition.

Do not pull out the foreign body causing the puncture if it is still in the tyre.



Do not attempt to use the inflation kit if the tyre has been damaged as a result of driving with a

puncture.

You should therefore carefully check the condition of the tyre sidewalls before any operation. Driving with underinflated, flat or punctured tyres can be dangerous and may make the tyre impossible to repair.

**This repair is temporary.**

A tyre which has been punctured should always be inspected (and repaired, where possible) as soon as possible by a specialist.

When taking a tyre which has been repaired using this kit to be replaced, you must inform the specialist.

When driving, vibration may be felt due to the presence of the repair product injected into the tyre.

## TYRES



The kit is only approved for inflating the tyres of the vehicle originally equipped with the kit.

It must never be used to inflate the tyres of another vehicle, or any other inflatable object (rubber ring, rubber boat, etc.).

Avoid spillage on skin when handling the repair product bottle. If droplets do leak out, rinse them off with plenty of water.

Keep the repair kit away from children.

Do not dispose of the empty bottle in the countryside. Return it to your approved dealer or to a recycling organisation.

The bottle has a limited service life which is indicated on its label. Check the expiry date.

Contact an approved dealer to replace the inflation tube and repair product bottle.

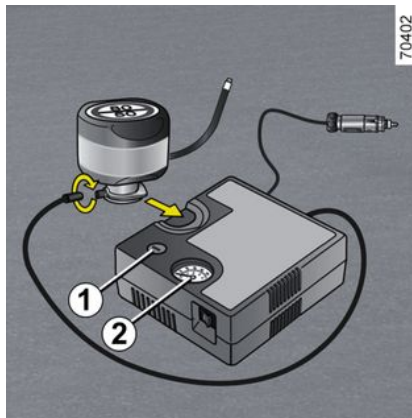

Depending on the vehicle, in the event of a puncture, use the kit located in the boot or underneath the boot carpet.



### Vehicle fitted with a tyre pressure loss warning system

In the event of under-inflation (puncture, low pressure, etc.), the



warning light lights up on the instrument panel → 140

**With the engine running and the parking brake applied,**

- Disconnect any accessories connected to the vehicle's accessories sockets;
- for vehicles fitted with a towing device, disconnect the towing plug if fitted;
- **Refer to the information on the inflation kit compressor** located in the boot of the vehicle and follow the instructions;
- Inflate the tyre to the recommended pressure → 222;
- After a maximum of **15** minutes, stop inflating and read the pressure (on pressure gauge 2);

**Note : while the bottle is emptying (approximately 30 seconds), the pressure gauge 2 will indicate briefly a pressure of 6 bar, then the pressure drops.**

- Adjust the pressure : to increase it, continue inflation with the kit ; to reduce it, press button 1.

**If a minimum pressure of 1.8 bar is not reached after 15 minutes, repair is not possible ; do not drive the vehicle but contact an approved dealer.**

## TYRES



Before using this kit, park the vehicle at a sufficient distance from traffic, switch on the hazard warning lights, apply the parking brake, ask all passengers to leave the vehicle and keep them away from traffic.



If the vehicle is parked on the hard shoulder, you must warn other road users of your vehicle's presence with a warning triangle or with other devices as per the legislation applying to the country you are in.

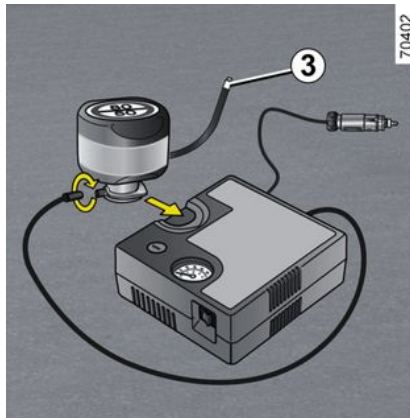

Once the tyre is correctly inflated, remove the kit : unscrew the inflation adapter slowly from the container **3** to prevent any product spatter and store the container in plastic packaging to prevent product leaks.

- Affix the driving recommendation label (located under the container) to the dashboard where the driver can see it.
- Put the kit away.
- At the end of this initial inflation operation, air will still escape from the tyre. You must drive a short distance in order to seal the hole.
- Start immediately and drive at a speed between 12 to 37 mph (20 to 60 km/h) in order to distribute the product evenly in the tyre ; after driving a

distance of 2 miles (3 km), stop and check the pressure.

- If the pressure is higher than 1.3 bar but lower than the recommended pressure (refer to the label affixed to the edge of the driver's door), adjust it. Otherwise, contact an approved dealer : the tyre cannot be repaired.

### Precautions when using the kit

The kit should not be operated for more than 15 consecutive minutes.

The container must be replaced after the first use even if liquid remains inside.



Nothing should be placed around the driver's feet as such objects may slide under the pedals during sudden braking manoeuvres and obstruct their use.

## TYRES



Please be aware that a poorly tightened or missing valve cap can make the tyres less airtight and may lead to pressure loss. Always use valve caps identical to those fitted originally and tighten them fully.



Following repair with the kit, do not travel further than 120 miles (200 km). In addition, reduce your speed and under no circumstances exceed 48 mph (80 km/h). The sticker, which you must affix in a prominent position on the dashboard, reminds you of this. Depending on the country or local legislation, a tyre repaired with the inflation kit may need to be replaced.

# BREAKDOWN RECOVERY

## Towing: breakdown

### Choice of breakdown service

#### In the event of an energy fault

In the event of a fully discharged traction battery, any type of towing is permitted : **towing on a flatbed truck or towing on the road** using the tow ring (please see following pages).

#### All other cases

**Only towing on a flatbed truck is permitted.**

#### Towing on a flatbed truck



Breakdown recovery **must** be performed on a flat surface under all circumstances except where the vehicle is immobilised following a full discharge of the traction battery. In the event of a total energy loss, please see the following pages.

Before any breakdown service, insert the key in the ignition to unlock the steering column. Turn it to position **M**.

The regulations in force for breakdown recovery must always be observed.

#### In the event of an energy fault : towing on the road



In the event of a fully discharged traction battery, it is possible to recover on a flatbed truck or tow the vehicle using the tow ring, following the instructions below.

Before towing, insert the key in the switch to unlock the steering column. Turn it to position **M**. Position the lever in neutral position **N**.

The column is unlocked, the accessory functions are supplied: the vehicle lights can be used (hazard warning lights, brake lights etc.). The towed vehicle's lights must be switched on at night.

The speed specified by current legislation for towing must always be observed.



When the engine is stopped, steering and braking assistance are not operational.



It is prohibited to hang the car to lower arm or Rear Axle. To hang car there is a specific place provided.

## BREAKDOWN RECOVERY

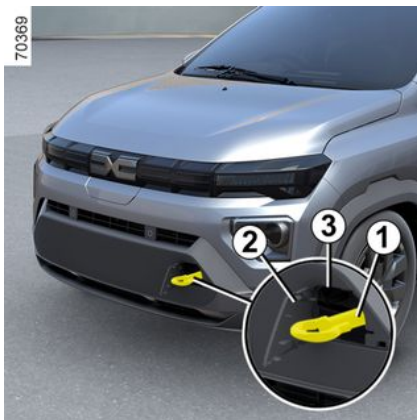
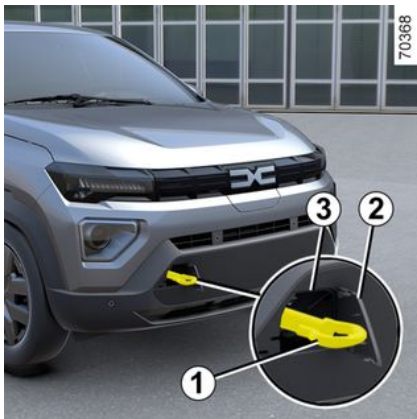

Front towing point 3.

This towing point must only be used for towing: never use it for lifting the vehicle directly or indirectly.



Ensure that the towing ring is bolted correctly.  
**Risk of losing the towed object.**

Unclip the cover **2** by inserting a flat-blade screwdriver or similar under the cover.

**Tighten the towing ring 1 fully** : first by hand until it stops.

Only use tow ring **1** located under the boot carpet in the tool kit → **223**.

**Note** : please do not use a damaged towing ring.



Do not remove the key from the ignition when the vehicle is being towed.



There is no rear towing point provided in the vehicle and is not suitable for towing any load



Do not leave the tools unsecured inside the vehicle as they may come loose under braking.

After use, check that all the tools are correctly clipped into the tool kit, then, depending on the vehicle, position it correctly in its housing.

**Risk of injury.**

### Battery: breakdown recovery

#### 12 V battery

The secondary battery is 12 V battery : this supplies energy to operate the vehicle equipment (lights, wind screen wipers, audio system etc..) and certain safety systems such as ABS.

## BREAKDOWN RECOVERY

 Do not use your electric vehicle to restart the 12 V battery in another vehicle. The 12 V electric power of an electric vehicle is not enough to perform such an operation.

**Risk of damage to vehicle**

 To avoid damaging your vehicle, do not recharge the secondary 12 V battery using:

- an external battery charger;
- a battery from another vehicle.

Please contact an authorised dealer.



When working in the engine compartment, certain parts may be hot. In addition, the engine cooling fan can come on at any moment.

**Risk of burns or serious injury.**



Do not throw away your used batteries ; give them to an organisation responsible for collecting and recycling batteries.

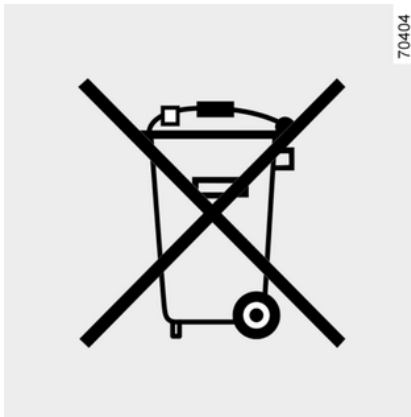

Some batteries may have specific conditions for recharging. Consult your approved dealer. Avoid the risk of sparks, as this could cause a sudden explosion, and always charge the battery in a well-ventilated area.

**Risk of serious injury.**



Handle the battery with care as it contains sulphuric acid, which must not come into contact with eyes or skin. If it does, wash the affected area with plenty of cold water and consult a doctor, if necessary. Ensure that naked flames, red hot objects and sparks do not come into contact with the battery as there is a risk of explosion. The engine may be hot when carrying out operations in close proximity. In addition, the engine cooling fan can come on at any moment.

**Risk of injury.**

# HEADLIGHTS, LIGHTS: REPLACING BULBS

## Exterior lighting: replacing bulbs

### Front lights

#### Changing bulbs

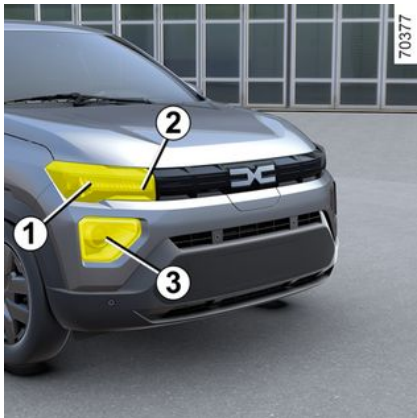

- LED Direction Indicator light **1**
- LED Daytime running/ Position light **2**
- High beam / low beam **3**

#### Main beam/ Dipped beam headlight

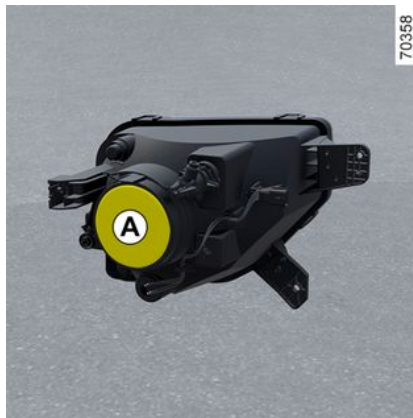

- Remove cover **A**.

**Bulb Type : HB3**



The engine may be hot during operations in close proximity. In addition, the engine cooling fan may come on at any moment.  
**Risk of injury.**

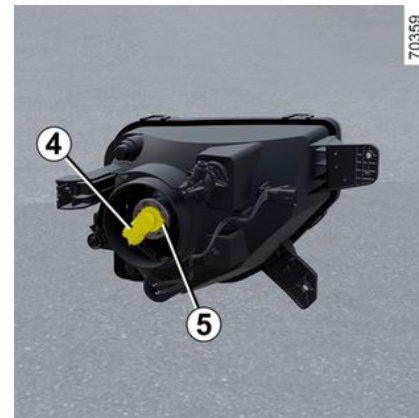

- Remove bulb connector **4**. Unclip spring **5** and take out the bulb.

**Do not touch the bulb glass, Hold it by the base.**

- It is essential to use anti U.V 55W bulbs, so as not to damage the plastic on the headlights. Mark the bulb's position before removal to ensure correct positioning when replacing. When the bulb has changed, make sure you refit the cover correctly.

#### **Direction Indicator light LED**

Please consult an authorised dealer.

## HEADLIGHTS, LIGHTS: REPLACING BULBS



The bulbs are under pressure and can break when replaced.

**Risk of injury.**



Any operation on (or modification to) the electrical system must be performed by an approved Dealer since an incorrect connection might damage the electrical equipment (harness, components and in particular the alternator). In addition, your dealer has all the parts required for fitting these units.



To comply with local legislation, or as a precaution, you can obtain an emergency kit containing a set of spare bulbs and fuses from an approved dealer.

### Rear lights

#### Changing bulbs

#### Position/ stop indicator lights LED 1



To disassemble the lamp 1, please consult an authorized dealer.

#### Rear side lights (Direction indicator lights 2/ Reversing lights 3)

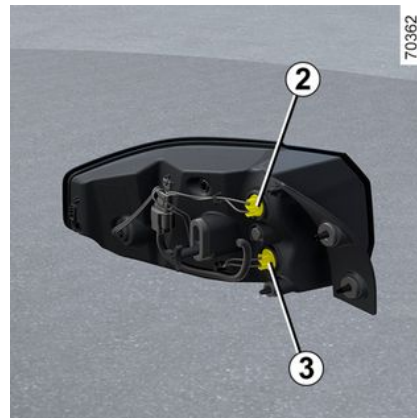

Turn bulb holder 2 or 3 and pull it out.  
Direction indicator light 2. **Bulb type : WY16W.**

Reversing light 3 **Bulb type : W16W.**



Take care when replacing bulbs. Changing their position may result in bulb operating faults.  
please consult an authorized dealer.

#### High level brake light 4

## HEADLIGHTS, LIGHTS: REPLACING BULBS



The bulb for high-level brake light **4** may be accessed through the boot. Slide the bulb cover downwards to release it.



Turn the bulb holder **5** a quarter of a turn, release it and remove the bulb.

**Bulb type : W16W.**

**New assembly**

To refit, proceed in the reverse order, taking care not to damage the wiring.

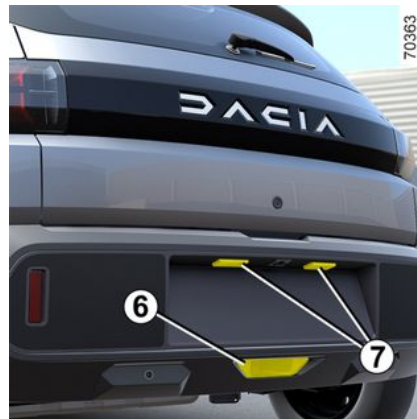

**Rear fog light 6**

Access the bulb holder located under the rear bumper, then unscrew it by turning towards the centre of the vehicle and remove the bulb.

**Bulb type: W16W.**

**Registration plate light LED 7**

Please consult an authorised dealer.

## HEADLIGHTS, LIGHTS: REPLACING BULBS

### Interior lighting: changing bulbs

#### Courtesy lights 1



Release the courtesy light **1** with a tool such as a flat-blade screwdriver.

Remove the bulb concerned.

**Bulb type : C5W.**



Take care when replacing bulbs. Changing their position may result in bulb operating faults.



The bulbs are under pressure and can break when replaced.

**Risk of injury.**

# WIPER BLADES: REPLACEMENT

## Replacing front windscreen wiper blades 1

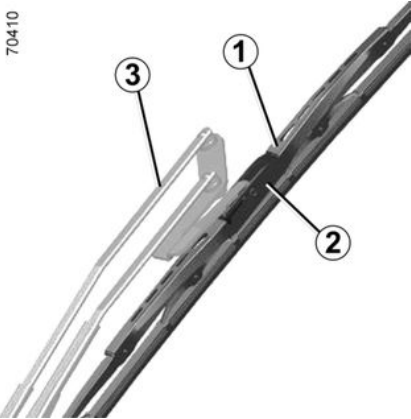

With the windscreen wipers in the off position and the ignition switched off, raise the windscreen wiper blade arm, **3**, press the tab **2** and push the blade downwards to release it from its housing.

### Refitting the front wiper blade

Slide the blade along the arm until it clips on. Make sure that the blade is correctly locked in position. Return the wiper to the park position.

When replacing the whole assembly, never press on the wiper blade rubber **1**.



– In frosty weather, make sure that the wiper blades are not stuck by ice (to avoid the risk of the motor overheating).

– Check the condition of the wiper blades. They should be replaced as soon as they become less efficient : approximately once a year.

When changing the blade, when it has been removed, do not let the wiper arm fall against the window : risk of breaking the window.

## Replacing rear windscreen wiper blades 4

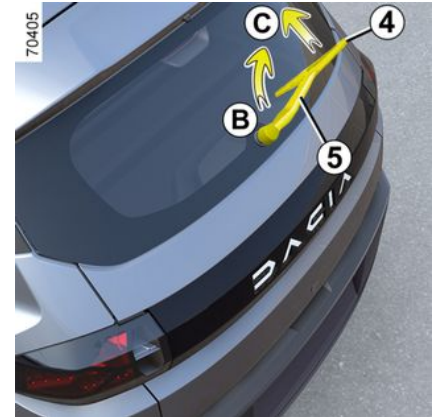

With the wiper in the park position and the ignition off, lift wiper arm **5**. Pivot wiper blade **4** until some resistance is met (**movement B**). **Pull the blade (movement CB)**. **Pull the blade (movement C)** to release it.

### Refitting the rear wiper blade

To refit the wiper blade, proceed in the reverse order to removal. Make sure that the blade is correctly locked in position.

## WIPER BLADES: REPLACEMENT



Check condition of the blades. You are responsible for their correct maintenance:

- clean the blades, windscreen and rear screen regularly with soapy water;
- do not use the wipers when the windscreen is dry;
- lift them off the windscreen when they have not been used for a long time.

# FUSES

## Fuse box



If any electrical component does not work, check the condition of the fuses.

Pull the flap **A** from the lower edge or, depending on the vehicle, pull the **B** flap to remove it to access the fuses.

### Clamp **C**

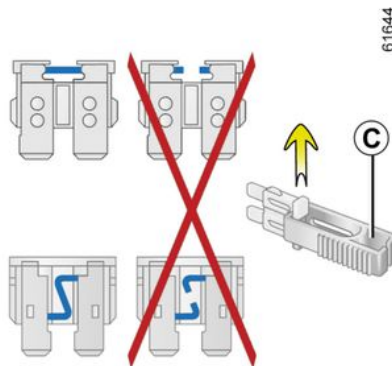

Remove the fuse using tweezers **C** located at the back of flap **A** or **B**.

To remove the fuse from the tweezers, slide the fuse to the side.

It is not advisable to use the free fuse locations.

 To comply with current legislation, or as a precaution, you can obtain an emergency kit from your approved dealer containing a set of spare bulbs and fuses.

 Check the fuse in question and **replace it, if necessary, by a fuse of the same rating.**











If a fuse is fitted with too high a rating, it may cause the electrical circuit to overheat (risk of fire) in the event of an item of equipment using an excessive amount of current.

## Allocation of fuses









(The presence and location of fuses depends on the vehicle equipment level)

Symbol	Allocation
	Parking Aid switch/Speed limiter



# FUSES

	Child safety relay/Auto-omatic light sensor
	EVC fuse
	Car sharing telematic box
	Front wiper
	Backup light relay (Rear lights/Ultra low cost navigation/BCM)
	Daylight running lamp/Right Tail Lamp, High Beam, Low Beam
	Radio/BCM/Energy management ECU
	Accessory socket
	Blower motor/AC control
	Front power window
<b>UCH</b>	BCM

Symbol	Allocation
	Roof lamp/Window lift control relay coil

	Cluster
<b>EMM</b>	Energy management ECU
	Horn
	Turn signal lights control
	Door locking
	Air conditioning compressor/Powertrain control relay coil
	Outside rear view mirror
<b>M</b>	BCM/Gear shift lever/Cluster/Energy management ECU
	Stoplight switch
	Rear wiper/washer/backup light relay
	Electronic power steering

Symbol	Allocation
	Airbag

	Defogger
<b>ESP</b>	Transponder/Electronic stability program/Stop lamp switch
	Rear power window
	Inverter

 Use the fuse allocation label in the storage compartment to identify the fuses. Certain fuses should only be replaced by a qualified professional. These fuses are not listed on the label. Only change the fuses represented on the labels.



### **Electrical and electronic accessories**

Before installing this type of accessory (particularly for transmitters/receivers: frequency bandwidth, power level, position of the aerial, etc.), make sure it is compatible with your vehicle. Contact an approved Dealer.

Before connecting an accessory to a socket, please ensure that it does not exceed the maximum power authorised for the socket → 202 → 197. **Fire hazard.**

Any work on the vehicle's electrical and/or electronic circuit must only be carried out by a qualified professional. Any incorrect connection and/or installation of electrical/electronic accessories not approved by the manufacturer may lead to:

- damage to the electrical and/or electronic equipment;
- damage to the components connected to it;
- the collection and use of vehicle data;
- an invasion of privacy (modification, deletion or unwarranted access to personal data).

### **Risk of serious accidents. Risk of invasion of privacy.**

If you have electrical equipment fitted in future, make sure that you are notified of the rating and position of the corresponding fuse.

### **Using the diagnostic socket**

The use of electronic accessories on the diagnostic socket may cause serious disturbance to the vehicle's electronic systems and/or cause invasion of privacy (modification, deletion or unwarranted access to personal data). For your safety we recommend that you use only electronic accessories approved by the manufacturer, consult an Approved Dealer. **Serious accident risk. Risk of invasion of privacy.**

### **Fitting aftermarket accessories**

If you wish to install accessories on the vehicle : please contact an authorised dealer. Also, to ensure the correct operation of your vehicle, and to avoid any risk to your safety, we recommend that you use only accessories specifically designed for your vehicle, which are the only accessories for which the manufacturer will provide a warranty.

If you are using an anti-theft device, only attach it to the brake pedal.

### **Obstructions to the driver**

On the driver's side, only use mats suitable for the vehicle, attached with the pre-fitted components, and check the fitting regularly. Do not lay one mat on top of another. **There is a risk of wedging the pedals**

## OPERATING FAULTS

The following advice will enable you to carry out quick, temporary repairs. For safety reasons you should always contact an approved dealer as soon as possible.

Faults	POSSIBLE CAUSES	WHAT TO DO
Impossible to charge the traction battery.	No electrical current in domestic sockets or poor connection of cable to domestic socket.	Check your installation (circuit breaker, programmer, etc.). Check the connections (charging socket etc) → 26.
	The exterior temperature is lower than -26 °C.	Recharge your vehicle in a more suitable environment → 228.
	The cord is defective.	Please see an authorised dealer to replace it.
	The charging cord is not correctly locked to the vehicle	Plug the charging cable correctly into the vehicle → 26.
The steering column remains locked.	Steering wheel locked.	To unlock, turn the key and the steering wheel → 127.
	Desynchronisation of remote control	Unlock the driver's door using the key in the door lock, then start the engine to synchronise the remote control

On the road	POSSIBLE CAUSES	WHAT TO DO
Steering becomes heavy.	Tyres not inflated to the correct pressure, incorrectly balanced or damaged.	Check the tyre pressures : if this is not the problem, have them checked by an approved Dealer.
Vibrations.	Tyres not inflated to correct pressures, incorrectly balanced or damaged.	Check the tyre pressures ; if this is not the cause, have their condition checked by an approved dealer.
	Coolant leaks.	Check the coolant reservoir : it should contain fluid. If there is no coolant, consult an

## OPERATING FAULTS

On the road	POSSIBLE CAUSES	WHAT TO DO
		authorised dealer as soon as possible.
Electrical equipment	POSSIBLE CAUSES	WHAT TO DO
The wiper does not work.	Wiper blade stuck.	Free the blades before using the wipers.
	Faulty electrical circuit.	Consult an approved dealer.
	Fuse damaged.	Replace the fuse → 237.
The wiper does not stop.	Faulty electrical controls.	Consult an approved dealer.
Direction indicators flashing more quickly.	Bulb blown.	Replace the bulb → 237.
The direction indicators do not work.	Faulty electrical circuit.	Consult an approved dealer.
	Fuse damaged.	Replace the fuse → 237.
The headlights do not switch on or off.	Faulty electrical circuit or control.	Consult an approved dealer.
	Fuse damaged.	Replace the fuse
Traces of condensation in the headlights or rear lights.	<p>This is not a fault. Traces of condensation may be a natural phenomenon caused by variations in temperature and humidity</p> <p>In this case, the traces will disappear slowly once the lights are switched on.</p>	

# INFORMATION ABOUT THE VEHICLE

## Vehicle identification plates

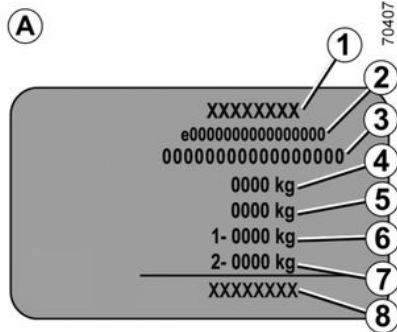
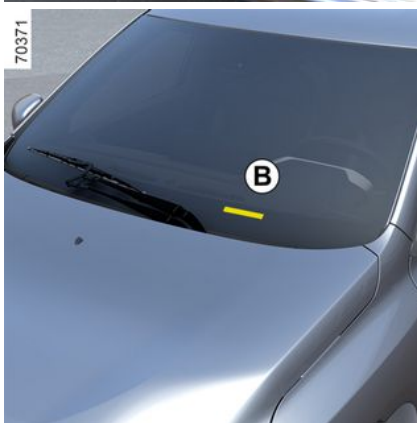

The information shown on the vehicle identification plate should be quoted on all correspondence or orders.

### Vehicle identification plate A

1. Manufacturer name.
2. EC design number or approval number.
3. Identification number.

**B.** Depending on the vehicle, this information is also given on marking .

4. MMAC (Maximum Authorised mass).
5. MTR (Gross Train Weight : vehicle fully loaded with trailer)

6. MMTA (Maximum Permissible Weight) front axle.

7. MMTA rear axle.

8. Manufacturer address.

## Engine identification, engine specifications

### Engine identification plates



### Engine specification

Engine type : 4DB

## INFORMATION ABOUT THE VEHICLE

70408

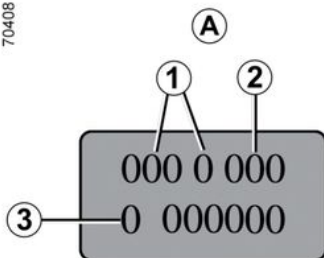

**Please quote the information on the engine plate or label A in all correspondence or orders.**

(Location varies depending on engine)

1. Engine type.
2. Engine suffix.
3. Engine number.

### Technical information for the emergency services



The QR Code on the label **A** allows emergency workers using a tablet or smartphone to immediately access the technical information useful for working on the vehicle in the event of an accident

Ensure that the label **A** is always visible and present on the windscreen as well as the rear screen

**Any modification or damage would prevent access to the information**



# INFORMATION ABOUT THE VEHICLE

## Dimensions (in metres)

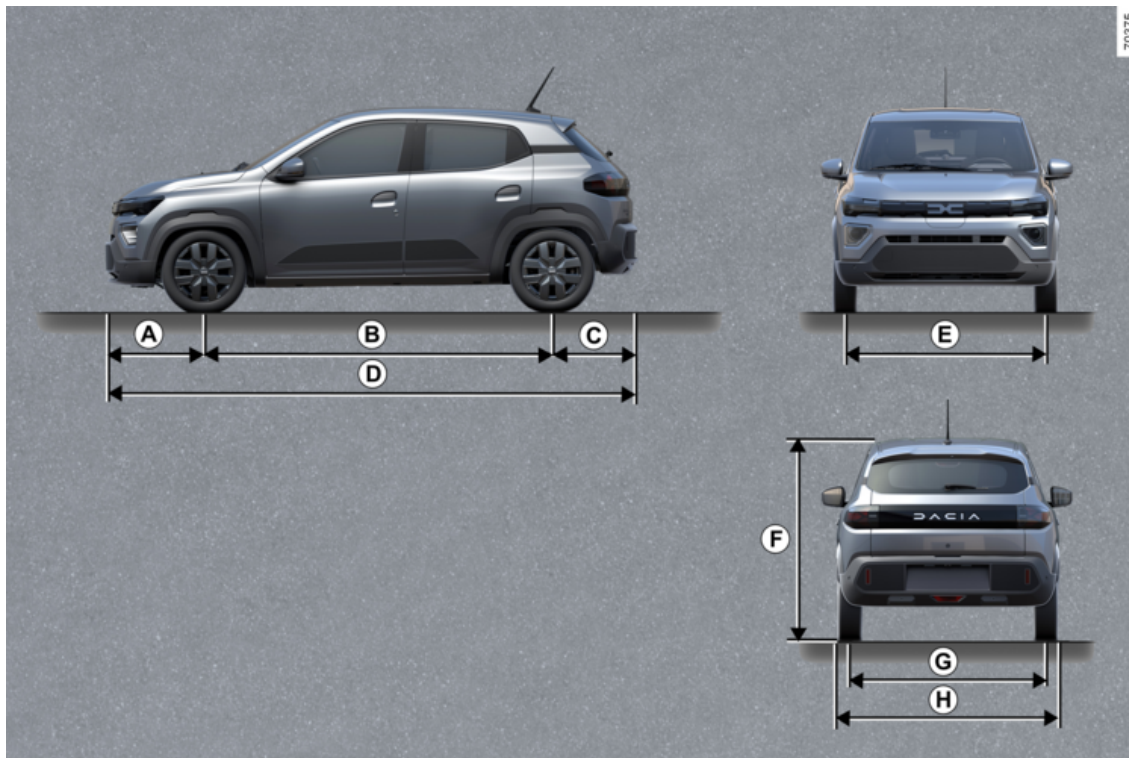

## INFORMATION ABOUT THE VEHICLE

	Dimensions
<b>A</b>	0.683
<b>B</b>	2.423
<b>C</b>	0.595
<b>D</b>	3.701
<b>E</b>	1,390
<b>F</b>	1,485
<b>G</b>	1,375
<b>H</b>	1622 to 1767 – 1767 with rear view mirrors open – 1622 with rear view mirrors folded away

## INFORMATION ABOUT THE VEHICLE

### Weights (in kg)

The weights indicated for a basic vehicle without options : they vary depending on the vehicle's equipment. Consult your approved Dealer.

<b>Maximum authorised mass(MMAC) Maximum permissible weight (MMTA) Gross train weight (MTR)</b>	<b>Weights indicated on the vehicle identification plate → 242</b>
<b>Braked Trailer Weight</b>	<b>prohibited</b>
<b>Unbraked Trailer Weight</b>	<b>prohibited</b>
<b>Permissible nose weight</b>	<b>prohibited</b>
<b>Maximum permissible load on the roof with the carrying device</b>	<b>prohibited</b>

7

## REPLACEMENT PARTS AND REPAIRS

Original parts are based on very stringent specifications and are subjected to specific tests. Therefore, they are of at least the same level of quality as the parts fitted originally.

If you always fit genuine replacement parts to your vehicle, you will ensure that it performs well. Furthermore, repairs carried out in the approved dealer network with original parts are guaranteed according to the conditions stated on the back of the repair order.

# SERVICE SHEETS

VIN: .....

Date:	Miles (km):	Invoice number:	Comments/miscellaneous
<b>Type of operation:</b>		<b>Stamp</b>	
Service <input type="checkbox"/>			
..... <input type="checkbox"/>			
<b>Anticorrosion check:</b>			
OK <input type="checkbox"/> Not OK* <input type="checkbox"/>			
Date:	Miles (km):	Invoice number:	Comments/miscellaneous
<b>Type of operation:</b>		<b>Stamp</b>	
Service <input type="checkbox"/>			
..... <input type="checkbox"/>			
<b>Anticorrosion check:</b>			
OK <input type="checkbox"/> Not OK* <input type="checkbox"/>			
Date:	Miles (km):	Invoice number:	Comments/miscellaneous
<b>Type of operation:</b>		<b>Stamp</b>	
Service <input type="checkbox"/>			
..... <input type="checkbox"/>			
<b>Anticorrosion check:</b>			
OK <input type="checkbox"/> Not OK* <input type="checkbox"/>			

\* See specific page

7

# SERVICE SHEETS

VIN: .....

Date:	Miles (km):	Invoice number:	Comments/miscellaneous
<b>Type of operation:</b> Service <input type="checkbox"/> ..... <input type="checkbox"/>		<b>Stamp</b>	
<b>Anticorrosion check:</b> OK <input type="checkbox"/> Not OK* <input type="checkbox"/>			
Date:	Miles (km):	Invoice number:	Comments/miscellaneous
<b>Type of operation:</b> Service <input type="checkbox"/> ..... <input type="checkbox"/>		<b>Stamp</b>	
<b>Anticorrosion check:</b> OK <input type="checkbox"/> Not OK* <input type="checkbox"/>			
Date:	Miles (km):	Invoice number:	Comments/miscellaneous
<b>Type of operation:</b> Service <input type="checkbox"/> ..... <input type="checkbox"/>		<b>Stamp</b>	
<b>Anticorrosion check:</b> OK <input type="checkbox"/> Not OK* <input type="checkbox"/>			

\* See specific page

# SERVICE SHEETS

VIN: .....

Date:	Miles (km):	Invoice number:	Comments/miscellaneous
<b>Type of operation:</b>		<b>Stamp</b>	
Service <input type="checkbox"/>			
..... <input type="checkbox"/>			
<b>Anticorrosion check:</b>			
OK <input type="checkbox"/> Not OK* <input type="checkbox"/>			
Date:	Miles (km):	Invoice number:	Comments/miscellaneous
<b>Type of operation:</b>		<b>Stamp</b>	
Service <input type="checkbox"/>			
..... <input type="checkbox"/>			
<b>Anticorrosion check:</b>			
OK <input type="checkbox"/> Not OK* <input type="checkbox"/>			
Date:	Miles (km):	Invoice number:	Comments/miscellaneous
<b>Type of operation:</b>		<b>Stamp</b>	
Service <input type="checkbox"/>			
..... <input type="checkbox"/>			
<b>Anticorrosion check:</b>			
OK <input type="checkbox"/> Not OK* <input type="checkbox"/>			

\* See specific page

7

# SERVICE SHEETS

VIN: .....

Date:	Miles (km):	Invoice number:	Comments/miscellaneous
<b>Type of operation:</b> Service <input type="checkbox"/> ..... <input type="checkbox"/>		<b>Stamp</b>	
<b>Anticorrosion check:</b> OK <input type="checkbox"/> Not OK* <input type="checkbox"/>			
Date:	Miles (km):	Invoice number:	Comments/miscellaneous
<b>Type of operation:</b> Service <input type="checkbox"/> ..... <input type="checkbox"/>		<b>Stamp</b>	
<b>Anticorrosion check:</b> OK <input type="checkbox"/> Not OK* <input type="checkbox"/>			
Date:	Miles (km):	Invoice number:	Comments/miscellaneous
<b>Type of operation:</b> Service <input type="checkbox"/> ..... <input type="checkbox"/>		<b>Stamp</b>	
<b>Anticorrosion check:</b> OK <input type="checkbox"/> Not OK* <input type="checkbox"/>			

\* See specific page

# SERVICE SHEETS

VIN: .....

Date:	Miles (km):	Invoice number:	Comments/miscellaneous
<b>Type of operation:</b>		<b>Stamp</b>	
Service <input type="checkbox"/>			
..... <input type="checkbox"/>			
<b>Anticorrosion check:</b>			
OK <input type="checkbox"/> Not OK* <input type="checkbox"/>			
Date:	Miles (km):	Invoice number:	Comments/miscellaneous
<b>Type of operation:</b>		<b>Stamp</b>	
Service <input type="checkbox"/>			
..... <input type="checkbox"/>			
<b>Anticorrosion check:</b>			
OK <input type="checkbox"/> Not OK* <input type="checkbox"/>			
Date:	Miles (km):	Invoice number:	Comments/miscellaneous
<b>Type of operation:</b>		<b>Stamp</b>	
Service <input type="checkbox"/>			
..... <input type="checkbox"/>			
<b>Anticorrosion check:</b>			
OK <input type="checkbox"/> Not OK* <input type="checkbox"/>			

\* See specific page

# SERVICE SHEETS

**VIN:** .....

Date:	Miles (km):	Invoice number:	Comments/miscellaneous
<b>Type of operation:</b> Service <input type="checkbox"/> ..... <input type="checkbox"/>		<b>Stamp</b>	
<b>Anticorrosion check:</b> OK <input type="checkbox"/> Not OK* <input type="checkbox"/>			
Date:	Miles (km):	Invoice number:	Comments/miscellaneous
<b>Type of operation:</b> Service <input type="checkbox"/> ..... <input type="checkbox"/>		<b>Stamp</b>	
<b>Anticorrosion check:</b> OK <input type="checkbox"/> Not OK* <input type="checkbox"/>			
Date:	Miles (km):	Invoice number:	Comments/miscellaneous
<b>Type of operation:</b> Service <input type="checkbox"/> ..... <input type="checkbox"/>		<b>Stamp</b>	
<b>Anticorrosion check:</b> OK <input type="checkbox"/> Not OK* <input type="checkbox"/>			

\* See specific page

# ANTICORROSION CHECK

If the continuation of the warranty is subject to repair, it is indicated below.

**VIN:** .....

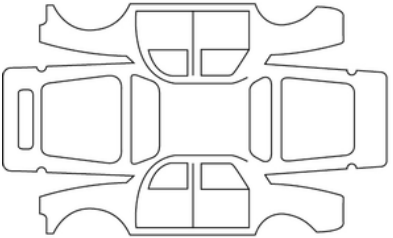
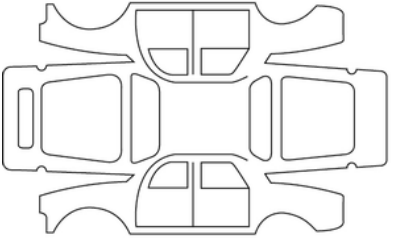
Date of repair:		<b>Stamp</b>
Corrosion repair operation to be carried out:		
Date of repair:		<b>Stamp</b>
Repair to be carried out:		

7

# ANTICORROSION CHECK

If the continuation of the warranty is subject to repair, it is indicated below.

**VIN:** .....

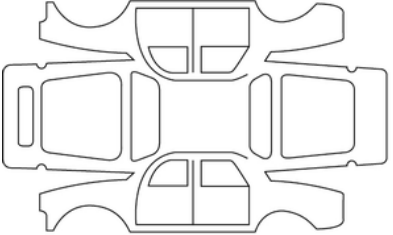
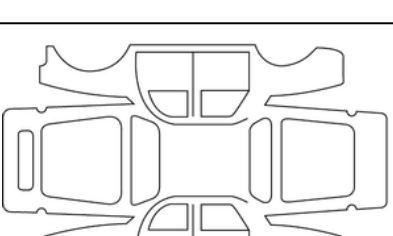
Date of repair:		<b>Stamp</b>
Corrosion repair operation to be carried out:		
Date of repair:		<b>Stamp</b>
Repair to be carried out:		

# ANTICORROSION CHECK

If the continuation of the warranty is subject to repair, it is indicated below.

**VIN:** .....

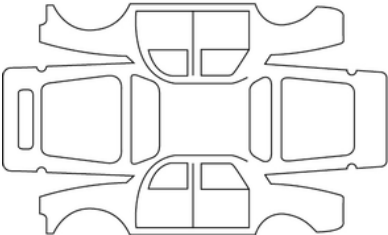
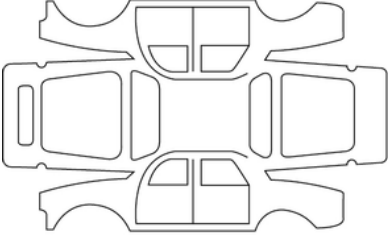
Date of repair:		<b>Stamp</b>
Corrosion repair operation to be carried out:		
Date of repair:		<b>Stamp</b>
Repair to be carried out:		

7

# ANTICORROSION CHECK

If the continuation of the warranty is subject to repair, it is indicated below.

**VIN:** .....

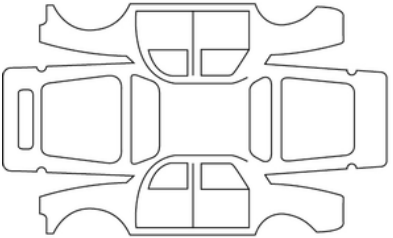
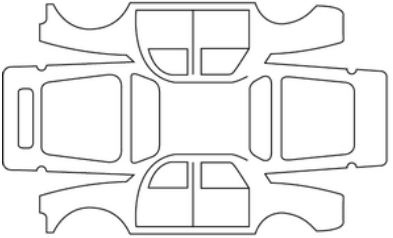
Date of repair:		<b>Stamp</b>
Corrosion repair operation to be carried out:		
Date of repair:		<b>Stamp</b>
Repair to be carried out:		

# ANTICORROSION CHECK

If the continuation of the warranty is subject to repair, it is indicated below.

**VIN:** .....

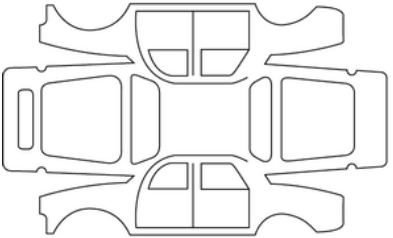
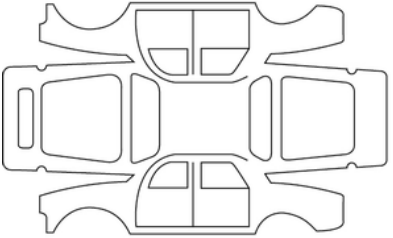
Date of repair:		<b>Stamp</b>
Corrosion repair operation to be carried out:		
Date of repair:		<b>Stamp</b>
Repair to be carried out:		

7

# ANTICORROSION CHECK

If the continuation of the warranty is subject to repair, it is indicated below.

**VIN:** .....

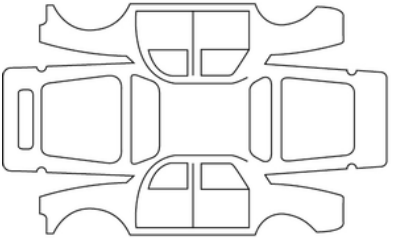
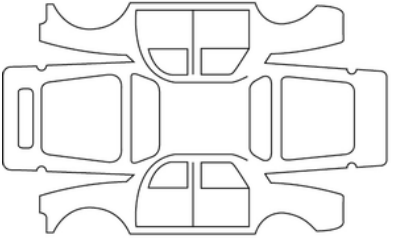
Date of repair:		<b>Stamp</b>
Corrosion repair operation to be carried out:		
Date of repair:		<b>Stamp</b>
Repair to be carried out:		

# ANTICORROSION CHECK

If the continuation of the warranty is subject to repair, it is indicated below.

**VIN:** .....

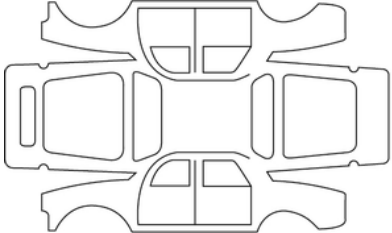
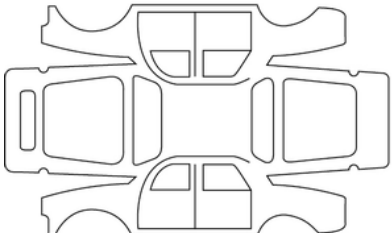
Date of repair:		<b>Stamp</b>
Corrosion repair operation to be carried out:		
Date of repair:		<b>Stamp</b>
Repair to be carried out:		

7

# ALPHABETICAL INDEX

## A

Accessories socket, [202](#), [202](#), [204](#)  
Access to the engine compartment, [209](#)  
Adjusting your driving position, [61](#)  
Airbag, [92](#)  
Airbag : activating the front passenger airbag, [92](#)  
Airbag : activating the front passenger airbags, [92](#)  
Airbag : deactivating the front passenger airbag, [92](#), [92](#)  
Airbags : child safety, [92](#)  
Air conditioning, [192](#), [195](#)  
Air conditioning: information and advice for use, [195](#)  
Air vents, [192](#)  
Air Vents, [191](#)  
Ashtray, [202](#)  
Ashtrays, [202](#)  
Audible and visual signals, [124](#)

## B

Battery, [214](#), [214](#)  
Battery: troubleshooting, [229](#)  
Battery (remote control), [49](#)  
Battery troubleshooting, [229](#)  
Bonnet, [209](#)  
Bulbs changing, [231](#)

## C

Central door locking, [51](#), [52](#)  
Changing a bulb, [231](#)

Changing gear, [129](#)  
Charging cable, [41](#)  
Charging cord, [28](#)  
Charging flap, [28](#)  
Charging programming, [41](#)  
Charging socket, [28](#)  
Child booster seat, [75](#)  
Children, [92](#)  
Child restraint/seat, [75](#)  
Child safety, [47](#), [75](#), [75](#), [92](#)  
Child seats, [75](#), [80](#)  
Cigarette lighter, [202](#)  
Cigar lighter, [202](#)  
Cleaning : inside the vehicle, [218](#)  
Closing the doors, [51](#), [51](#)  
Control instruments, [113](#)  
Cruise control, [173](#)  
Cruise control - Speed limiter, [173](#)

## D

Detection of road signs, [168](#)  
Display, [106](#)  
Doors, [51](#), [51](#), [52](#)  
Driver assistance, [168](#)  
Driver vigilance warning, [166](#)  
Driving, [173](#)  
Driving aids, [168](#)  
Driving position, [94](#)

# ALPHABETICAL INDEX

## E

Electrical installation, [28](#)  
Electric door locking, [52](#)  
Electric vehicle, [20](#)  
Electric vehicle charge, [28](#)  
Electric vehicle important recommendations, [28](#)  
Electric windows, [200](#)  
Emergency spare wheel, [220](#)  
Energy charge, [28](#)  
Engine coolant, [211](#)  
Engine identification, [242](#)  
Engine specifications, [242](#)  
Excessive speed warning, [168](#)  
Exterior lighting and signals, [120](#)  
Exterior lights, [231](#)

## F

Fitting a child seat, [80](#)  
Fittings, [204](#)  
Front seat adjustment, [58](#)  
Front seats, [58](#), [58](#)  
Front seats adjustment, [58](#)

## G

Gear control, [129](#)  
Gear lever, [129](#)  
Glove box, [204](#)

## H

Handbrake, [129](#)  
Hazard warning lights signal, [124](#)  
Heating and air conditioning system, [191](#), [192](#), [192](#), [195](#)  
Heating system, [191](#), [192](#), [192](#), [195](#)  
Horn, [124](#)

## I

Indicators, [231](#)  
Indicators : direction indicators, [124](#)  
Instrument panel, [113](#)  
Interior lighting, [201](#)  
Interior lighting: changing bulbs, [234](#)  
Interior lighting : changing bulbs, [234](#)  
Interior trim maintenance, [218](#)

## K

Key/Remote control, [47](#)  
Keys, [47](#)

## L

Levels, [209](#), [212](#)  
Lighting : exterior, [231](#)  
Lights : dipped beam headlights, [231](#)  
Lights : direction indicators, [231](#)  
Lights : main beam headlights, [231](#)  
Lights: replacing bulbs, [231](#)

# ALPHABETICAL INDEX

Lights : side lights, [231](#)  
Locking/unlocking the doors, [52](#)  
Locking the doors, [51](#)

## M

Maintenance: filters, [212](#)  
Maintenance : interior trim, [218](#)

## O

Opening elements, [51](#)  
Opening the doors, [51](#), [51](#)  
Operating faults, [92](#)

## P

Parking distance control, [180](#)  
Passenger safety: front passenger airbag, [92](#)  
Power consumption, [106](#)  
Practical advice, [231](#)

## R

Radio frequency remote control/key use, [47](#)  
Rear headrests, [59](#)  
Rear seat, [59](#)  
Rear seats, [59](#)  
Rear view mirrors, [119](#)  
Remote control/key: batteries, [49](#)  
Remote control door locking batteries, [49](#)  
Remote control door locking unit, [47](#)

Replacement and repair parts, [247](#)  
Replacing windscreen wiper blades, [235](#)  
Reverse gear selecting, [129](#)  
Reversing camera, [185](#)

## S

Seat belts, [61](#), [61](#)  
Speed limiter, [173](#)  
Starting the engine, [127](#)  
Stopping the engine, [127](#)  
Storage compartment, [204](#)  
Storage compartment/ fittings: passenger compartment, [204](#)  
Storage compartments, [204](#)

## T

Tailgate, [55](#)  
Tanks and reservoirs : windscreen washer, [211](#)  
Tanks and reservoirs coolant, [211](#)  
Towing: breakdown, [228](#)  
Towing breakdown, [228](#)  
Towing hitch, [228](#)  
Traction battery charge, [28](#)  
Transporting children, [75](#)  
Trip computer, [100](#)  
Troubleshooting: battery, [229](#)  
Troubleshooting: towing the vehicle, [228](#)  
Tyre pressure, [220](#), [222](#)  
Tyres, [220](#), [220](#)

# ALPHABETICAL INDEX

## V

Ventilation heating and air conditioning system, [192](#), [195](#)

## W

Warning buzzer, [51](#)

Warning lights, [113](#)

Windows, [200](#)

Windscreen washer, [211](#)

Wiper blades: replacement, [235](#)





7711417635

Réf 7711417635 / Edition anglaise  
NU 1489-2 – 10/2024

