

DACIA



**VEHICLE
USER
MANUAL**

JOGGER

Welcome aboard your vehicle

This user manual contains the information required:

- **to better understand your vehicle** in order to take full advantage of its features and advanced technologies and to use them in the best possible conditions.
- **to ensure that it works correctly** by carefully following maintenance advice.
- **to carry out operations efficiently**, without wasting time, **only** when the operation does not need to be performed by a specialist.

Read this manual to discover useful information, features and technical updates that will enrich your driving experience. If certain points are still unclear, our Network technicians will be only too pleased to provide you with any additional information.

For guidance, please see the following symbols:



visible in the vehicle, indicate that you should consult the manual for detailed information and/or limits on operations with respect to your vehicle's equipment.

→ , present throughout the manual, provides a link to another section in the document.



anywhere in the manual indicates a hazard, danger or a safety recommendation.

The description of the models given in this manual is based on the technical specifications valid at the time of writing. This document does not include any corrections or supplements to the digital version, which should remain the reference manual. It is therefore recommended to consult the digital version regularly in order to access the most up-to-date information.

The manual covers all of the equipment (standard or optional) available for these models. Whether the equipment is fitted to the vehicle depends on the version, the options selected and the country where the vehicle is sold.

This document may also contain information about items of equipment to be introduced later in the model year.

Furthermore, the functions described in this manual are also subject to future modification due to updates, regulations or technical constraints.

The diagrams in the user manuals are provided as examples.

Enjoy driving your new vehicle.

Copying or translation, in part or in full, is forbidden unless prior written permission has been obtained from the vehicle manufacturer.

Translated from French.

CONTENTS

Welcome aboard your vehicle	4	Audible and visual signals	147
Exterior	4	Wiper	148
Passenger compartment	6	Fuel tank	154
Driver's position	8	Reagent tank	157
Driving aids	10	Driving	161
Safety on board	12	Running in.....	161
Identifying a vehicle - Labels	14	Starting, stopping the engine	162
The engine compartment (routine maintenance).....	16	Gear control	172
Breakdown recovery.....	18	Parking brake.....	180
The Hybrid vehicle	20	Special features of Diesel versions	185
The LPG vehicle	22	Special features of petrol versions	187
Getting to know your vehicle	24	Environment.....	189
Vehicle HYBRID.....	24	Maintenance and antipollution advice	191
LPG vehicle	31	Driving advice, eco-driving	192
Card	37	Tyre Pressure Monitoring System	197
Key, remote control.....	45	Tyre Pressure Loss Warning	202
Doors and opening elements.....	50	Driver correction devices and aids	208
Front seats.....	57	Additional driving aid functions	213
Rear seats	59	Speed limiter.....	251
Seat belts.....	66	Cruise control.....	254
Additional safety devices	72	Parking aids	259
Child safety	82	Emergency call	274
Child seats.....	88	Your comfort	278
Child safety: deactivating, activating the front passenger airbag.....	105	Air vents, heating and air conditioning.....	278
Driving position	108	Multimedia equipment	291
Trip computer.....	112	Passenger compartment equipment.....	296
Warning lights	132	Passenger compartment storage, fittings	303
Steering	138	Transporting objects	309
Rear view.....	140	Maintenance	319
Lighting and signals	142	Accessing the engine, levels	319

CONTENTS

Battery	327
Cleaning.....	331
Practical advice.....	335
Tyres	335
Breakdown recovery.....	348
Headlights, lights: replacing bulbs	355
Wiper blades: replacement.....	366
Fuses	368
Fitting a radio.....	370
Installation and use of accessories.....	371
Operating faults	373
Technical specifications	378
Information about the vehicle	378
Replacement parts and repairs	386
Service sheets	387
Anticorrosion check	393

EXTERIOR

1

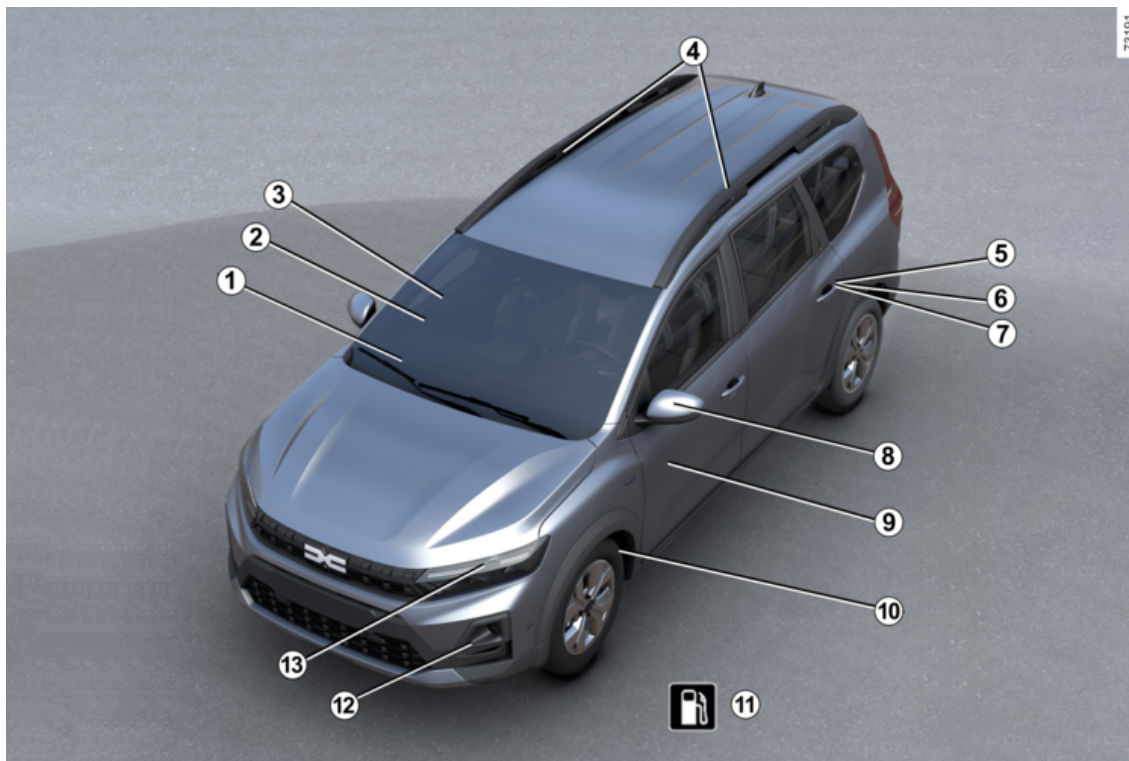

EXTERIOR

- 1** Demisting → 281 and → 285
- 2** Windscreen wiper(s) → 148
- 3** Electric windows → 296
- 4** Carrying equipment → 313
- 5** Key/remote control → 45
- 6** → 37 card
- 7** Locking/unlocking the doors → 51
- 8** Rear view mirrors → 140
- 9** Bodywork maintenance → 331
- 10** Tyres → 335
- 11** Filling up with fuel/LPG → 154
- 12** Lights: replacement → 355
- 13** Lights: operation → 142

PASSENGER COMPARTMENT

1

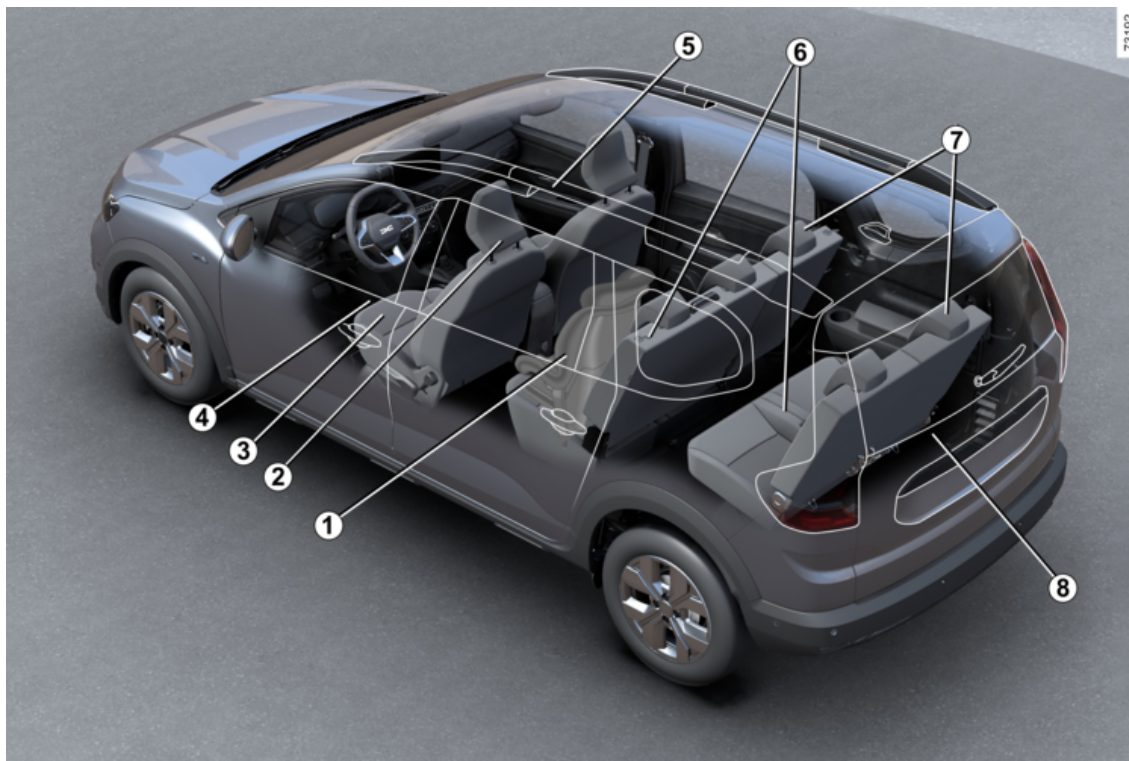

6 - Welcome aboard your vehicle

PASSENGER COMPARTMENT

- 1** Child safety → **82**
- 2** Front headrests → **57**
- 3** Front seats → **57**
- 4** Adjusting your driving position → **66**
- 5** Passenger compartment storage/features → **303**
- 6** 2nd row rear seats → **60**
- 3rd row rear seats → **61**
- 7** Rear headrests → **59**
- 8** Luggage compartment storage/fitings → **310**

DRIVER'S POSITION

1

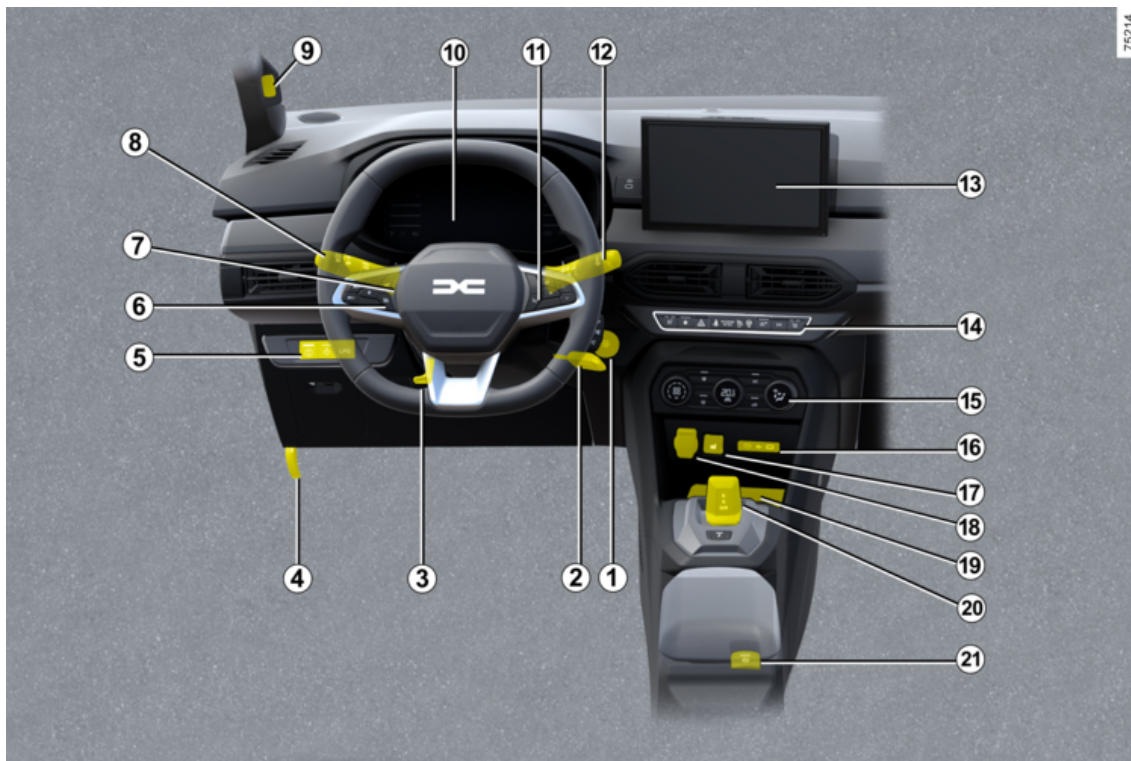

8 - Welcome aboard your vehicle

DRIVER'S POSITION

- 1** Engine start/stop button → 162
- 2** Key ignition switch → 162
- 3** Steering wheel adjustment → 138
- 4** Bonnet release → 319
- 5** Controls for:
 - My Safety → 213 ;
 - Heated steering wheel or, depending on the vehicle, switch for general activation/deactivation of Park Assist;
 - LPG Command → 31
- 6** Speed limiter → 251
- 7** Cruise control → 254
- 8** Exterior lighting → 142
- 9** Interior camera → 240
- 10** Instrument panel → 132
- 11** On-board computer controls → 112
- 12** Screen wash/wipe stalk → 148
- 13** Multimedia screen → 291
- 14** Heated seat(s) controls → 57
- 15** Heating system/air conditioning → 281
- 16** USB-C → 291 sockets
- 17** Depending on the vehicle, the traction control activation/deactivation control - Extended grip → 208
- 18** Accessories socket → 291
- 19** Telephone charging/storage area → 291
- 20** Gear lever → 172
- 21** Electronic parking brake activation/deactivation control → 180

DRIVING AIDS

1



79120

DRIVING AIDS

- ABS (anti-lock braking system) → 208
- ESC (electronic stability control) → 208
- Braking assistance → 208
- Hill Start Assist → 208
- Traction control -Extended grip → 208
- Stop and Start → 168
- Tyre pressure monitoring system → 197
- Tyre pressure loss warning → 202
- My Safety → 213
- Lane departure prevention → 214
- Blind spot warning → 222
- Safe distance warning → 227
- Driver vigilance warning → 238
- Driver fatigue warning → 243
- Driver attention warning → 240
- Road sign detection → 246
- Speed limiter → 251
- Cruise control → 254
- Reversing camera → 259
- Multi-view camera → 262
- Park Assist → 268

SAFETY ON BOARD

1

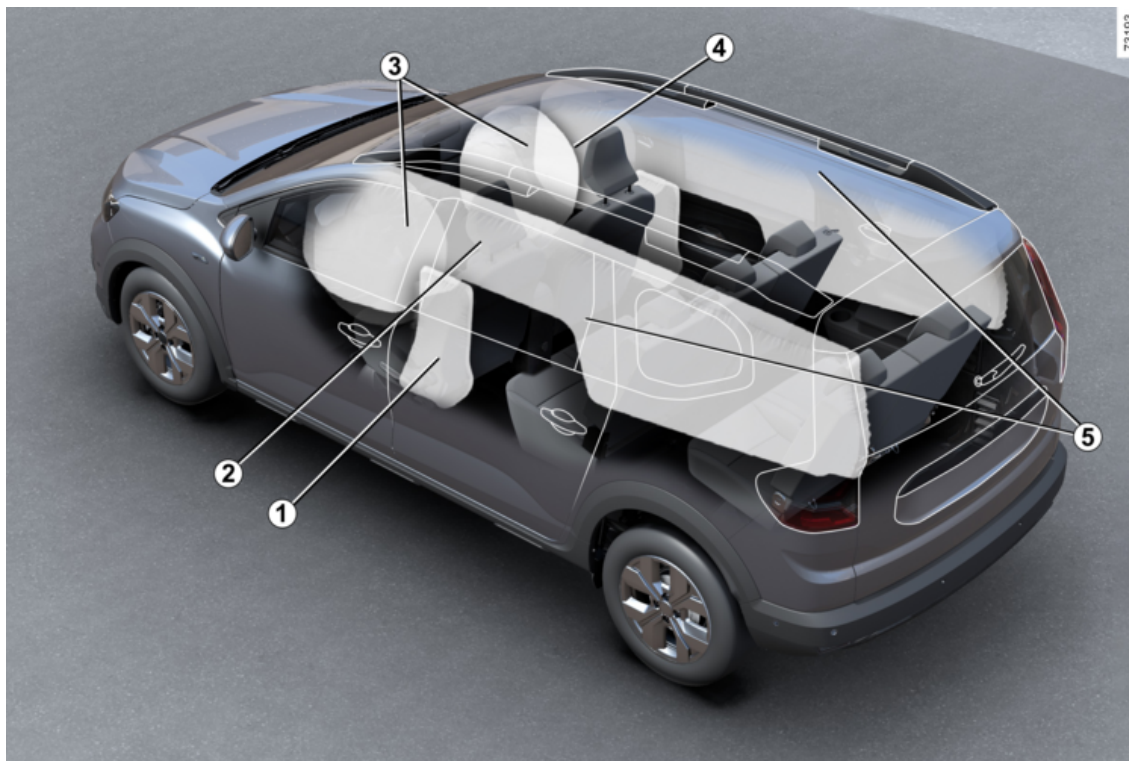

SAFETY ON BOARD

- 1** Airbags side → **77**
- 2** Seat belts → **66**
- 3** Airbags Front → **72**
- 4** Frontal passenger airbag inhibition → **72**
- 5** Airbags Curtain → **78**

IDENTIFYING A VEHICLE - LABELS

1

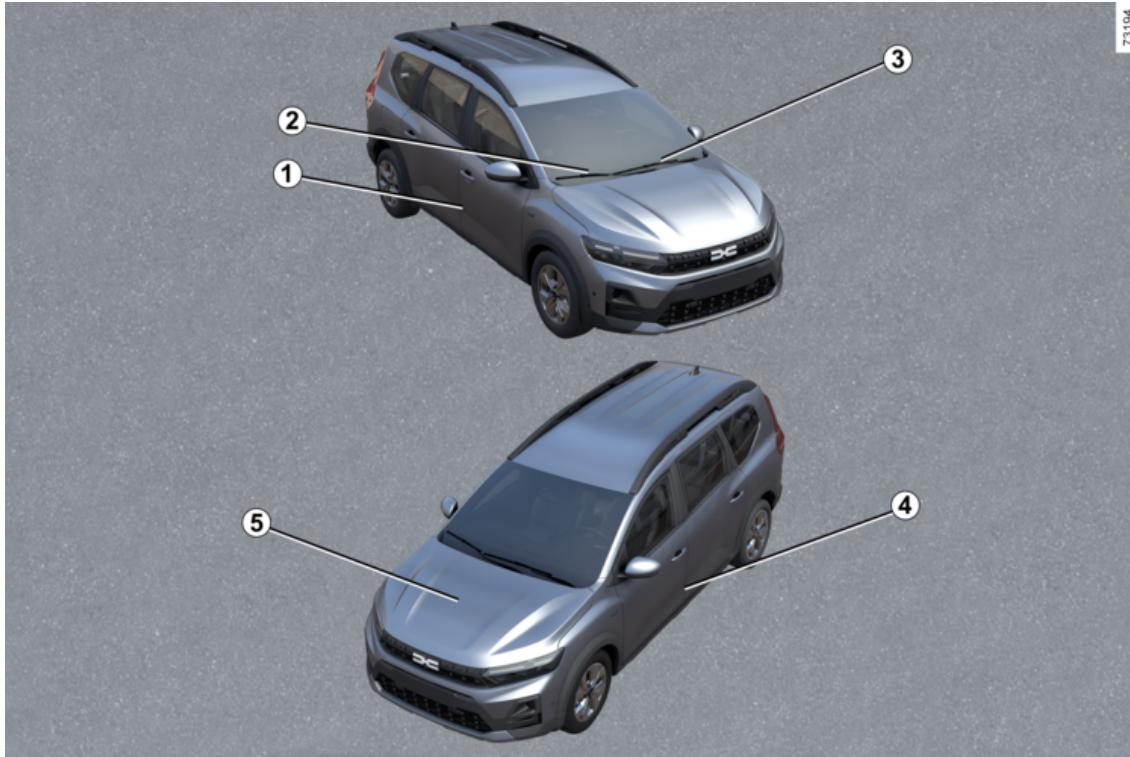

IDENTIFYING A VEHICLE - LABELS

- 1** Vehicle identification plate → **378**
- 2** Technical information for the emergency services → **378**
- 3** Vehicle identification number reminder → **378**
- 4** Tyre pressure labels → **202** → **337**
- 5** Engine identification → **379**

THE ENGINE COMPARTMENT (ROUTINE MAINTENANCE)

1

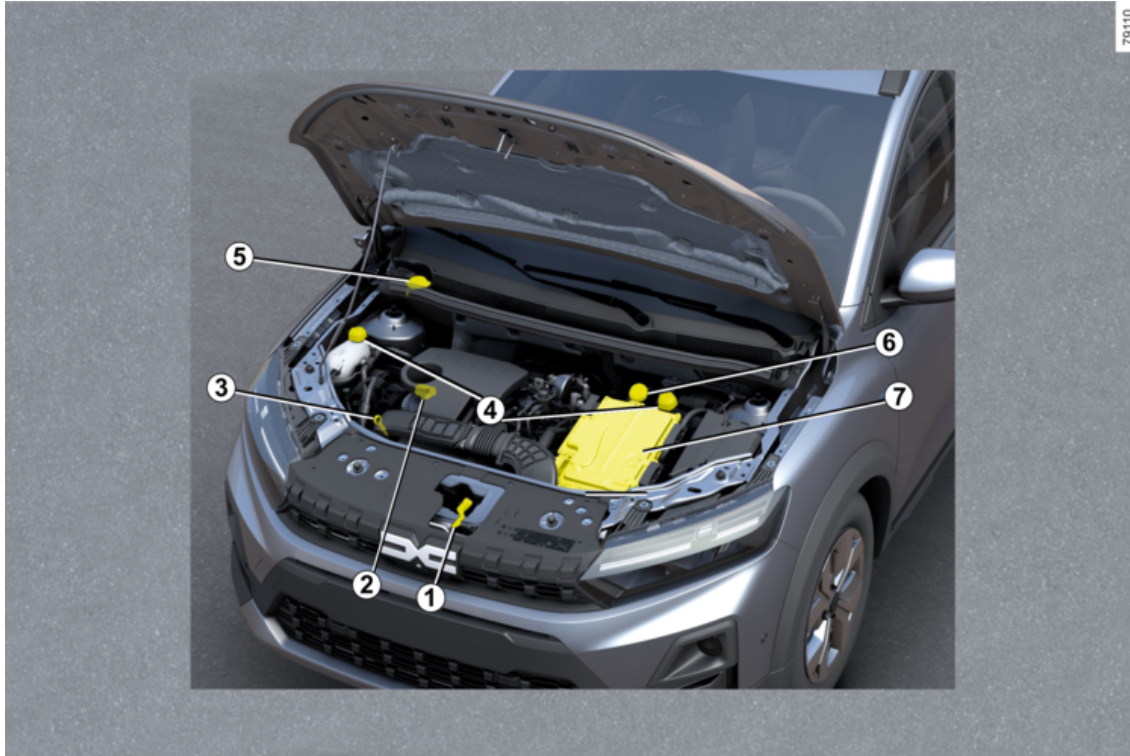

THE ENGINE COMPARTMENT (ROUTINE MAINTENANCE)

- 1** Opening the bonnet → **319**
- 2** Engine oil filler cap → **320**
- 3** Engine oil dipstick → **320**
- 4** Coolant → **324**
- 5** Screen washer fluid → **325**
- 6** Brake fluid → **319**
- 7** Battery → **327**

BREAKDOWN RECOVERY

1

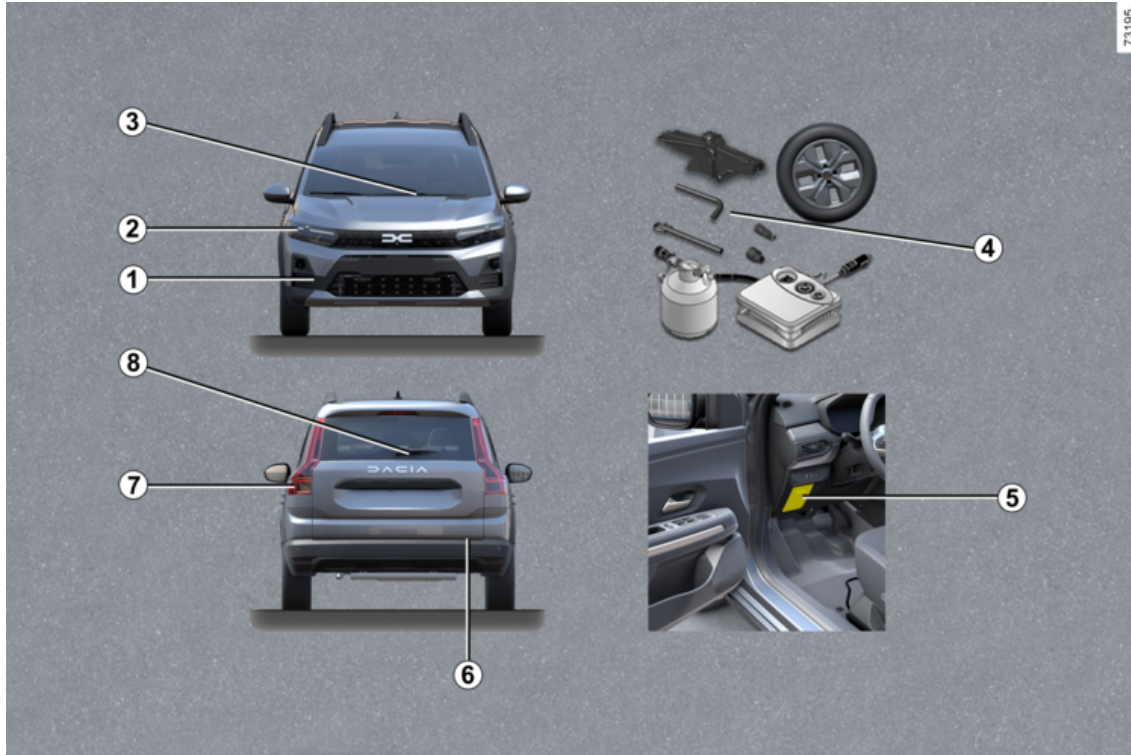

BREAKDOWN RECOVERY

- 1** Front towing point → **348**
- 2** Replacing headlight bulbs → **355**
- 3** Replacing windscreen wiper blade(s) → **366**
- 4** Puncture: tools → **341**
- Emergency spare wheel → **343**
- Changing a wheel → **197**
- 5** Fuses → **368**
- 6** Rear towing point → **348**
- 7** Replacing the rear light bulbs → **360**
- 8** Replacing the rear screen wiper blade → **366**

THE HYBRID VEHICLE

1

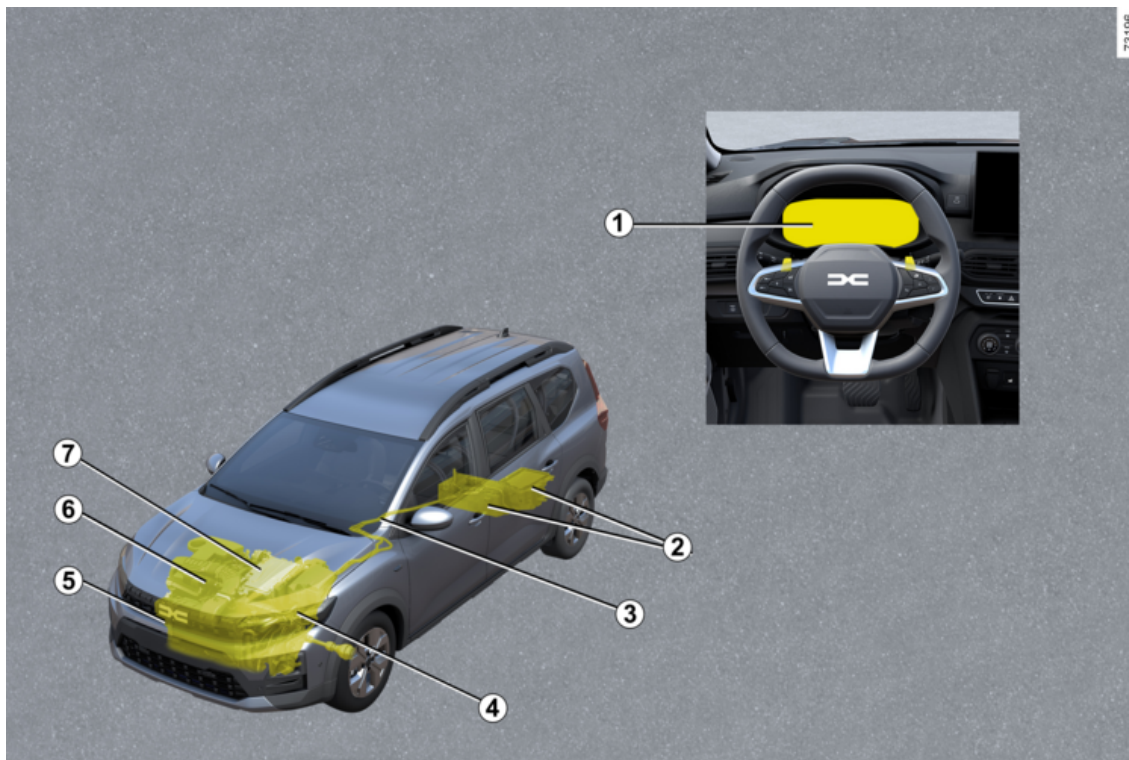

THE HYBRID VEHICLE

Hybrid vehicle system: introduction → 24

Hybrid vehicle system: important recommendations → 30

1 Warning lights → 132

Displays and indicators → 124

Charge meter → 192

2 → 24 → 327 → 353 batteries

3 Orange electrical power cables → 24

4 Electric motor → 24

5 Towing, breakdown recovery → 348

6 Combustion engine → 24

7 Coolant → 324

THE LPG VEHICLE

1

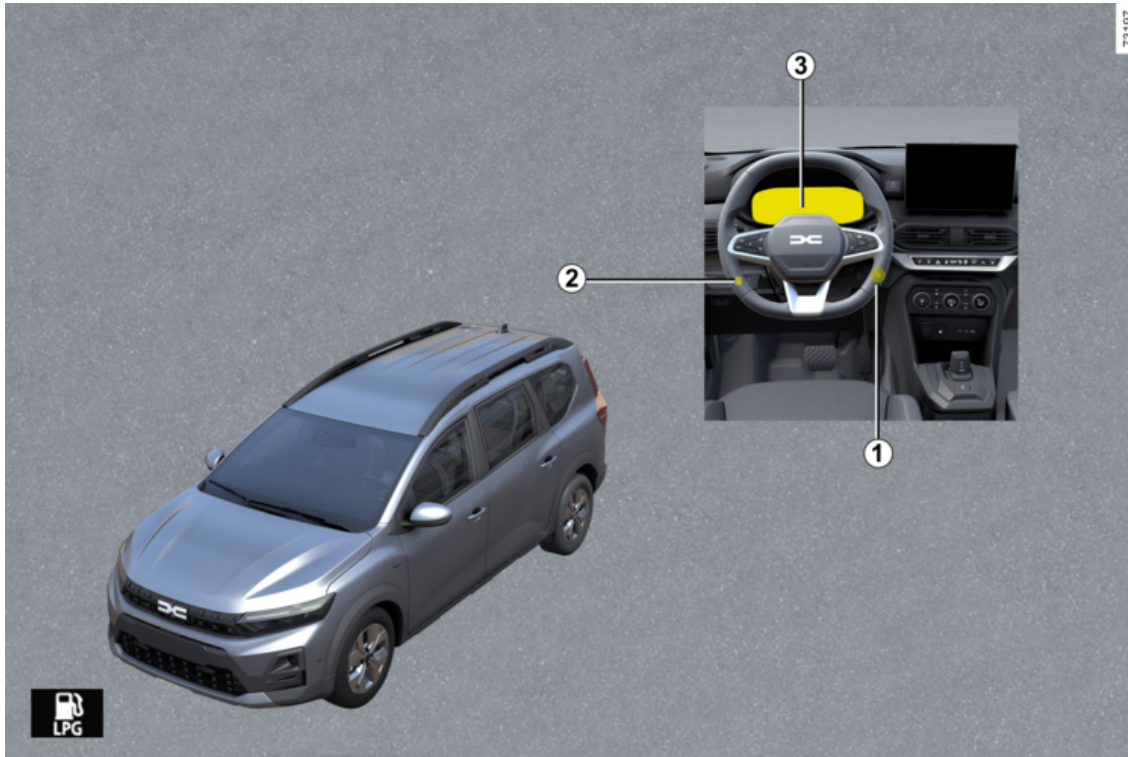

THE LPG VEHICLE

1 Starting, stopping the engine: vehicle with key → **162**

Starting, stopping the engine: vehicle with → **164** card

2 LPG control → **31**

3 Trip computer → **112**



LPG filling → **154**

VEHICLE HYBRID

Introduction

2

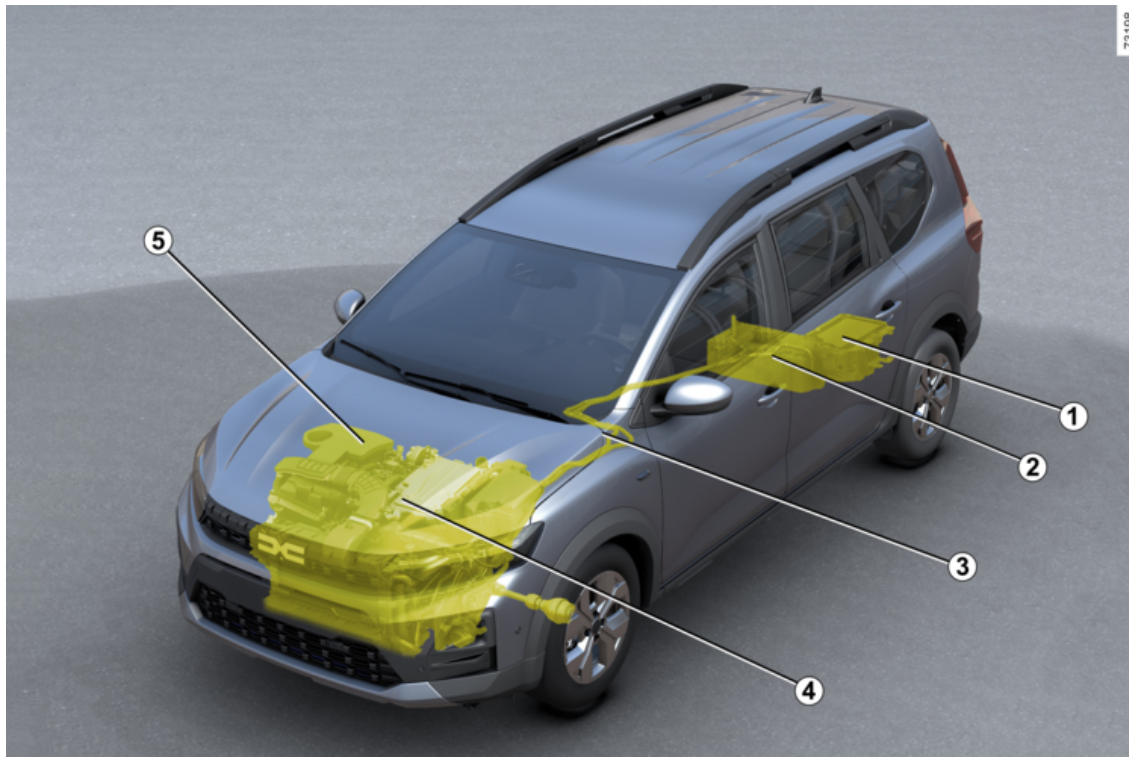

VEHICLE HYBRID

- 1 "12 Volt" battery
- 2 "High-voltage" traction battery
- 3 Orange electrical power cables
- 4 Electric motor
- 5 Combustion engine

The Hybrid vehicle system uses an electric motor to improve the performance of the combustion engine (acceleration, starting, etc.).

The vehicle has more acceleration torque available while consuming less fuel.

The vehicle may also move in all-electric operating mode without any assistance from the combustion engine. The vehicle uses the energy stored in the "High voltage" traction battery.

Batteries

The Hybrid vehicle is equipped with two types of battery:

- a "high voltage" traction battery;
- a "12 V" battery.

"High voltage" traction battery

This battery, located underneath the rear floor, stores the energy required for the electric motor to operate correctly.

As with any battery, it discharges when it is used. The traction battery is charged:

- during the vehicle deceleration phases;
- when the combustion engine starts automatically in order to act as a generator.

Your vehicle range in electric operating mode depends on the charge level of the traction battery, and also on your driving style and the components consuming energy (air conditioning, heating system etc.).

In the event of traction battery discharge, the combustion engine alone moves the vehicle until the traction battery is sufficiently recharged.

If your vehicle is parked for a long time, start the engine at regular intervals (about once a month) and check

that the  warning light is displayed in blue on the instrument panel. If this happens, the battery needs to be recharged: leave the engine on until the warning light is displayed in blue → 124.

Failure to do so may result in damage to the traction battery and make it impossible to start the vehicle.

"12 V" battery

The "12 V" battery, located in the luggage compartment, supplies the energy required to open/close the vehicle and to operate the equipment.

Note: the "12 V" battery does not help to start the combustion engine. This is provided by the Hybrid system.



The Hybrid vehicle uses a "high voltage" electrical system.

This system can get hot during and after switching off the ignition. Respect warning messages given on the labels in the vehicle.

All operations or modifications on the vehicle's "high voltage" electrical system (components, cables, connectors, traction battery) are strictly prohibited due to the risks they present to your safety. Call an approved Dealer.

The risk of serious burns or electric shocks can lead to death.

VEHICLE HYBRID

A

2



The **A** symbol identifies the electrical elements in your vehicle which may present safety risks.

79119

"High voltage" electrical circuit

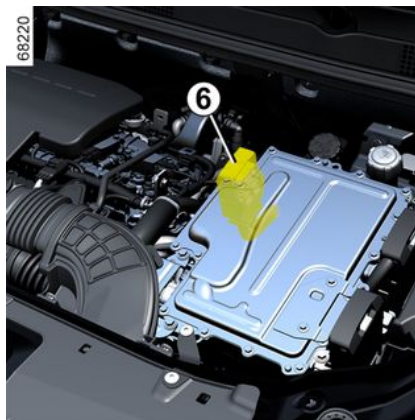

The "high voltage" electrical circuit can be recognised by the orange cables **6**

and parts bearing the  symbol.

The Hybrid system selects the combustion engine and/or the electric engine according to the driving style (smooth or sporty driving, etc.) and traffic conditions.

Bad weather, flooded roads:





Do not drive through floods if the depth of water is above the lower edge of the wheel rims.

Energy flow indicator 7

62292



Depending on the driving mode selected, the warning light **7** represents the energy flows between:

-  the electrical assembly (traction battery and electric motor);
-  the combustion engine;
-  the wheels.

VEHICLE HYBRID

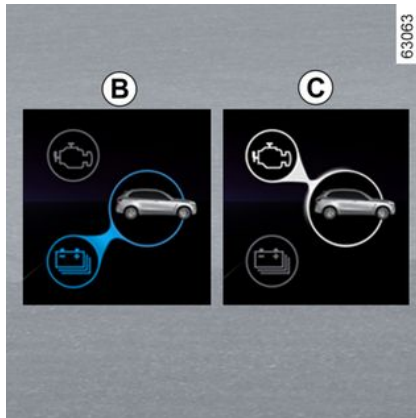
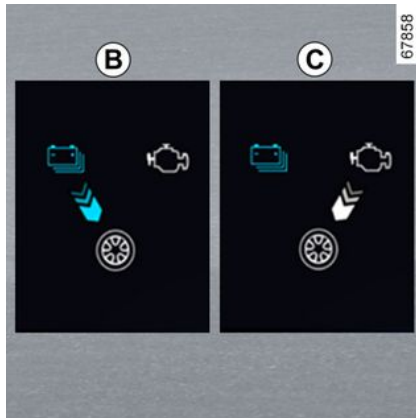

The colour of flows varies:

– blue: electrical energy;

– white: energy produced by the combustion engine.

"Electric traction" *B* flow

The electrical assembly is used to move the vehicle.

"Combustion engine traction" *C* flow

The combustion engine is used to move the vehicle.

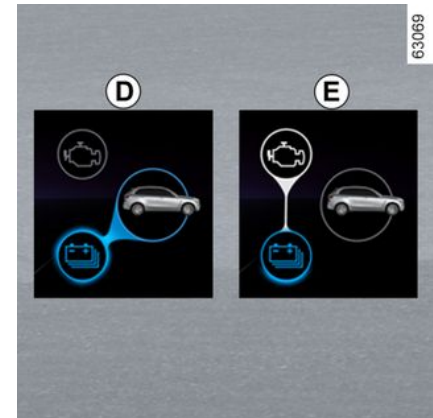
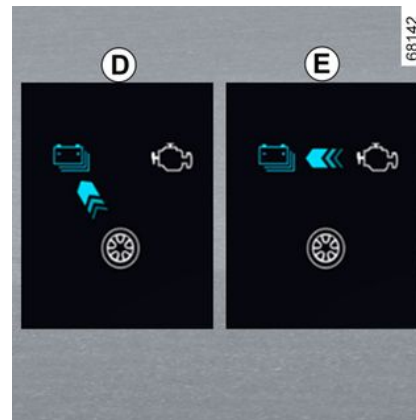

"Energy recovery" *D* flow

When you lift your foot off the accelerator pedal or when you press on the brake pedal, the electric motor and/or the regenerative braking system convert the energy produced by the vehicle deceleration into electric energy.

This is used to brake the vehicle and recharge the traction battery.

"Energy production" *E* flow

The combustion engine recharges the traction battery.

Note: a combination of different flows is possible (e.g. combining flow *B* and flow *C* means that the combustion engine and the electric motor are being used to move the vehicle).

VEHICLE HYBRID

2



Special case

When the traction battery reaches a maximum charge level, the engine brake is temporarily reduced. Please adapt your driving style appropriately.



The engine brake should under no circumstances be used as a substitute for the brake pedal.

All-electric driving mode

62294

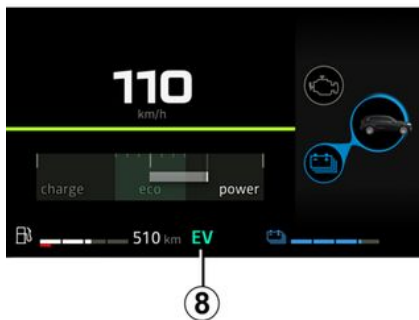

The warning light **8 EV** is displayed on the instrument panel to inform you that the Hybrid system is using only the electrical assembly to power the vehicle movement.



It is recommended that you do not drive in all-electric mode with the fuel tank empty.

If the orange  warning light appears on the instrument panel and a beep sounds, fill the tank with fuel as soon as possible.

Risk of immobilisation

If there is no fuel in the tank, the vehicle automatically switches to all-electric mode.

If you drive until the traction battery is depleted, it will be impossible to restart the vehicle (even after refuelling). Call an approved Dealer.

Noise

The Hybrid vehicles are particularly quiet in electric operating mode. You will not yet necessarily be used to it, and neither will other road users. It is

difficult for them to hear your vehicle when it is moving.

To warn people of your vehicle presence, your vehicle is fitted with a pedestrian horn. In electric operating mode, the system is activated automatically. The sound is emitted when the vehicle speed is between approximately 1 and 19 mph (1 and 30 km/h). As the electric motor is silent, you will hear noises that may seem unusual (aerodynamic noises, tyres, etc.) as well as noises due to the operation of the Hybrid system (e.g. cooling of the traction battery).

Pedestrian horn

The pedestrian horn enables you to warn others of your presence – especially pedestrians and cyclists.

When the engine is started, the pedestrian horn is activated automatically. The sound is emitted when the vehicle speed is between approximately 1 and 19 mph (1 and 30 km/h).

In the event of a fault with the pedestrian horn, the "Failure Outside sound" message is displayed on the instrument panel. Consult an approved Dealer.

VEHICLE HYBRID



Your vehicle Hybrid is very quiet. When getting out of the vehicle, always check that the gear selector is in **P** position, apply the parking brake and switch off the ignition.

RISK OF SERIOUS INJURY.

VEHICLE HYBRID

Important recommendations

2



Please read these instructions carefully. Failure to follow these instructions may lead to **a risk of fire, serious injury or electric shocks which could result in death.**

In the event of an accident or impact

In the event of an accident or an impact to the underside of the vehicle (e.g. striking a post, raised kerb or other street furniture) the electric circuit or the traction battery may be damaged.

Have the vehicle checked by an authorised Dealer.

Never touch "high voltage" components or orange cables which are exposed and visible inside or outside the vehicle.

In the event of serious damage to the traction battery, leaks may occur:

- never touch liquids (fluids, etc.), coming from the traction battery;
- in the event of contact with the body, wash the affected area with plenty of water and consult a doctor as soon as possible.

In the event of fire

In the event of a fire, exit and evacuate the vehicle, contact the emergency services and inform them that the vehicle is a Hybrid.

Only use extinguishing agents ABC or BC that are permitted for use with electrical fires. Do not use water or other extinguishing agents.

In the event of damage to the electrical circuit, please contact an authorised Dealer.

All towing operations

Refer to the paragraph entitled "Towing, breakdown recovery" → 348.

Washing the vehicle

Never wash the engine compartment or the "high voltage" traction battery with a high-pressure jet.

This risks damaging the electric circuit.

Risk of electric shock and a risk to life.

LPG VEHICLE

Introduction

These vehicles operate by bi-fuelling using two types of fuel: LPG and petrol. They have two separate tanks → 154.

What is LPG?



Liquefied petroleum gas that complies with the EN 589 standard or the equivalent national legislation.

It can be readily identified by its characteristic smell.



LPG/petrol fuel mode selection control 1

This enables the driver to manually switch from one fuel mode to another.

The **LPG** warning light appears in grey on the instrument panel to indicate that the system is waiting for the required conditions to met before switching to LPG mode.

The **LPG** warning light appears in white or, depending on the vehicle, in green to indicate that LPG mode is activated.



LPG fuel gauge and warning light

The **LPG** warning light is displayed on the instrument panel 2 along with the associated LPG fuel gauge.

The amount of LPG indicated is an indicative value.

Operation

Starting the engine



The engine is always started using petrol.

- For vehicles with a key → 162.
- For vehicles with a card → 164.

Note: if LPG mode is active when the engine is started, the system will temporarily switch to "petrol" mode:

- the **LPG** warning light appears in grey on the instrument panel 2 without a beep but accompanied by the dis-

LPG VEHICLE

play of the  warning light and the associated "petrol" fuel level. This indicates that petrol mode is active.

As soon as the required conditions are met (engine temperature level, etc.), the system automatically switches to

LPG mode: the  warning light appears or, depending on the vehicle, in green when LPG mode is activated.

Switching fuel while driving

To switch from petrol mode to LPG mode manually

Press control **1**.

The switch to LPG mode is performed automatically when the system is ready:

– the  warning light and the associated LPG fuel level are displayed on the instrument panel **2**;

– the warning light  comes on in grey to confirm the choice of LPG mode, then comes on in white or, depending on the vehicle, in green when LPG mode is active.

To switch from LPG mode to petrol mode manually

Press control **1**.

The  warning light goes out on the instrument panel **2** and indicates that petrol mode is activated.



To access the information and to reinitialise the LPG trip settings → **112**.



While the fuel tank is empty, the vehicle cannot start or drive in LPG mode only.

Operation using LPG/petrol bi-fuel requires the presence of petrol (for starting, high acceleration, cold temperatures, etc.).

If the orange  warning light appears on the instrument panel and a beep sounds, fill the tank with petrol as soon as possible.

Automatically switching from LPG mode to petrol mode

Depending on the vehicle, under certain conditions of use (e.g. starting when cold, hard acceleration, etc.), the

system may opt to temporarily switch back to petrol mode.

The  warning light appears in grey to warn you.

If the conditions are met again, it then automatically switches back to LPG

mode and the  warning light appears in white or, depending on the vehicle, in green.

Note: after several unfruitful attempts, the system may decide to remain in Petrol mode for the current journey.

A new attempt may be made after the engine has been fully stopped.

LPG tank empty

When the tank is almost empty and the engine is running on the LPG fuel reserve, the "LPG low level" message is displayed on the instrument panel accompanied by a beep and lighting up:

– of the  warning light in white or, depending on the vehicle, in green; and

– the  warning light in yellow.

LPG VEHICLE



Press switch **3** "OK", **4** or **5** to stop displaying the message and the warning lights.

When there is no LPG in the tank, the "LPG tank empty" message is displayed on the instrument panel accompanied by a beep and:

– the disappearance of the  warning light;
and

– the display of the  warning light in yellow.



Fill up the LPG as soon as possible
→ **34**.

Operating faults

In the event of a fault that could impair the correct operation of the engine, the "LPG not available" message appears and the system automatically switches from LPG mode to Petrol mode.

This is confirmed by the display of the following on the instrument panel:

– the "Check LPG system" message;
and

– the  warning light or, depending on the vehicle, the  warning light in yellow.

Contact your Approved Dealer as soon as possible.

If driving under severe conditions

In very cold weather (temperature below approximately 10 °C) and, depending on the quality of the gas used, the system may:

– automatically manage the conditions for switching between LPG mode and petrol mode;

or

– consume a small amount of petrol in LPG mode.

Note: on vehicles that are equipped, it is recommended to use ECO mode in these conditions (particularly below 0 °C)

to maximise the use of LPG mode
→ **192**.

In the event of an accident

The main precautions to be taken are the same as with petrol vehicles:

- apply the parking brake;
- stop the engine (a safety device that stops LPG from entering the engine is automatically triggered);
- switch off the ignition;
- observe local regulations.



LPG has a very specific smell so you will be able to detect any leaks easily. If you smell gas in your vehicle or around your vehicle:

- switch to petrol mode immediately and make sure that there are no flames or sources of fire near the vehicle;
- go to an authorised dealer.

LPG VEHICLE

2



Do not touch, hit or dismantle any part of the LPG system components.

LPG tank

Filling up with LPG

Useful capacity of LPG tank: approximately 8.80 gal (40 l) or 11.00 (50 l) (depending on the vehicle).

Apply the parking brake, stop the engine, switch off the ignition and switch off the lights.

Always observe the safety instructions given at filling stations.

Depending on the country, before refilling you must screw the filling adapter **1** on the LPG tank filler end piece.

It is always advisable to completely fill the tank.

When the pump stops delivering LPG, or when the pump flow reduces significantly, the maximum LPG level has been reached.

At this point, do not attempt to carry on filling.

Filling stations without self-service

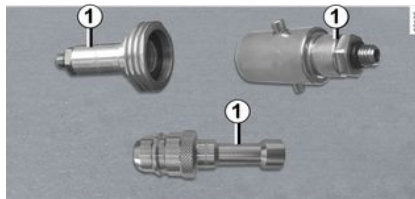

If the service station personnel carry out the LPG filling procedure, you must hand them the filling adapter **1**.



IMPORTANT: LPG filling adapter 1

Depending on the country, the use of a specific adapter is required for LPG filling.

The filling adapter **1** is provided in a pouch in the glove box. It may or may not be present in the vehicle, depending in which country the vehicle was sold.

Before driving the vehicle to another country, it is essential to consult an approved dealer to find out the type of adapter to use if necessary.

Filling stations with self-service



We recommend that you wear gloves when handling the LPG pistol.

Open your vehicle's fuel tank flap and unscrew the cap **2** from the LPG filler end piece.

Carefully follow the information explaining how to refill using the LPG distributor.

Depending on the type of station, it may be necessary to perform a long press of the station button before filling will start.

When the pump stops or if it has difficulty operating, this means that the maximum tank fill level (80%) has been reached.

LPG VEHICLE

The filling will stop as soon as you release the button. Release the stop lever (a small amount of gas may be released), lift the pistol and place it on the distributor.

After filling, refit the cap 2 to prevent any water or foreign bodies from entering the system.



To fill up with fuel, the engine must be stopped (and not only on standby in the case of vehicles equipped with the Stop and Start function): you must switch off the ignition → 162, → 164.
Fire hazard.

Fuses

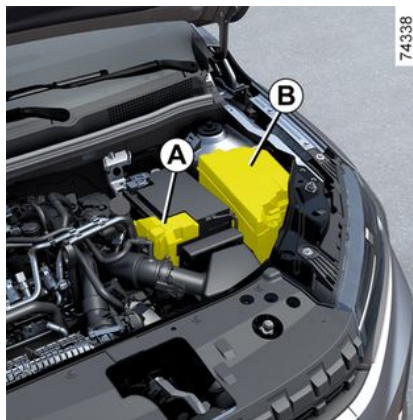

Fuses in the engine compartment A and B

Some functions are protected by fuses located in the engine compartment in boxes **A** and **B**.

However, because of their reduced accessibility, **we advise you to have your fuses replaced by an approved Dealer.**



To comply with current legislation, or as a precaution, you can obtain an emergency kit containing a set of spare bulbs and fuses from your approved Dealer.



Check the fuse in question and, **if necessary, replace it with a fuse that has the same rating as the original.**

If a fuse is fitted with too high a rating, it may cause the electrical circuit to overheat (risk of fire) in the event of an item of equipment using an excessive amount of current.



When working in the engine compartment, ensure that the windscreen wiper stalk is in the off position.
Risk of injury.

LPG VEHICLE

2



Before carrying out any operation in the engine compartment, you must switch off the ignition

→ 162, → 164.



Please note when working close to the engine that it may be hot. The engine cooling fan may also start at any moment. The



label in the engine compartment reminds you of this.

Risk of injury.

CARD

General information

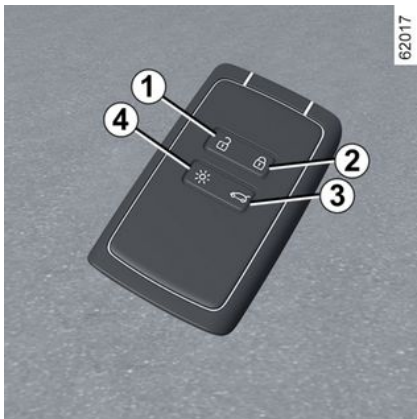

1. Unlocking the doors and luggage compartment.
2. Locks all the opening elements.
3. Unlocking the luggage compartment only.
4. Switching on the lighting remotely.

The card is used for:

- locking/unlocking the opening elements (doors, luggage compartment door);
- switching on the vehicle lighting remotely.

Range

Make sure that the correct battery type is being used, and that the battery is in good condition and inserted correctly. Its service life is approximately two years: it should be replaced when the "Keycard Battery Low" message appears on the instrument panel → 43.

card operating range

This varies according to the surroundings: take care not to accidentally lock or unlock the vehicle by inadvertently pressing the buttons on the card.

Note: if an opening element (door or luggage compartment door) is open or incorrectly shut, locking is unsuccessful and a beep is emitted.

Interference

Interference by factors in the immediate vicinity (external installations or the use of equipment operating on the same frequency as the card) may disrupt its operation.



If the battery is flat, you can still lock/unlock and start your vehicle → 51 → 164.

"Remote lighting" function

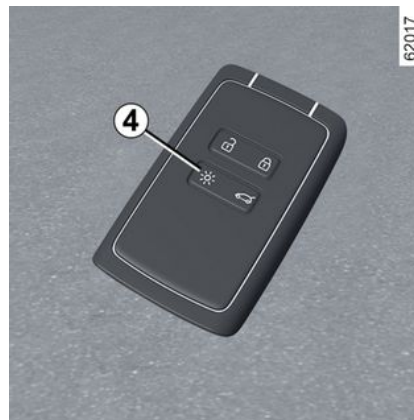

Press button 4 to switch on the interior lighting, the side lights and the dipped beam headlights for approximately 20 seconds. This can be used, for example, to identify your vehicle from a distance when parked in a car park.

Note: press button 4 again to switch off the lighting.

CARD



Recommendations

Avoid leaving the card in hot, cold or humid areas.

Do not keep the card in a place where it could be bent or damaged accidentally, such as in your back pocket.



Replacement: need for an additional card

If you lose your card or require another, you can obtain one from an approved Dealer.

If a card is replaced, it will be necessary to take the vehicle **and all its cards** to an approved Dealer to re-set the system.

You may use up to four cards per vehicle.



Driver's responsibility when parking or stopping the vehicle

Never leave an animal, child or adult who is not self-sufficient alone in your vehicle, even for a short time.

They may pose a risk to themselves or to others by starting the engine, activating equipment such as the electric windows or by locking the doors.

Also, in hot and/or sunny weather, please remember that the temperature inside the passenger compartment increases very quickly.

RISK OF DEATH OR SERIOUS INJURY.

Fitting a strap 7

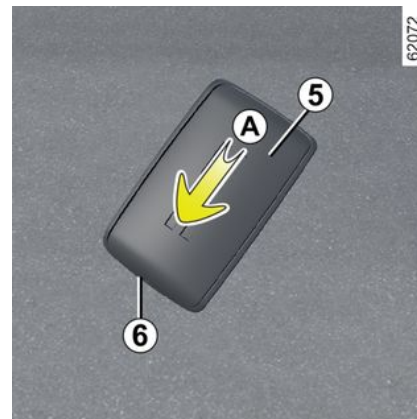

Slide the rear casing **5** downwards while pressing on area **A**.



Never insert screwdriver-type tools into the opening **6**.

CARD

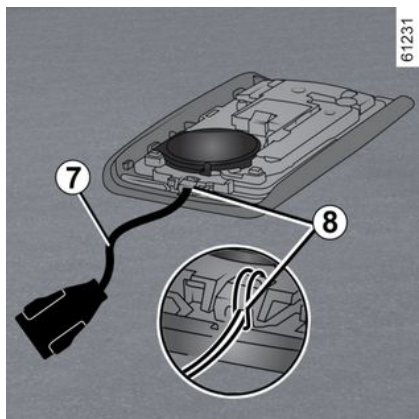

Insert the hand strap into the component **8** and pass the end of the strap through the buckle.

Position the strap at the opening **6** and close the casing.

Note: check that the diameter of the hand strap cord **7** fits the opening **6**.

Use

There are two ways to unlock/lock the vehicle:

- in "hands-free" mode, when approaching and moving away from the vehicle;
- using the card in remote control mode.



Do not store the card anywhere it may come into contact with other electronic equipment (computer, phone etc.) as this could hinder its operation.

Deactivating/activating the "hands-free" mode

Depending on the vehicle, you can deactivate/activate unlocking when approaching and locking when moving away from the vehicle.

You can also deactivate/activate the sound signal that is emitted upon locking when moving away from the vehicle ➔ **128**.



Never leave your vehicle with the card inside.



Driver's responsibility when parking or stopping the vehicle

Never leave an animal, child or adult who is not self-sufficient alone in your vehicle, even for a short time.

They may pose a risk to themselves or to others by starting the engine, activating equipment such as the electric windows or by locking the doors.

Also, in hot and/or sunny weather, please remember that the temperature inside the passenger compartment increases very quickly.

RISK OF DEATH OR SERIOUS INJURY.

CARD

Using the card in "hands-free" mode

2



67810

In "hands-free" mode, it is possible to lock/unlock the vehicle without using any of the buttons on the card, as long as the card is within the access zone **1**.

Note: if the vehicle has not been used for more than eight days, the "hands-free" system switches to standby. To reactivate it, press the unlocking button on the card.

"Hands-free" unlocking when approaching the vehicle

With the card in the access zone **1**, the vehicle will unlock.

Unlocking is indicated by **one flash** of the hazard warning lights and the indicator lights.

"Hands-free" locking when moving away from the vehicle

With the card on you and the doors and luggage compartment door closed, move away from the vehicle: it will be locked automatically as soon as you leave the access zone **1**.

Note: the distance at which the vehicle locks depends on the surroundings.

The indicator lights and hazard warning lights **flash twice** to indicate that the doors have locked.

The locking is confirmed by a beep.

Special features of the unlocking system

After eight days of non-use, approach unlocking is disabled.

Use the card as a remote control to unlock the vehicle and reactivate the mode.

Special features of the locking system

If a door is open or not properly closed, when you go away, the vehicle is not locked.

Special features relating to "hands-free" locking



67810

After locking in "hands-free" mode, you have to wait approximately three seconds to be able to unlock the vehicle again. During these three seconds, the door handles can be tried to make sure that the vehicle is locked properly.

CARD



67811

If the card has been within the detection zone **1** for approximately 15 minutes, remote locking is deactivated. To lock the vehicle, press the button **4** on the card.

The vehicle cannot be locked if the card is within the zone **2**. If the vehicle is unlocked by pressing the button on the card, but the doors or luggage compartment are not then opened, remote "hands-free" locking is disabled.



Driver's responsibility when parking or stopping the vehicle

Never leave an animal, child or adult who is not self-sufficient alone in your vehicle, even for a short time.

They may pose a risk to themselves or to others by starting the engine, activating equipment such as the electric windows or locking the doors.

Also, in hot and/or sunny weather, please remember that the temperature inside the passenger compartment increases very quickly.

RISK OF DEATH OR SERIOUS INJURY.

Using the card as a remote control

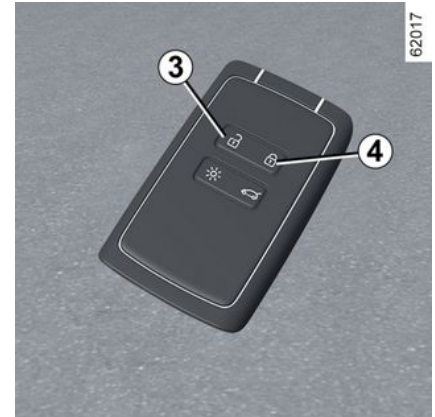

62017

2

Unlocking with the card

Press the button **3**.

Unlocking is indicated by **one flash** of the hazard warning lights and the indicator lights.

If an attempt is then made at trying to open a door by pressing the handle at the same time as the doors are unlocked remotely, the door concerned will remain locked. To rectify this, release the handle and unlock the vehicle again by pressing the button **3** on the card.

Locking using the card

With the doors and luggage compartment door closed, press button **4**: the

CARD

vehicle will be locked. The indicator lights and hazard warning lights **flash twice** to indicate that the doors have locked.

Note: the maximum distance from which the vehicle can be locked depends on the surroundings.

Special features

The vehicle cannot be locked if one of the opening elements (door or luggage compartment) is open or not properly shut, and a beep sounds.



The card buttons are deactivated when the engine is running.



67811

With the engine running, if a door is opened and closed and the card is no longer in zone **2**, the "Keycard Not Detected" message indicates that the card is not inside the vehicle. This will, for example, prevent you from driving away after dropping off a passenger who has kept the card on them.

The warning disappears when the card is detected again.

Unlocking/locking the luggage compartment only

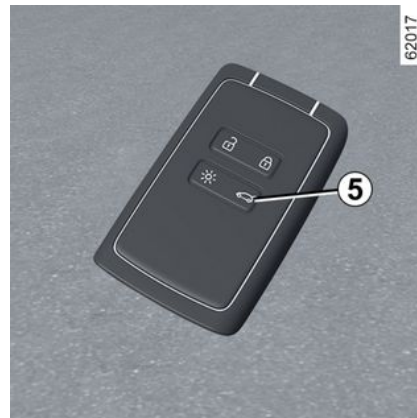

62017

Press and hold button **5**. The luggage compartment opens slightly and, depending on the vehicle, the tailgate fully opens automatically.

Note: after unlocking the luggage compartment only using button **5**, to unlock the other opening elements it is necessary:

– to press button **3**;

or

– to move away from the vehicle in order to activate the automatic locking when moving away from the vehicle. In this case, unlocking when approaching the vehicle will be functional again.

CARD



Driver's responsibility when parking or stopping the vehicle

Never leave an animal, child or adult who is not self-sufficient alone in your vehicle, even for a short time.

They may pose a risk to themselves or to others by starting the engine, activating equipment such as the electric windows or locking the doors.

Also, in hot and/or sunny weather, please remember that the temperature inside the passenger compartment increases very quickly.

RISK OF DEATH OR SERIOUS INJURY.

"Hands-free" card: battery

Replacing the battery

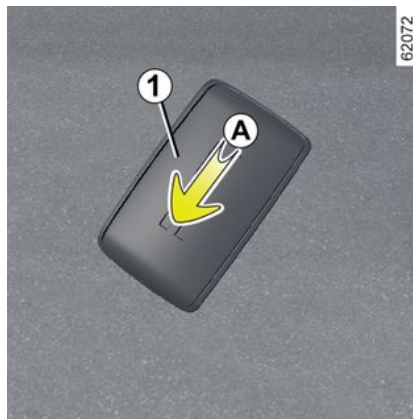

When the "Keycard Battery Low" message appears on the instrument panel, replace the card battery:

- slide the rear casing **1** downwards while pressing on area **A**;
- in area **B**, remove the cover **2** from the battery **3** by lifting upwards;
- remove the battery by pressing on one side and lifting the other;
- replace it according to the direction and template shown inside the cover.

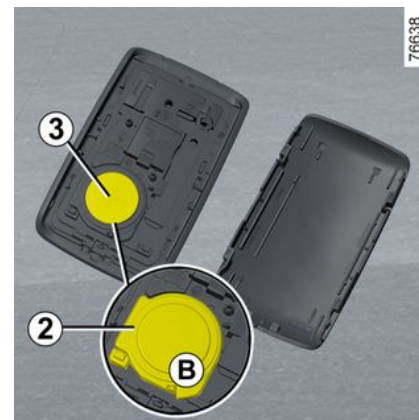

To refit, proceed in the reverse order then press one of the buttons on the card four times while you are near the vehicle: the next time the vehicle is started, the message will disappear.

Check that the cover is clipped shut.

Note: when replacing the battery, do not touch the electronic circuit or contacts on the card.

Operating faults

If the battery is too weak to ensure correct operation, you will still be able to start and lock/unlock the vehicle → 51.

2

CARD

2



When replacing:
– make sure that the batteries are correctly inserted.

Risk of explosion.

– if the flap does not close correctly, do not use and keep out of reach of children.



When they need to be replaced, be sure to use the same or equivalent type of battery (consult an Approved Dealer).



Precautions relating to batteries:

– keep batteries (new or used) out of reach of children;
– do not swallow batteries;

Risk of chemical burns which may prove fatal.

– if ingested or inserted into any part of the body, consult a doctor as soon as possible.



The batteries are available from approved Dealers, and their service life approximately two years. Check that there is no dye on the battery: risk of an incorrect electrical contact.

26913



Do not throw away your used batteries; give them to an organisation responsible for collecting and recycling batteries.

KEY, REMOTE CONTROL

General information

Depending on the vehicle, there are three types of keys: key **A**, **B** or **C**.

Key A

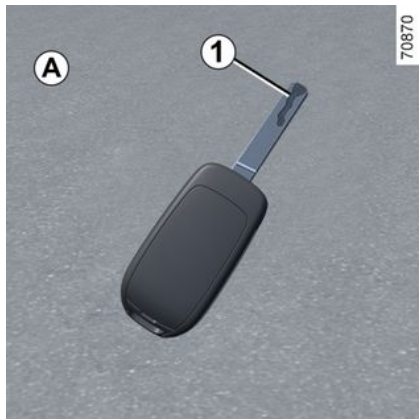

1. Coded key for starter ignition switch, doors, fuel filler cap and, depending on the vehicle, the luggage compartment only.

Radio frequency remote control B

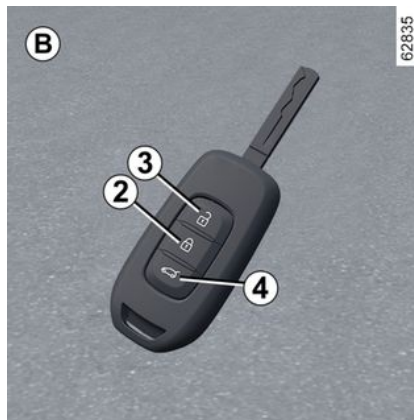

- 2.** Locks all the opening elements.
- 3.** Unlocking the doors and luggage compartment.
- 4.** Unlocking/locking the luggage compartment only.

Key C

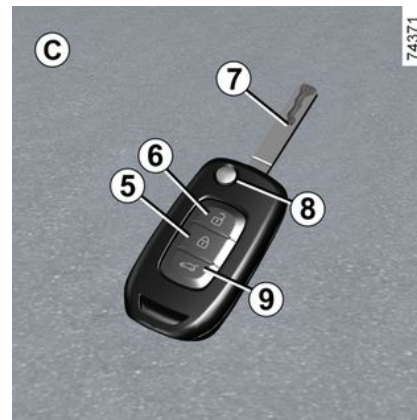

Key, remote control C

- 5.** Locks all the opening elements.
- 6.** Unlocking the doors and luggage compartment.
- 7.** Driver's door and ignition key.
- 8.** Locking/unlocking using the switchblade key. To release the insert from its housing, press the button **8** and it will come out. Press the button **8** and guide the insert back into its housing.
- 9.** Unlocking/locking the luggage compartment only.

KEY, REMOTE CONTROL



The key must not be used for any function other than those described in the handbook (removing the cap from a bottle, etc.).



Driver's responsibility when parking or stopping the vehicle

Never leave an animal, child or adult who is not self-sufficient alone in your vehicle, even for a short time.

They may pose a risk to themselves or to others by starting the engine, activating equipment such as the electric windows or by locking the doors.

Also, in hot and/or sunny weather, please remember that the temperature inside the passenger compartment increases very quickly.

RISK OF DEATH OR SERIOUS INJURY.

Radio frequency remote control operating range

This varies according to the environment: take care not to lock or unlock the doors accidentally by inadvertently pressing the buttons on the remote control.

Note: if a door or the luggage compartment door is open or not properly shut, the vehicle will not be locked. A beep sounds and the hazard warning lights and side repeaters do not flash.

Interference

Interference by factors in the immediate vicinity (external installations or the use of equipment operating on the same frequency as the remote control) may affect the operation of the remote control.



Recommendations

Avoid leaving the remote control in hot, cold or humid areas.



Replacement and additional keys or remote controls

If you lose your remote control key or require another, you can obtain one from an approved dealer.

If a remote control or key is replaced, it will be necessary to take the vehicle **and all of its remote control keys** to an authorised dealer to reset them.

You may use up to four remote control keys per vehicle.

Remote control key failure

Always make sure that the correct battery type is being used, and that the battery is in good condition and inserted correctly. These batteries should have a service life of approximately two years. How to change the battery ➔ 48.

KEY, REMOTE CONTROL

Use

Locking the doors



Press locking button **1**.

The hazard warning lights and side indicator lights **flash twice** to indicate that the doors have locked.

If any opening element (door or tailgate) is open or incorrectly shut, locking is unsuccessful and the hazard warning lights and side repeaters do not **flash**.

Unlocking the doors

Press unlocking button **2**.

The hazard warning lights and side indicator lights **flash once** to indicate that the doors have unlocked.

Note: if a door is not opened within approximately 2 minutes of the door being unlocked by the remote control, the doors will lock again automatically.

Unlocking the luggage compartment only

Press and hold button **3** to unlock the luggage compartment.

Note: depending on the vehicle, the tailgate fully opens automatically.



The key must not be used for any function other than those described in the handbook (removing the cap from a bottle, etc.).



Driver's responsibility when parking or stopping the vehicle

Never leave an animal, child or adult who is not self-sufficient alone in your vehicle, even for a short time.

They may pose a risk to themselves or to others by starting the engine, activating equipment such as the electric windows or by locking the doors.

Also, in hot and/or sunny weather, please remember that the temperature inside the passenger compartment increases very quickly.

RISK OF DEATH OR SERIOUS INJURY.

KEY, REMOTE CONTROL

Radio frequency remote control: battery

2 Replacing the battery

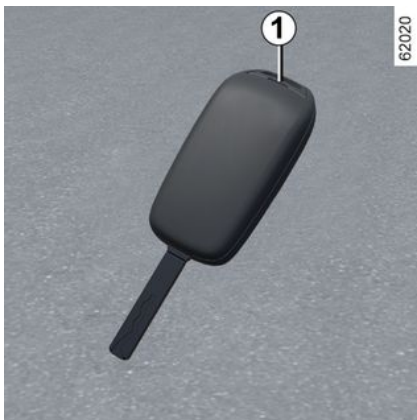

Open the cover via slot **1** using a flat-blade screwdriver or similar tool and replace the battery **2**, observing the type and polarity shown on the back of the cover.



If they need to be replaced, be sure to use the same or equivalent type of battery (consult an Approved Dealer).



Note: it is not advisable to touch the electronic circuit in the key cover when replacing the battery.

Ensure that the cover is correctly clipped on and the screw tightened.



The batteries are available from approved Dealers, and their service life approximately two years. Check that there is no dye on the battery: risk of an incorrect electrical contact.

Operating faults

If the battery is too weak to ensure correct operation, you will still be able to start and lock/unlock the vehicle → 51.

26913



When replacing:

– make sure that the batteries are correctly inserted.

Risk of explosion.

– if the flap does not close correctly, do not use and keep out of reach of children.

KEY, REMOTE CONTROL



Precautions relating to batteries:

- keep batteries (new or used) out of reach of children;
- do not swallow batteries;

Risk of chemical burns which may prove fatal.

- if ingested or inserted into any part of the body, consult a doctor as soon as possible.



Do not throw away your used batteries; give them to an organisation responsible for collecting and recycling batteries.

DOORS AND OPENING ELEMENTS

Opening and closing the doors

Opening from the outside



With the doors unlocked, place your hand under the handle **1** and pull it towards you → **51**.

Opening from the inside



Pull the handle **2**.



As a safety precaution, the doors should only be opened/closed when the vehicle is stationary.

Lights-on reminder audible alarm

If you have left the lights on after switching off the ignition, a reminder buzzer will sound when the driver's door is opened.

Door or luggage compartment lid open buzzer

Depending on the vehicle, this alarm is fitted to the driver's side door or on all opening elements.

With the vehicle at a standstill, a warn-

ing light  will come on if a door or the boot is open or not properly closed.

While driving, as soon as the vehicle reaches 12 mph (20 km/h), a warning

light  comes on with an audio beep.

Special feature

Depending on the vehicle, accessories (e.g. radio) stop working either when the engine is switched off or when the doors are locked.

DOORS AND OPENING ELEMENTS

Child safety



To make it impossible for the rear doors to be opened from the inside, move lever **3** on each door and check from the inside that the doors are securely locked.



Driver's responsibility when parking or stopping the vehicle

Never leave an animal, child or adult who is not self-sufficient alone in your vehicle, even for a short time.

They may pose a risk to themselves or to others by starting the engine, activating equipment such as the electric windows or by locking the doors.

Also, in hot and/or sunny weather, please remember that the temperature inside the passenger compartment increases very quickly.

RISK OF DEATH OR SERIOUS INJURY.

Locking, unlocking the opening elements and doors

If the remote control or, depending on the vehicle, the card does not work

In some cases, the radio frequency remote control or the card may not work:

- card or radio frequency remote control battery worn or run flat, vehicle battery flat etc.
- use of appliances operating on the same frequency as the card (mobile phone, etc.);
- the vehicle is located in a high electromagnetic radiation zone.

It is then possible:

- to use the radio frequency remote control or the emergency key integrated into the card (depending on the vehicle) to unlock the driver's door;
- to lock each of the doors manually;
- to use the interior door locking/unlocking control;

The card's built-in key

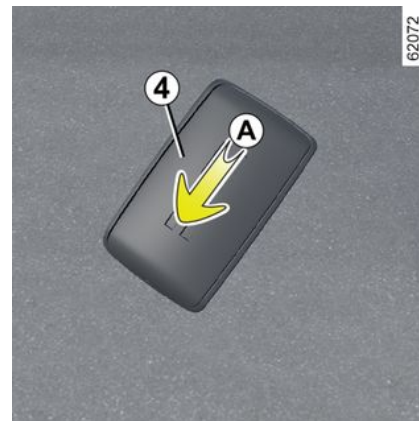

DOORS AND OPENING ELEMENTS

The built-in key **5** is used to lock or unlock the front left-hand door if the card is not working.

2

Accessing the key **5**

Slide the rear casing **4** downwards while pressing on area **A**.



Using the key integrated in the card

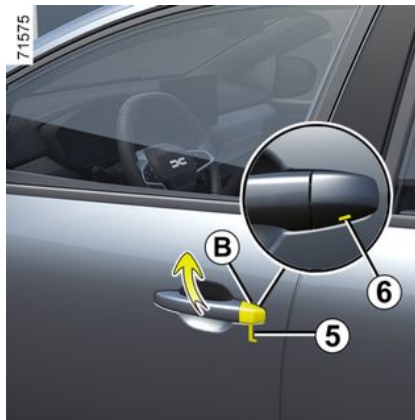

- Insert the end of the key **5** into the notch **6** at the bottom of the cover **B** on the driver's door;
- move it upwards to remove the cover **B**;
- insert the key **5** into the lock of the driver's door, then lock or unlock.

Once you are inside the vehicle, put the key back in its casing in the card.

Vehicles with key, remote control

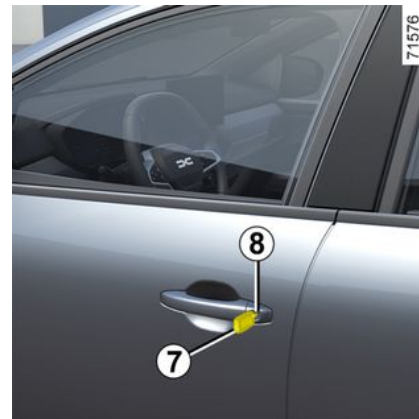

Using the key

Insert the key **7** into the lock of the driver's door **8**, lock and unlock.

DOORS AND OPENING ELEMENTS

Locking the doors manually



With the door open, turn the lever **9** (using the end of the key) and close the door.

This means that the door is then locked from the outside.

The doors may then only be opened from the inside or by using the key in the driver's door.



From the inside

(depending on the vehicle)

Push in the button **10** to lock or raise the button **10** to unlock.



Driver's responsibility

If you decide to keep the doors locked when you are driving, remember that it may be more difficult for those assisting you to gain access to the passenger compartment in the event of an emergency.

Interior locking/unlocking door control



Depending on the vehicle, it can be used to simultaneously lock or unlock the four side doors and the tailgate. Lock or unlock the doors by pressing switch **11**.

If a door or the tailgate is open or not closed properly, the doors and tailgate lock/unlock quickly.

If transporting an object with the luggage compartment open, you can still lock the other doors: with the engine stopped, press and hold switch **11** for more than five seconds to lock the doors.

DOORS AND OPENING ELEMENTS

Door and tailgate status indicator

(depending on the vehicle)

With the ignition on, the warning light above switch **11** lights up and informs you of the opening element locking status:

- when the warning light is on, the doors and luggage compartment door are locked;
- indicator light off, the doors and tailgate are unlocked.

When you lock the doors, the indicator light remains lit and then goes out.

Locking the opening elements without the card or the key

For example, in the event of a discharged battery or the card or key temporarily not working etc.

With the engine stopped and a door or the luggage compartment door open, press and hold the switch **11** for more than five seconds.

When the door is closed, all the doors and tailgate will be locked.

Unlocking the vehicle from the outside is only possible with the card in the vehicle access zone or by using the key.



Never leave your vehicle with the key or card inside.

Automatic locking when driving

Operating principle



After the vehicle is started, the system automatically locks the doors when you reach approximately 6 mph (10 km/h).

The door can be unlocked:

- by pressing the door unlocking switch **11**;
- at a standstill, by opening a front door from inside the vehicle.

Note: if a door is opened/closed, it will automatically lock again when the vehicle reaches a speed of approximately 6 mph (10 km/h).

Activating/deactivating the function

To activate it: with the vehicle stationary and the engine on, press the switch **11** until a beep sounds.

To deactivate it: with the vehicle stationary and the engine on, press the switch **11** until you hear two beeps.

Operating faults

If you notice an operating fault (automatic locking impossible), check that all doors are properly shut. If they are properly closed and the fault is still present, contact an approved Dealer.

Also make sure that locking has not been inadvertently deactivated.

If this is the case, reactivate it.

DOORS AND OPENING ELEMENTS



Driver's responsibility

If you decide to keep the doors locked when you are driving, remember that it may be more difficult for those assisting you to gain access to the passenger compartment in the event of an emergency.

Luggage compartment

To open

Electric central locking



With the doors unlocked, press the **12** button or, depending on the vehicle, press the **13** button (on the key or card) and the tailgate fully opens automatically.

Note: before opening the tailgate, ensure that there is sufficient space around to allow the tailgate to open.

Note: in very cold weather conditions, the automatic opening may not work if the tailgate seals are frozen.



When opening/closing the tailgate, ensure that nothing obstructs the manoeuvre.



When opening the tailgate, ensure that nobody is close to the moving parts.

Risk of injury.



As a safety precaution, the doors should only be opened/closed when the vehicle is stationary.

Risk of injury.



It is prohibited to attach any carrying device (bicycle rack, cargo box, etc.) resting on the tailgate. To install a carrying device on your vehicle, contact an approved Dealer.

DOORS AND OPENING ELEMENTS

To close

2



Lower the tailgate, first using the inside handle **14** if fitted to the vehicle.



Never handle the struts when closing the tailgate.

FRONT SEATS

Front headrests

To raise the headrest A

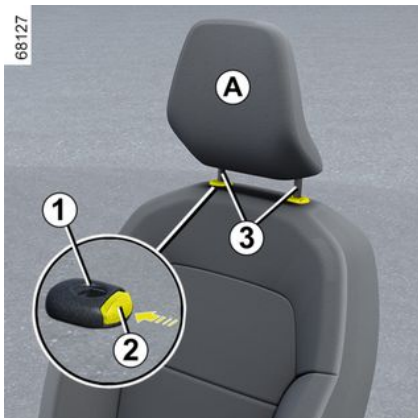

Pull the headrest upwards to the desired height. Check that it is correctly locked.

To lower the headrest

Press the button **2** and guide the headrest down to the desired height. Check that it is correctly locked.

To remove the headrest

Raise it to its highest position (tilt the seatback backwards if necessary).

Press the button **2** and lift the headrest to release it.

To refit the headrest

Check that the headrest rods are clean **3**.

Insert the headrest rods into the holes **1** (tilt the seatback backwards if necessary). Lower the headrest until it locks and press button **2** to adjust to the desired height. Check that each rod **3** is locked on the seatback.

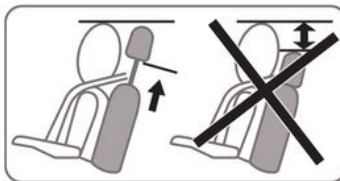

The headrest is an important safety component: ensure that it is in place and in the correct position. The top of your head should be in line with the top of the headrest. The distance between your head and section **A** should be as short as possible.

2

Front seats

Settings



To move the seat forwards or back

FRONT SEATS

Lift and hold the handle **1** to unlock the seat. Release the handle at the desired position and make sure that it is locked.

To raise or lower the seat base

(depending on the vehicle)

Move the lever **2** as many times as necessary upwards or downwards until the required position is reached.

To tilt the seatback

Lift handle **3** and tilt the seatback to the desired position. Release the handle at the desired position and make sure that it is locked.

Heated seats

(depending on the vehicle)

Ignition on:

- a first press on the switch **4** for the seat concerned activates the heating system at maximum power. Both of the built-in warning lights on the switch light up;
- a second press decreases the heating to minimum power. One integrated warning light is illuminated;
- pressing for the third time turns the heating off.

The system automatically regulates the seat temperature. When activated, it will determine if the seat heating is necessary or not.



After making adjustments, make sure that the seatbacks are correctly locked in place.



For safety reasons, carry out any adjustments while the vehicle is stationary.

We would advise you not to recline the seatbacks too far to ensure that the effectiveness of the seat belts is not reduced. Nothing should be placed on the floor (area in front of the driver) as these objects may slide under the pedals during sudden braking manoeuvres, thus obstructing their use.

REAR SEATS

Rear headrests

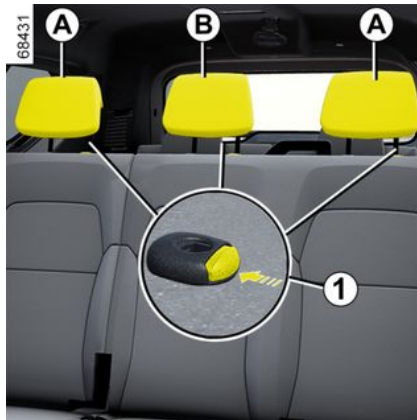

Removing the headrests **A** or **B**

Raise the headrest as far as it will go, then press button **1** and remove the headrest.

Adjusting the height of the headrest **B**

(depending on the vehicle)

Press the button **1** and simultaneously slide the headrest to the desired height.

Refitting the headrests **A** or **B**

Insert the rods in the holes, press button **1**, lower the headrest and check that it is securely in place.

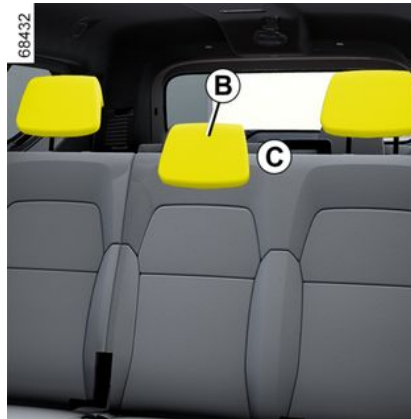

Headrest in use position **B**

(depending on the vehicle)

Lift the headrest fully until it locks. Check that it is correctly locked.

Storage position for the headrest **B**

(depending on the vehicle)

Press button **1** and lower the headrest completely.



The lowest position of the headrest (position C) is for storage only: do not set it in this position when the seat is occupied.



The headrest is a safety component, check that it is fitted and in the correct position.

REAR SEATS

2nd row rear seats



To fold down the seat *A* or the bench seat *B*

- Bring the front seats forward;
- make sure all seat belts are unfastened and place them in their guides **1**;
- lower the headrests → **59**;
- pull on tab **2**;
- lower the seatback onto the seat base;
- raise the seat until it is vertical.



When moving the rear seats, check that the anchoring points are clean (they must be free from grit, cloths, toys etc.).



Check that the rear seat belts are positioned and operating correctly each time the rear bench seat is moved.



To reposition the seat *A* or the bench seat *B*

- Lower the bench seat until it locks in position;
- fold the seatbacks up again;
- make sure that the seat bases and seatbacks lock into position correctly.



For safety reasons, carry out any adjustments while the vehicle is stationary.

REAR SEATS

Restriction of use



If a passenger is occupying one of the second row seats, do not drive with the other second row seat folded down.

Risk of injury.



To avoid all risk of injury, ensure that nobody is in the proximity of the moving parts.



Make sure that the seatback is correctly locked. If necessary, remove any obstacles behind the seats. Repeat the procedure until the seat is correctly locked.



When refitting the seatback, make sure it is correctly locked in place.

If seat covers are fitted, make sure these do not prevent the seatback latch from locking in.

Make sure that the seat belts are positioned correctly. Reposition the headrests.

3rd row rear seats

Accessing the third row rear seats



– From the second row, pull the tab **1**;

- lower the seatback onto the seat base;
- raise the seat until it is vertical.

To put the seat back into its initial position, perform the same procedure in reverse.



To avoid all risk of injury, ensure that nobody is in the proximity of the moving parts.

REAR SEATS

2



Make sure that the seat-back is correctly locked. If necessary, remove any obstacles behind the seats. Repeat the procedure until the seat is correctly locked.



When refitting the seat-back, make sure it is correctly locked in place. **If seat covers are fitted**, make sure these do not prevent the seatback latch from locking in. Make sure that the seat belts are positioned correctly. Reposition the headrests.

Use restrictions

A



B

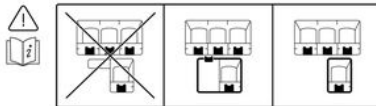

It is not permitted to drive with one of the seat backs or a second row seat folded down if a passenger is in one of the third row seats. The label **A** is affixed in the vehicle as a reminder. **Risk of injury.**



It is not permitted to drive with one of the third row seats folded down if a passenger is in the other third row seat. The label **B** is affixed in the vehicle as a reminder. **Risk of injury.**

The third row rear seats can be folded down or removed for transporting bulky objects.



For safety reasons, carry out any adjustments while the vehicle is stationary.

To fold down the seats



- Ensure that the rear seat belts are correctly positioned on the hooks **2**;
- lower the headrests → **59**;
- unlock the controls **3**, press on the middle of the seat backs and lower the seatbacks onto the base;

REAR SEATS

– pull the straps **4** to release the seats and raise the seat base until it is vertical.

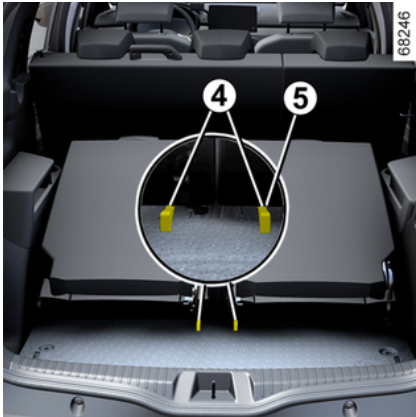

Ensure that each strap **4** is securely fixed in its ring **5**.
Risk of damage.

To reposition the seats

- Ensure that the rear seat belts are correctly positioned on the hooks **2**;
- lower the seat base until it locks in position;
- unlock the controls **3** while pressing on the top of each seatback and raise the seatbacks;
- make sure that the seat base and seatbacks lock into position correctly.



No person or animal should be on the third row rear seats if the luggage compartment cover is not removed.



Check that the rear seat belts are positioned and operating correctly each time the rear bench seat is moved.



When moving the rear seats, check that the anchoring points are clean (they must be free from grit, clothes, toys, etc.)

To remove the seats



- Ensure that the rear seat belts are correctly positioned on the hooks **2**;
- **fold down the second row seats** → **60**;
- lower the headrests → **59**;

REAR SEATS

2



- unlock the controls **3** press on the middle of the seat backs and lower the seatbacks onto the base;
- pull the straps **4** to release the seats and raise the seat base until it is vertical;

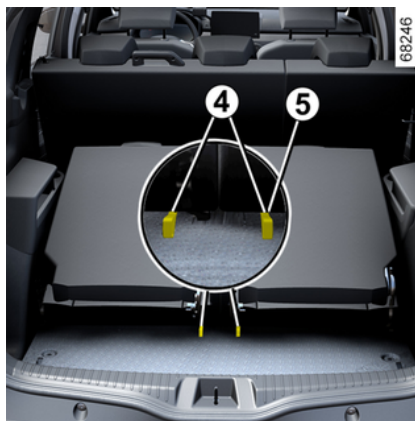

 Ensure that each strap **4** is securely fixed in its ring **5**.
Risk of damage.

- unlock controls **6**;
- lift the seats in order to remove them using the rear side doors. You can then remove them from the vehicle.



Check that the rear seat belts are positioned and operating correctly each time the rear bench seat is moved.

REAR SEATS

To install seats



- Ensure that the rear seat belts are correctly positioned on the hooks **2**;
- **fold down the second row seats** → **60**;
- reposition the seats in relation to the hooks **7** on the floor via the rear side doors;
- lower the seat base until it locks in position;



- unlock the controls **3** while pressing on the top of each seatback and raise the seatbacks;
- make sure that the seat base and seatbacks lock into position correctly.



When moving the rear seats, check that the anchoring points are clean (they must be free from grit, cloths, toys, etc.)

SEAT BELTS

Seat belts

Always wear your seat belt when travelling in your vehicle. You must also comply with the legislation of the particular country you are in.

Before starting, first adjust your driving position, then ask all occupants to adjust their seat belts to ensure optimum protection.

Adjusting your driving position

- **Sit well back in your seat** (having removed your coat or jacket, etc.). This is essential to ensure that your back is positioned correctly;
- **adjust the distance between the seat and the pedals.** Your seat should be as far back as possible while still allowing you to fully depress the pedals. The seatback should be adjusted so that your arms are slightly bent when you hold the steering wheel;
- **adjust the position of your headrest.** For maximum safety, your head must be as close as possible to the headrest;
- **adjust the height of the seat.** This adjustment allows you to select the seat position which offers you the best possible view;
- **adjust the position of the steering wheel.**



Make sure that the rear seats → 60 → 61 are locked in position properly so that the rear seat belts will operate efficiently.



Incorrectly adjusted or twisted seat belts may cause injuries in the event of an accident.

Use one seat belt per person, whether child or adult.

Even pregnant women should wear a seat belt. In this case, ensure that the lap belt is not exerting too much pressure on the abdomen, but do not allow any slack.

Adjusting the seat belts

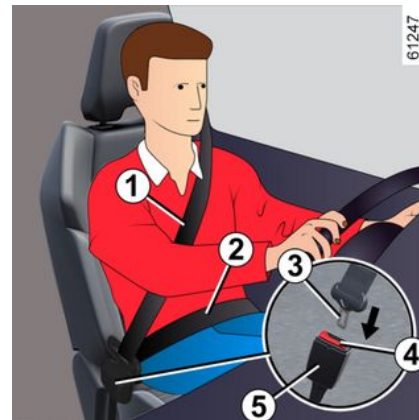

To ensure the correct adjustment and positioning of the seat belts on all seats:

- adjust the seats (seat position and seatback angle, if available);
- sit with your back firmly against the seatback;
- move the shoulder strap **1** as close as possible to the base of the neck without it actually resting against it (if necessary, adjust the height of the seat belt if possible) and make sure that the shoulder strap **1** is in contact with the shoulder;
- position the lap belt **2** so that it lies flat on the thighs and against the pelvis.

SEAT BELTS

The seat belt must be worn as close to the body as possible. e.g. avoid wearing clothing that is too thick, objects that might get in the way, etc.).

Locking

Unwind the belt **slowly and smoothly** and ensure that the buckle **3** locks into the catch **5** (check that it is locked by pulling on the buckle **3**).

If the belt jams, allow it to return slightly before attempting to unwind it again.

If your seat belt is completely jammed, pull slowly, but firmly, so that just over 3 cm unwinds. Allow it to return slightly before attempting to unwind it again.

If there is still a problem, contact an approved dealer.

Unlocking

Press the button **4** and the seat belt will be rewound by the inertia reel. Guide the belt.



Seat belt reminder warning light



This warning light appears on the central display **A** when the ignition is switched on and if the driver's and/or front passenger and/or rear passenger seat belt(s) (if the seat is occupied) is not fastened.



Front and rear seat belt reminder warning



With the doors closed, the graphic **6** is displayed on the instrument panel for approximately 60 seconds when the vehicle ignition is switched on. This informs the driver of the fastening status of each of the seat belts every time:

- the doors are opened during driving (vehicle speed above zero);
- a seat belt is fastened/unfastened.

Understanding the graphic 6:

-  seat belt fastened;
-  seat occupied and seat belt unfastened;

SEAT BELTS

2

–  seat not occupied.

With the doors closed, the  warning light appears on the central display when the vehicle ignition is switched on if the driver's and/or passenger's seat belt(s) (if this seat is occupied) are not fastened.

When the vehicle speed is less than approximately 12 mph (20 km/h), the

 warning light appears on the central display if a seat is occupied and the seat belt is not fastened. It is accompanied by the graphic **6** which appears for approximately 60 seconds each time one of the seat belts is fastened or unfastened.

When the vehicle speed reaches or exceeds 12 mph (20 km/h), if one of the seat belts is or becomes unfastened during the journey:

– the  warning light flashes on the central display;

and

– a beep sound for approximately 120 seconds;

and

– the graphic **6** is displayed for approximately 180 seconds and the

 symbol appears for the seat concerned.

Always make sure that the passengers are properly fastened in and that the number of seat belts indicated as fastened corresponds to the number of seats occupied.

Note: in some cases, the warnings may be triggered if an object is placed on one of the seats.



73108

With the doors closed, the graphic **7** is displayed on the instrument panel for approximately 60 seconds when the vehicle ignition is switched on. This informs the driver of the fastening status of each of the seat belts every time:

- the doors are opened during driving (vehicle speed above zero);
- a seat belt is fastened/unfastened.

Understanding the graphic 7:

- symbol in green: seat belt fastened;
- symbol in red: the seat is occupied and the seat belt is not fastened;
- symbol in grey: seat not occupied.

With the doors closed, the  warning light appears on the central display when the vehicle ignition is switched on if the driver's and/or passenger's seat belt(s) (if this seat is occupied) are not fastened.

When the vehicle speed is less than approximately 12 mph (20 km/h), the

 warning light appears on the central display if a seat is occupied and the seat belt is not fastened. It is accompanied by the graphic **7** which appears for approximately 60 seconds each time one of the seat belts is fastened or unfastened.

When the vehicle speed reaches or exceeds 12 mph (20 km/h), if one of the seat belts is or becomes unfastened during the journey:

– the  warning light flashes on the central display;

and

SEAT BELTS

– a beep sound for approximately 120 seconds;

and

– the graphic **7** is displayed for approximately 180 seconds and the symbol for the seat concerned appears in red.

Always make sure that the passengers are properly fastened in and that the number of seat belts indicated as fastened corresponds to the number of seats occupied.

Note: in some cases, the warnings may be triggered if an object is placed on one of the seats.

Rear seat belts

Estate version second row rear seats

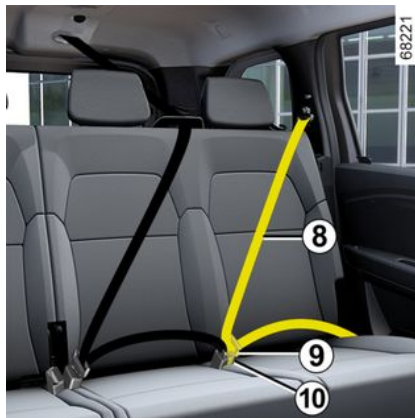

Rear side seat belts

Slowly unwind the belt **8** and click the buckle **9** into the red catch **10**.

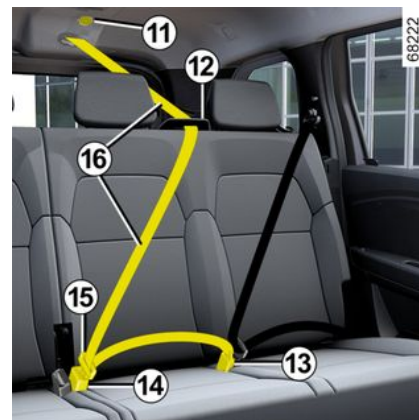

Rear centre seat belt

Unwind belt **16** slowly from its housing **11**.

Pass the two buckles and the belt **16** in the belt guide **12**.

Click the smaller fixed buckle into the catch with the black locking button **13**.

Click the larger sliding buckle **15** into the catch with the red unlocking button **14**.



Rear seat functions → **60**
→ **61**.

SEAT BELTS

2



Check that the rear seat belts are positioned and operating correctly each time the rear seats are moved.

Estate version third row rear seats



Detach the belt **17** from the hook **20**. Slowly unwind the belt **17**.

Click the sliding seat belt buckle **18** into the corresponding catch with the red unlocking button **19**.



i When handling the third-row rear seats, the seat belt strap **17** must always be fastened to hook **20** to prevent damage to the strap or the luggage compartment cover (if fitted to the vehicle).

i Rear seat functions → **60**
→ **61**.

SEAT BELTS

Warnings

The following information applies to the vehicle's front and rear seat belts.



- No modification must be made to the originally-fitted restraint system components (seat belts, seats and their mountings). For special operations (e.g. fitting a child seat), please contact an approved dealer.
- Do not use devices which give any slack in the belts (e.g. clothes pegs, clips, etc.), as a seat belt which is worn too loosely risks causing injury in the event of an accident.
- Never wear the shoulder strap under your arm or behind your back.
- Never use the same belt for more than one person and never hold a baby or child on your lap with your seat belt around them.
- The belt should never be twisted.
- Following an accident, have the seat belts checked and replaced if necessary. Always replace your seat belts as soon as they show any signs of wear.
- When the rear bench seat is being put back, make sure that the seat belts and buckles are correctly positioned so that they can be used properly.
- Make sure that the seat belt buckle is inserted into the appropriate catch.
- Ensure that no objects are placed in the area around the seat belt catch as they could prevent it from being properly secured.
- Make sure the seat belt catch is properly positioned (it should not be hidden away, crushed or flattened by people or objects).

ADDITIONAL SAFETY DEVICES

2

Restraint devices in addition to front seat belts

Depending on the vehicle, they may comprise:

- **seat belt inertia reel pretensioners;**
- **chest force limiters;**
- **airbags driver and passenger front.**

These systems are designed to act independently or together when the vehicle is subjected to a frontal impact.

Depending on the severity of the impact, the system can cause:

- blocking of the seat belt;
- the seat belt inertia reel pretensioner which is triggered to correct seat belt slack;
- the airbag and force limiter.

Load limiter

Above a certain severity of impact, this mechanism is used to limit the force of the belt against the body so that it is at an acceptable level.

Pretensioners



The pretensioners hold the seat belt against the body, holding the occupant more securely against the seat, thus increasing the seat belt's efficiency.

In the event of a severe frontal impact and if the ignition is switched on, the system may engage the following depending on the force of the impact:

- the seat belt inertia reel pretensioner **1** which instantly retracts the seat belt.



– Have the entire restraint system checked following an accident.

– No operation whatsoever is permitted on any part of the system (airbag, electronic units, wiring) and the system components must not be reused on any other vehicle, even if identical.

– To avoid premature triggering of the system which may cause injury, only qualified Network personnel are authorised to work on the methods of restraint in addition to the front seat belt.

– The electrical trigger system may only be tested by a specially trained technician using special equipment.

– When the vehicle is scrapped, contact an approved dealer for disposal of the gas generators for the pretensioners and airbags.

ADDITIONAL SAFETY DEVICES

driver and passenger front Airbags

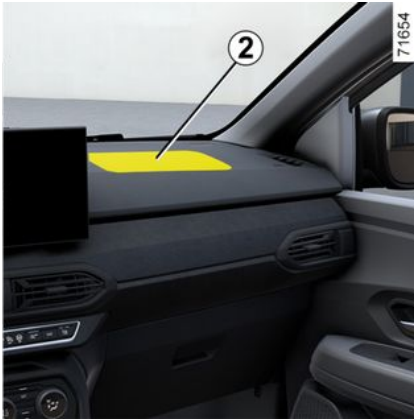

Fitted to the driver and passenger sides.

The presence of this equipment is indicated by the word "Airbag" on the steering wheel, dashboard (in the area of the airbag 2) and, depending on the vehicle, a label on the lower section of the windscreen.

Each airbag system consists of:

- an airbag and gas generator are fitted on the steering wheel for the driver and on the dashboard for the passenger;
- an electronic unit for monitoring the system controlling the gas generator electrical trigger;

- a single warning light  on the instrument panel;
- remote sensors (depending on the vehicle).



The airbag system uses pyrotechnic principles. This explains why, when the airbag inflates, it will generate heat, produce smoke (this does not mean that a fire is about to start) and make a banging noise. In a situation where an airbag is required, it will inflate immediately and this may cause some minor, superficial grazing to the skin or other problems.



Operation

This system is only operational when the ignition is switched on.

In the event of a severe **frontal** impact, the airbag(s) inflate rapidly, cushioning the impact of the driver's head and chest against the steering wheel and of the front passenger against the dashboard. They then deflate immediately so that the passengers are not in any way hindered when leaving the vehicle.

Operating faults



This warning light comes on when the engine is started and then

ADDITIONAL SAFETY DEVICES

goes out after approximately three seconds.

If it does not come on when the ignition is switched on or if it stays on, there is a fault in the system.

Contact your approved Dealer as soon as possible;

Your protection will be reduced until this fault is rectified.

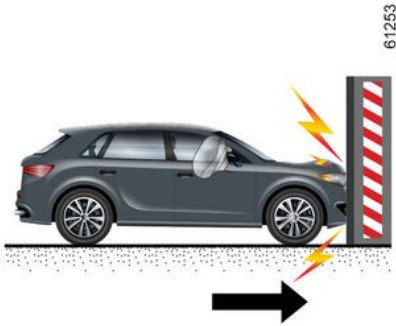

The following cases trigger the pretensioners or airbags.

In a frontal impact against a rigid (non-deformable) surface at an impact speed equal to or greater than **16 mph (25 km/h)**.

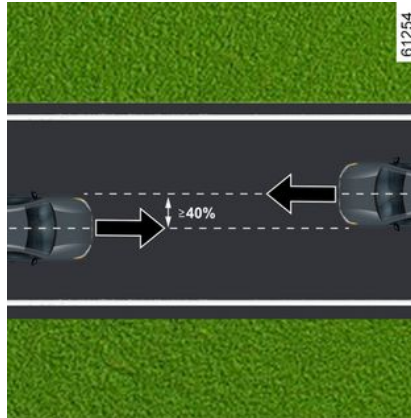

In a frontal impact with another vehicle of an equivalent or higher category, with an impact area equal to or greater than 40%, where the speed of both vehicles is equal to or greater than **25 mph (40 km/h)**.

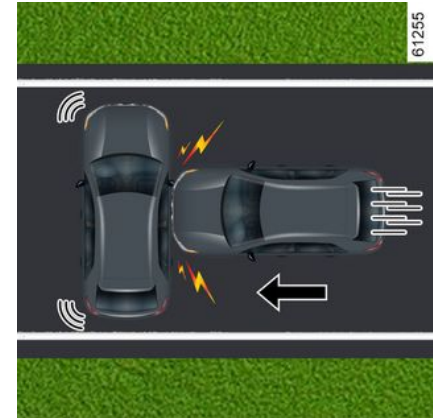

In a side impact with another vehicle of an equivalent or higher category, at an impact speed equal to or greater than **31 mph (50 km/h)**.

ADDITIONAL SAFETY DEVICES

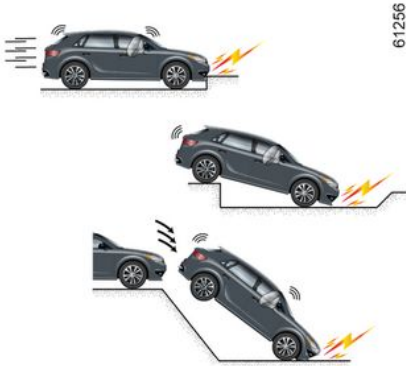

The pretensioners or airbags may be triggered by:

- an impact underneath the vehicle (e.g. pavement kerb);
- potholes;
- a drop or hard landing;
- stones;
- ...



The pretensioners or airbags may not be triggered by:

- a rear impact, however severe;
- the vehicle overturning;
- ...



- side impact at the front or rear of the vehicle;
- frontal impact, underneath the tail of a lorry;
- frontal impact against an obstacle with a sharp angle;
- ...

ADDITIONAL SAFETY DEVICES

Warnings

2

All of the following warnings are intended to ensure that the airbag is not obstructed in any way when it is inflated and also to prevent the risk of serious injury caused by items which may be projected when it inflates.



Warnings in relation to the driver's airbag

- Do not modify the steering wheel or the boss.
- Do not cover the steering wheel boss under any circumstances.
- Do not attach any objects (badge, logo, watch, telephone cradle, etc.) to the steering wheel boss.
- The steering wheel must not be removed (except by qualified personnel from our Network).
- Do not sit too close to the steering wheel: sit with your arms slightly bent (see "Adjusting your driving position" → 66). This will allow sufficient space for the airbag to deploy correctly and be fully effective.

Warnings in relation to the passenger airbag

- Do not attach or glue any objects (badge, logo, clock, telephone holder, etc.) to the dashboard on or near the airbag.
- Do not place anything between the dashboard and the passenger (animal, umbrella, walking stick, parcels, etc.).
- The passenger must not put his or her feet on the dashboard or seat as there is a risk that serious injuries may be sustained. As a general rule, parts of the body should be kept away from the dashboard (knees, hands, head, etc.).
- the devices in addition to the front passenger seat belt should be reactivated as soon as a child seat is removed, to ensure the protection of the passenger in the event of an impact.

A REAR-FACING CHILD SEAT MUST NOT BE FITTED TO THE FRONT PASSENGER SEAT UNLESS THE ADDITIONAL RESTRAINT SYSTEMS ARE NOT DEACTIVATED → 82.

ADDITIONAL SAFETY DEVICES

Methods of restraint in addition to the rear seat belts

Depending on the vehicle, they may comprise:

- **side seat belt inertia reel pretensioners;**
- **chest force limiters.**

These systems are designed to act independently or together when the vehicle is subjected to a frontal impact.

Depending on the severity of the impact, the system can cause:

- blocking of the seat belt;
- the seat belt inertia reel pretensioner (which engages to correct seat belt slack).

Load limiter

Above a certain severity of impact, this mechanism is used to limit the force of the belt against the body so that it is at an acceptable level.

Side seat belt pretensioners

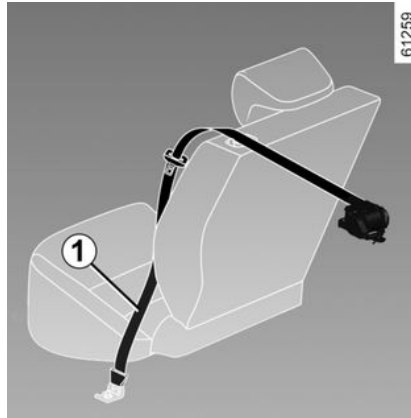

The pretensioners hold the seat belt against the body, holding the occupant more securely against the seat, thus increasing the seat belt's efficiency.

With the ignition on, following a significant frontal impact and depending on the severity of the impact, the system may trigger the seat belt inertia reel pretensioner **1** which instantly retracts the seat belt.



- Have the entire restraint system checked following an accident.
- No operation whatsoever is permitted on any part of the system (pretensioners, airbags, computers, wiring) and the system components must not be reused on any other vehicle, even if identical.
- Only qualified personnel from our Network may work on the airbags; otherwise the system may trigger accidentally and cause injury.
- The electrical trigger system may only be tested by a specially trained technician using special equipment.
- When the vehicle is scrapped, contact an approved dealer for disposal of the pretensioner and airbags gas generators.

Side protection devices

side Airbag

(depending on the vehicle)

ADDITIONAL SAFETY DEVICES

2 This airbag may be fitted to each of the front seats and is activated at the sides of the seats (door side) to protect the occupants in the event of a severe side impact.

curtain Airbag

This is an airbag fitted (depending on the vehicle) along the upper sides of the vehicle – they inflate along the front and rear door side windows to protect the passengers in the event of a severe side impact.

ADDITIONAL SAFETY DEVICES

Warnings



Warning in relation to the side airbag

- **Fitting seat covers:** seats equipped with an airbag require covers specifically designed for your vehicle. Contact an approved dealer to find out if these covers are available. The use of any covers other than those designed for your vehicle (including those designed for another vehicle) may affect the operation of the airbag and reduce your protection.
- Do not place any accessories, objects or even pets between the seatback, the door and the internal fittings. Do not cover the seatback with objects such as clothes or accessories. This may prevent the airbag from operating correctly or cause injury when the airbag is deployed.
- No work or modification whatsoever may be carried out on the seat or internal fittings, except by qualified personnel from our Network.
- The airbag is deployed through the slits in the front seatbacks (door side): never insert any objects in these slits.

ADDITIONAL SAFETY DEVICES

Additional restraint devices

2

All of the following warnings are provided to avoid obstructing the deployment of the airbag and to avoid serious injury caused by the projection of objects during its inflation.



The airbag is designed to complement the action of the seat belt. Both the airbag and the seat belt are integral parts of the same protection system. It is therefore essential to wear seat belts at all times. If seat belts are not worn, the occupants are exposed to the risk of serious injury in the event of an accident. It may also increase the risk of minor superficial injuries occurring when the airbag is deployed, although such minor injuries are always possible with airbags.

If the vehicle should overturn or suffer a rear impact, however severe, the pretensioners and airbags are not always triggered. Shocks to the underbody of the vehicle, from pavements, potholes, stones etc. can all trigger these systems.

- Work and modifications on the complete system (airbags, pretensioners, ECU, wiring harness, etc.), are **strictly prohibited** (except by qualified brand network personnel).
- To ensure that the system is in good working order and to avoid accidental triggering of the system which may cause injury, only qualified Network personnel may work on the airbag system.
- As a safety precaution, have the airbag system checked if your vehicle has been involved in an accident, or is stolen or broken into.
- When selling or lending the vehicle, inform the new purchaser of these conditions when handing over this vehicle user manual.
- When scrapping your vehicle, contact your approved dealer for disposal of the gas generator(s).

ADDITIONAL SAFETY DEVICES

Operating faults



The indicator light **1** lights up when the ignition is switched on and goes out after a few seconds.

If it does not light up when the ignition is switched on, or if it lights up when the engine is running, there is a fault with the system (airbags, pretensioners, etc.) for the front and/or rear seats.

Contact your Approved Dealer as soon as possible. Your protection will be reduced until this fault is rectified.

CHILD SAFETY

General information

2

Carrying children

Before purchasing a child seat, check that it complies with the regulations for the country you are in and that it can be fitted in your vehicle. Consult an approved Dealer to find out which seats are recommended for your vehicle.

Please ensure that you comply with the legislation of your country.

Children, and adults, must be correctly seated and strapped in for all journeys. The children being carried in your vehicle are your responsibility.

A child is not a miniature adult. Children are at risk of specific injuries as their muscles and bones have not yet finished growing. The seat belt alone would not provide suitable protection. Use an approved child seat and ensure you use it correctly.



To prevent the doors being opened, use the "Child lock" feature → 51.



Never leave a child unattended in the vehicle. Check that your child is always strapped in and that the belt or safety harness used is correctly set and adjusted. Avoid wearing bulky clothing which could cause the belts to slacken → 66. Never let your child put their head or arms out of the window. Check that the child is in the correct position for the entire journey, especially if asleep.



A collision at 31 mph (50 km/h) is the same as falling a distance of 10 metres. Transporting a child without a restraint is the equivalent of allowing him or her to play on a fourth-floor balcony without railings. Never travel with a child held in your arms. In the event of an accident, you will not be able to keep hold of the child, even if you yourself are wearing a seat belt. If your vehicle has been involved in a road accident, replace the child seat and have the seat belts and ISOFIX anchorage points checked.

Using a child seat

The level of protection offered by the child seat depends on its ability to restrain your child and on its installation. Incorrect installation compromises the protection it offers the child in the event of harsh braking or an impact.

Before purchasing a child seat, check that it complies with the regulations for the country you are in and that it can be fitted in your vehicle. Consult an ap-

CHILD SAFETY

proved Dealer to find out which seats are recommended for your vehicle.

The regulations on transporting children are specific to each country.

The use of a child seat during transport depends on the age and/or the size and/or weight of the child.

For children who do not need to be transported to a child seat, make sure that the seat belt is correctly adjusted and fastened.

In all cases, you must comply with the regulations of the particular country you are in.

Before fitting a child seat, read the manual and respect its instructions. If you experience any difficulties during installation, contact the manufacturer of the equipment. Keep the instructions with the seat.



Set a good example by always fastening your seat belt and teaching your child:

- to strap themselves in correctly;
- to always get in and out of the car at the kerb, away from busy traffic.

Do not use a second-hand child seat or one without an instruction manual.

Check that there are no objects in the vicinity of the child seat which could impede its operation.



Driver's responsibility when parking or stopping the vehicle

Never leave an animal, child or adult who is not self-sufficient alone in your vehicle, even for a short time.

They may pose a risk to themselves or to others by starting the engine, activating equipment such as the electric windows or by locking the doors.

Also, in hot and/or sunny weather, please remember that the temperature inside the passenger compartment increases very quickly.

RISK OF DEATH OR SERIOUS INJURY.

CHILD SAFETY

Choosing a child seat

2



Rear-facing child seats

A baby's head is, proportionally, heavier than that of an adult and its neck is very fragile. Transport the child in this position as long as possible (until the age of 2 at the very least). It supports both the head and the neck.

Choose a bucket type seat for best side protection and change it as soon as the child's head is higher than the shell.

Forward-facing child seats

Up to 18 kg or 4 years, the child may travel on a forward-facing seat.

Choose your seat according to the child's size: their head and abdomen are the areas which must be most protected. A forward-facing child seat which is firmly attached to the vehicle will reduce the risk of impact to the head. Ensure your child travels in a forward-facing seat with a harness for as long as their size permits.

Choose a bucket type seat for optimum side protection.w



Booster cushions

From 15 kg or 4 years, the child can travel using a booster seat, which will enable the seat belt to be adapted to suit his size and shape. The booster seat cushion must be fitted with guides to position the seat belt on the child's thighs rather than the stomach. It is recommended that you use a seatback which can be adjusted in terms of height to position the seat belt in the centre of the shoulder. It must never rest on the neck or on the arm.

Choose a bucket type seat for optimum side protection.w



CHILD SAFETY

Choosing a child seat mounting

There are two ways to attach child seats: using the seat belt or using the ISOFIX system.

Attachment via the seat belt

The seat belt must be adjusted in order to ensure it works in the event of sudden braking or impact.

Ensure that the strap paths indicated by the child seat manufacturer are observed.

Always check that the seat belt is correctly fastened by pulling it up, then pulling it out fully whilst pressing on the child seat.

Check that the seat is correctly held by moving it from side to side and back to front: the seat should remain firmly fixed.

Check that the child seat has not been installed at an angle and that it is not resting against a window.



Do not use the child seat if it risks unfastening the seat belt restraining it: the base of the seat must not rest on the buckle and/or catch of the seat belt.

Attachment using the ISOFIX system

Authorised child seats ISOFIX are approved in accordance with current regulations if any of the four cases below applies:

- Universal ISOFIX 3-point forward-facing seat;
- Semi-universal ISOFIX 2-point seat; vehicle-specific;
- i-Size which has either:
 - a strap which attaches to the third ring of the seat concerned;
 - or a strut that rests on the vehicle floor, compatible with the approved seat i-Size, the role of which is to prevent the child seat from moving in the event of a collision.



No modifications must be made to the component parts of the originally fitted restraint system (seat belts, ISOFIX, seats and their mountings).

In the latter three cases, check that your child seat can be installed by consulting the list of compatible vehicles.

Attach the child seat with the ISOFIX locks, if these are provided. The

ISOFIX system allows quick, easy and safe fitting.

The ISOFIX system consists of 2 rings and, in some cases, a third ring.



The seat belt must never be twisted or the tension relieved. Never pass the shoulder strap under the arm or behind the back. Check that the seat belt has not been damaged by sharp edges. If the seat belt does not operate normally, it will not protect the child. Consult an approved Dealer. Do not use this seat until the seat belt has been repaired.

CHILD SAFETY

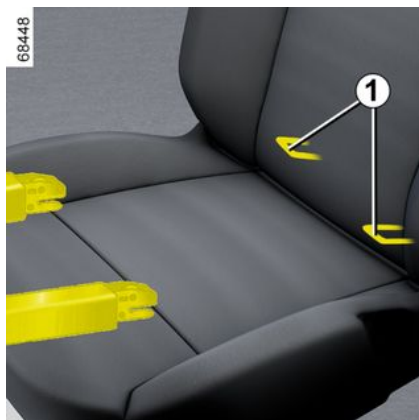

The two rings **1** are located between the seatback and the seat base and are identified by a  mark.



Before using an ISOFIX child seat that you purchased for another vehicle, check that its installation is authorised. Consult the list of vehicles which can be fitted with the seat with the equipment manufacturer.



When installing for the first time, use the seat belt buckle **2** to cut the fusible seams of the slots marked by the sym-

bol  to access the rings ISOFIX **1**.

Place the child seat opposite the slots and push on the base of the child seat base.

Check that the seat is locked to the rings correctly by moving it from left to right and then forwards and backwards.

Attachment using the ISOFIX system



The third ring **5** is used to attach the upper strap on some child seats. **3** on some child seats.

Rear seats

Attach the hook **4** to one of the rings **5** marked by the  symbol.



The anchoring points **5** must be used to attach the child seat's upper strap.

It is forbidden to use other mounting points to attach this strap.

CHILD SAFETY



The ISOFIX anchorage points have been exclusively designed for child seats with the ISOFIX system. Never fit a different type of child seat, seat belt or other objects to these fittings. Check that nothing is obstructing the anchorage points. If your vehicle has been involved in a road accident, have the ISOFIX anchorage points checked and replace your child seat.

CHILD SEATS

2

Fitting a child seat, general information

Some seats are not suitable for fitting child seats. The installation table and diagram indicate where to attach a child seat → 90.



Fit the child seat in a rear seat wherever possible.

Make sure the child seat or the child's feet do not prevent the front seat from locking correctly → 57.

Check that when installing the child seat in the vehicle it is not at risk of coming loose from its base.

If you have to remove the headrest, ensure that it is correctly stored so that it is not hurled around in the event of harsh braking or an impact.

Always attach the child seat to the vehicle even if it is not in use so that it does not come loose under harsh braking or impact.

The types of child seats indicated may not be available. Before using a differ-

ent child seat, check with the manufacturer that it can be fitted.

In the front seat

The laws concerning children travelling in the front passenger seat differ in every country. Consult the current legislation and follow the indications in the installation table and diagram → 90.

Before fitting a child seat in this seat (if authorised):

- lower the seat belt as far as possible;
- move the seat as far back as possible;
- gently tilt the seatback away from the vertical position (approximately 25°);
- on equipped vehicles, raise the seat base as far as possible.

Always fully raise the seat headrest so that it does not interfere with the child seat → 57.

After installing the child seat, when this is possible, you can move the vehicle seat forward if necessary (so as to leave enough space in the rear seats for passengers or other child seats). In the case of a rear-facing child seat, do not let it touch the dashboard or move it to the furthest forward position.

Do not change other settings after installing the child seat.



RISK OF DEATH OR SERIOUS INJURY: before fitting a rear-facing child seat in this seat, check that the airbag has been deactivated → 105.

In the rear side seat

A carrycot can be installed across the vehicle and will take up at least two seats. Position the child with his or her feet nearest the door.

Before installing a child seat in the ISOFIX anchoring points on a rear side seat, check that the seat belt buckles are not placed between the two ISOFIX anchorage points in this seat. If necessary, move the buckle from the seat in question towards the centre of the vehicle.

In order to install a rear-facing child seat, move the front seat as far forward as possible, then move the front seat back as far as it will go, without allowing it to come into contact with the child seat.

For the safety of a child in the facing forwards, move the seat as far back as possible and move the seat in front of the child forward, remembering to move the seatback forwards to avoid

CHILD SEATS

contact between the seat and the child's legs.

In all situations, remove the headrest of the rear seat on which the child seat is positioned → **88**. If necessary, position the rear seat as far back as possible. This must be done before fitting the child seat. Check that the child seat is resting against the seatback of the rear seat.



Installing a booster seat (group 2 or 3)

Check that the seat belt → **66** operates (winds)

correctly.

Adjust the seat belt by positioning:

- the shoulder strap on the child's shoulder without it touching their neck;
- the lap belt so that it lies flat on the thighs and against the pelvis.

If necessary, adjust the position of the vehicle seat.

In rear centre seat

A child seat may only be fitted in this seat if it is equipped with an inertia-reel seat belt. For any additional informa-

tion, please contact an authorised dealer.



A child seat with a floor support must never be installed on the rear centre seat. **RISK OF DEATH OR SERIOUS INJURY.**



Ensure that the child seat or the child's feet are not preventing the locking of the front seat at the front → **57** or → **59**.

CHILD SEATS

Attachment by seat belt

2 Fitting diagram, five-seater version

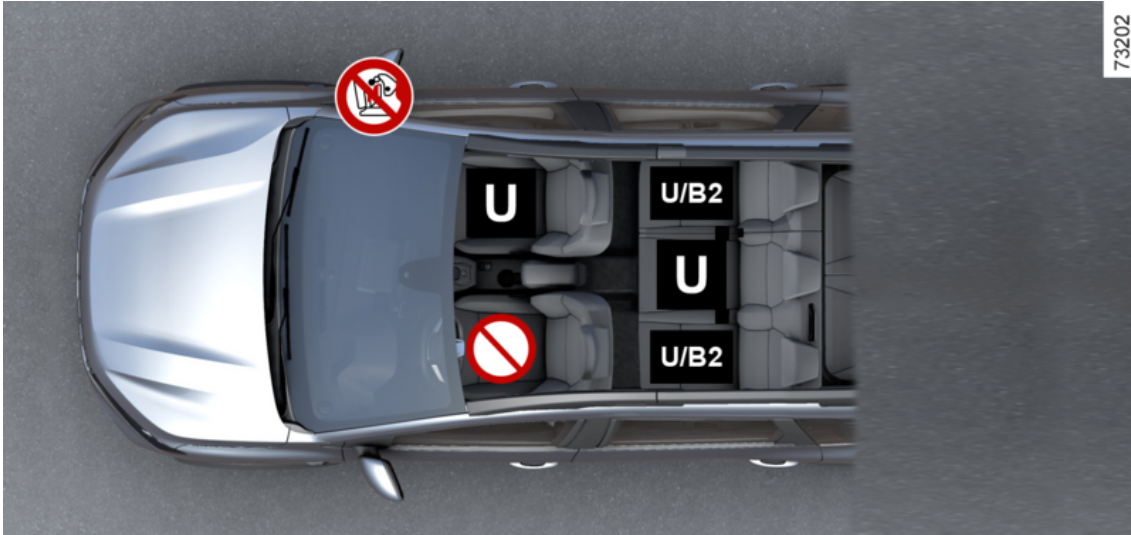

CHILD SEATS



Check the status of the airbag before fitting a child seat or allowing a passenger to use the seat.



Seat not suitable for fitting child seats.



Seat equipped for attaching a "Universal" approved seat using a seatbelt.

B2: seat enabling a child seat with "B2" approval to be attached by seat belt.



RISK OF DEATH OR SERIOUS INJURY: before fitting a rear facing child seat on the front passenger seat, check that the airbag has been deactivated → 105.



Check that your child is always strapped in and that the belt or safety harness used is correctly set and adjusted → 66.
If necessary, adjust the seat position accordingly.



Using a child safety system which is not approved for this vehicle will not properly protect the baby or child. They risk serious or even fatal injury.



It is prohibited to fit a child seat in the adjacent available seat when the large seatback is folded down onto the other seats → 59.

CHILD SEATS

Fitting diagram, seven-seater version

2

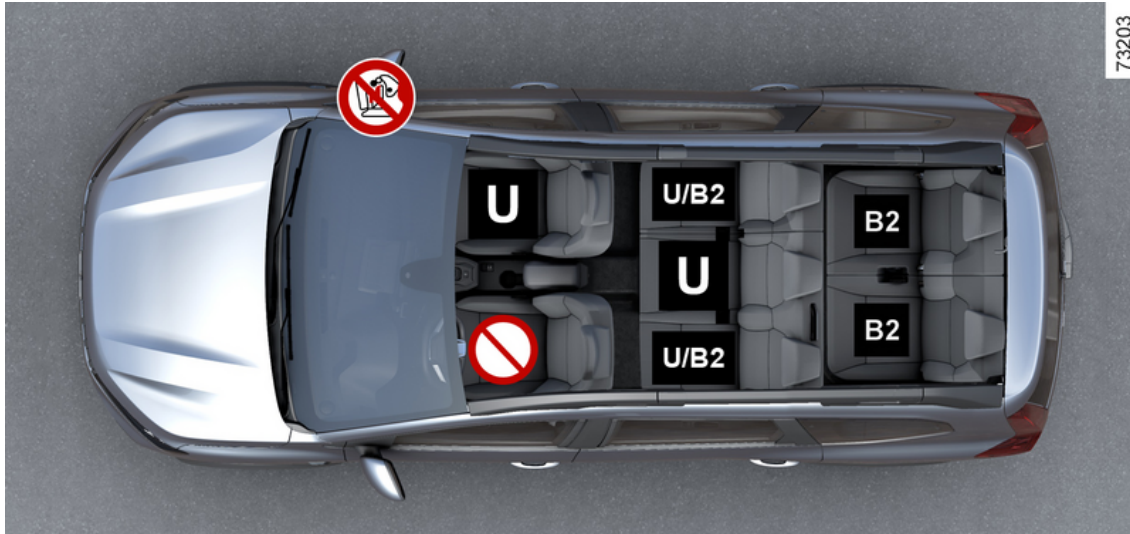

CHILD SEATS



Check the status of the airbag before fitting a child seat or allowing a passenger to use the seat.



Seat not suitable for fitting child seats.



Seat equipped for attaching a "Universal" approved seat using a seatbelt.

B2: seat enabling a child seat with "B2" approval to be attached by seat belt.



RISK OF DEATH OR SERIOUS INJURY: before fitting a rear facing child seat on the front passenger seat, check that the airbag has been deactivated → 105.



Check that your child is always strapped in and that the belt or safety harness used is correctly set and adjusted → 66.
If necessary, adjust the seat position accordingly.



Using a child safety system which is not approved for this vehicle will not properly protect the baby or child. They risk serious or even fatal injury.



It is prohibited to fit a child seat in the adjacent available seat when the large seatback is folded down onto the other seats → 59.

CHILD SEATS

Installation table

The table below summarises the information shown on the installation diagram in order to ensure the regulations in force are respected.

5-seat and 7-seat estate versions						
Type of child seat	Weight of the child	Front passenger seat		2nd row rear seats		3rd row rear seats
		with airbag without deactivation or with airbag activated (1)	without airbag or with airbag deactivated	Side seats	Centre seat	
Carrycot fitted across the vehicle Approved for group 0	< 10 kg	X	X	U (4)	X	X
Rear-facing shell seat Approved for group 0 or 0+	< 13 kg	X	U (2) (3)	U (5)	U (5) (7)	X
Rear-facing seat Approved for group 0+ or 1	< to 13 kg and 9 to 18 kg	X	U (2) (3)	U (5)	U (5) (7)	X
Forward-facing seat Approved for group 1	9 kg to 18 kg	U (3)	X	U (6)	U (6) (7)	X

CHILD SEATS

5-seat and 7-seat estate versions						
Type of child seat	Weight of the child	Front passenger seat		2nd row rear seats		3rd row rear seats
		with airbag without deactivation or with airbag activated (1)	without airbag or with airbag deactivated	Side seats	Centre seat	
Booster seat Approved for group 2 or 3	15 kg to 25 kg and 22 kg to 36 kg	U (3)	X	U / B2 (6)	U (6)	B2 (6)



(1) RISK OF DEATH OR SERIOUS INJURY: never install a rear-facing child seat on the front seat if the vehicle is equipped with a passenger airbag that cannot be deactivated.

(2) RISK OF DEATH OR SERIOUS INJURY: before fitting a rear-facing child seat in the front passenger seat, check that the airbag has been deactivated → 105.

Refer to the "Child safety equipment" booklet available from the network to choose the seat suited to your child and recommended for your vehicle.

X = Seat not suitable for fitting child seats.

U= Seat allowing a child seat with "Universal" approval to be attached by a seat belt: check that it can be fitted.

B2 = Booster seats in groups 2 and 3 (15 to 25 kg and 22 to 36 kg).

(3) Raise the seat to the maximum and position it as far back as possible, tilting the seatback slightly (approximately 25°).

(4) A carrycot can be installed across the vehicle and will take up at least two seats. Position the child with his or her feet nearest the door.

(5) In order to install a rear-facing child seat, move the front seat as far forward as possible, then move the front seat back as far as it will go without allowing it to come into contact with the child seat.

(6) Always retract the headrest of the rear seat on which the child seat is positioned. This action must be performed before fitting the child seat → 59. Move the seat in front of the child forwards, move the seatback forward to avoid contact between the seat and the child's legs.

CHILD SEATS



(7) **RISK OF DEATH OR SERIOUS INJURY:** a child seat with a floor support must never be fitted.

2

CHILD SEATS

Attachment using the ISOFIX system

2 Fitting diagram, five-seater version

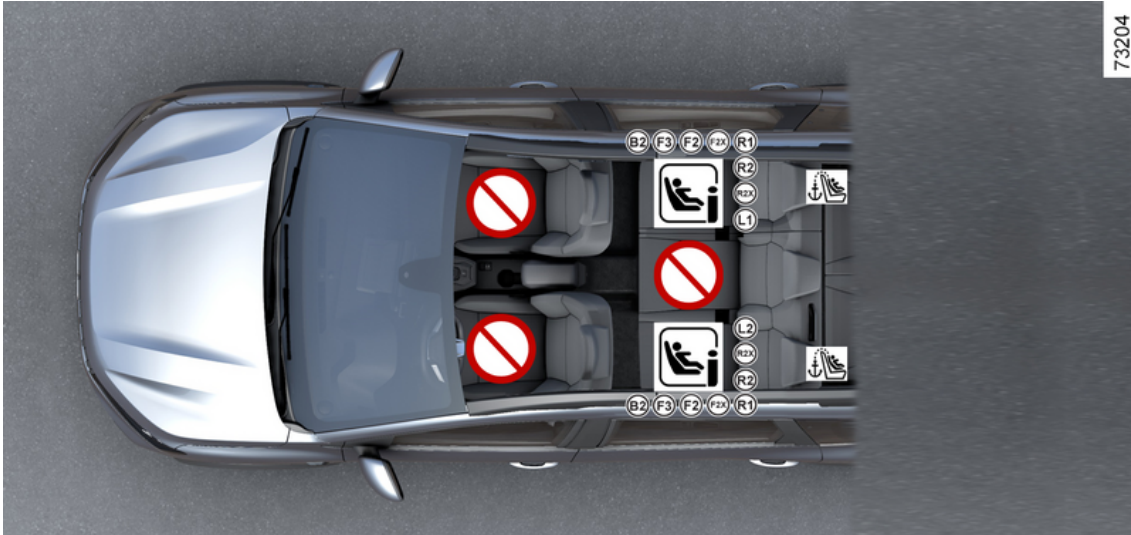

CHILD SEATS



Seat not suitable for fitting child seats.

Child seat attached using the ISOFIX system



Seat which allows an child seat to be fitted. ISOFIX



The rear side seats are equipped with an anchorage point allowing a forward-facing ISOFIX child seat with “Universal” approval to be attached. The anchorage points  are located on the rear parcel shelf, under a guard.



Check that your child is always strapped in and that the belt or safety harness used is correctly set and adjusted → 66.
If necessary, adjust the seat position accordingly.



Using a child safety system which is not approved for this vehicle will not properly protect the baby or child. They risk serious or even fatal injury.



It is prohibited to fit a child seat in the adjacent available seat when the large seatback is folded down onto the other seats → 59.

CHILD SEATS

Fitting diagram, seven-seater version

2

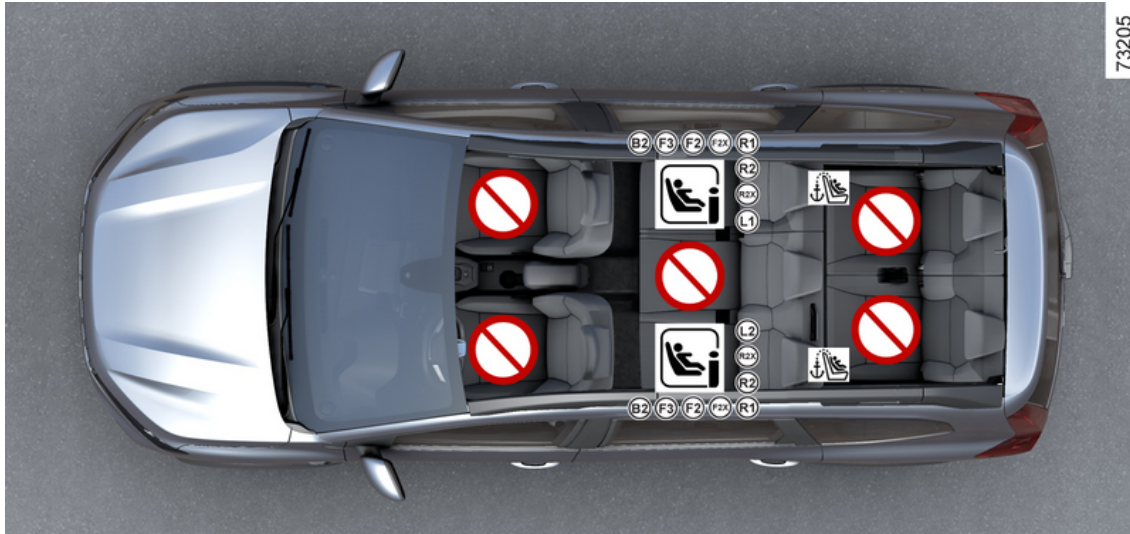

CHILD SEATS



Seat not suitable for fitting child seats.

Child seat attached using the ISOFIX system



Seat which allows an child seat to be fitted. ISOFIX



The rear side seats are equipped with an anchorage point allowing a forward-facing ISOFIX child seat with “Universal” approval to be attached. The anchorage points  are located on the rear parcel shelf, under a guard.



Check that your child is always strapped in and that the belt or safety harness used is correctly set and adjusted → 66.
If necessary, adjust the seat position accordingly.



Using a child safety system which is not approved for this vehicle will not properly protect the baby or child. They risk serious or even fatal injury.



It is prohibited to fit a child seat in the adjacent available seat when the large seatback is folded down onto the other seats → 59.

CHILD SEATS

Installation table

The table below summarises the information shown on the installation diagram in order to ensure the regulations in force are respected.

Four and five door versions						
Type of child seat	Weight of the child	Size of seat [fixture]	Front passenger seat		Rear seats	
			With airbag that cannot be deactivated	Without airbag or airbag deactivated	Side seats	Centre seat
Carrycot fitted across the vehicle Approved for group 0	< 10 kg	L1 [F], L2 [G]	X	X	X	X
Rear-facing shell seat Approved for group 0 or 0+	< 13 kg	R1 [E]	X	X	IL (1)	X
Rear-facing seat Approved for group 0+ or 1	< to 13 kg and 9 to 18 kg	R2 [D], R2X [D]	X	X	IL (1)	X
		R3 [C]	X	X	X	X
Forward-facing seat Approved for group 1	9 kg to 18 kg	F3 [A], F2 [B], F2X [B1]	X	X	IUF-IL (1) (2)	X
Booster seat Approved for group 2 or 3	15 kg to 25 kg	B2	X	X	IUF-IL (1) (2)	X
	22 kg to 36 kg	B3	X	X	X	X

CHILD SEATS

Four and five door versions						
Type of child seat	Weight of the child	Size of seat [fixture]	Front passenger seat		Rear seats	
			With airbag that cannot be deactivated	Without airbag or airbag deactivated	Side seats	Centre seat
Seat i-Size	Rear-facing seat		X	X	i-U (1)	X
	Forward-facing seat		X	X	i-UF (1) (2)	X
	Booster seat		X	X	i-UF (1) (2)	X

2

Refer to the "Child safety equipment" booklet available from the network to choose the seat suited to your child and recommended for your vehicle.

X = Seat not suitable for fitting child seats of this type.

IUF = Seat which allows forward facing child seats with "Universal" approval to be attached using ISOFIX attachments: check that it can be fitted.

IL = Seat which allows child seats with "Semi-universal" or "Vehicle specific" approval to be attached using ISOFIX attachments; check that it can be fitted correctly.

i-U = Suitable for "Universal" front-facing and rear-facing i-Size restraint systems: check that it can be fitted.

i-UF = Suitable only for "Universal" front-facing i-Size restraint systems.

(1) In order to install a rear-facing child seat, move the front seat as far forward as possible, then move the front seat back as far as it will go without allowing it to come into contact with the child seat.

(2) Always retract the headrest of the rear seat on which the child seat is positioned. This action must be performed before fitting the child seat → 59. Move the seat in front of the child forwards, move the seatback forward to avoid contact between the seat and the child's legs.

The size of the ISOFIX child seat is indicated by a letter:

- F3 [A], F2 [B], F2X[B1]: for forward-facing seats in Group 1 (9 to 18 kg);
- R2 [D], R2X [D], R3 [C]: rear-facing seats or shell seats in Group 0+ (less than 13 kg) or Group 1 (9 to 18 kg);
- R1 [E] rear-facing shell seats in Group 0 (less than 10 kg) or 0+ (less than 13 kg);
- L1 [F], L2 [G]: carrycots in group 0 (less than 10 kg);

CHILD SEATS

- B2 and B3: booster seats in groups 2 and 3 (15 to 25 kg and 22 to 36 kg).

2

CHILD SAFETY: DEACTIVATING, ACTIVATING THE FRONT PASSENGER AIRBAG

Warnings



The passenger airbag may only be deactivated or activated while the **vehicle is stationary with the ignition off.**

Front passenger airbag deactivation



Before installing a child seat on the front passenger seat:

- check that the child seat can be installed on this seat;

- you **must** deactivate the passenger airbag for a rear-facing child seat.



To deactivate the airbag : with the vehicle stationary and the ignition switched off, push and turn the lock 1 to the **OFF** position.

When the ignition is switched on, you

must check that the  warning light is illuminated on the display 2.

This warning light remains continuously lit to let you know that you can fit a child seat.



DANGER

Since operation of the front passenger airbag is not compatible with the position of a rear-facing child seat, **NEVER** fit a rear-facing child restraint system in a seat protected by a front **AIRBAG that is ACTIVATED.** This may lead to the **DEATH** of the **CHILD** or their **SERIOUS INJURY.**



CHILD SAFETY: DEACTIVATING, ACTIVATING THE FRONT PASSENGER AIRBAG

2



The markings on the dashboard and the labels **A** on each side of the passenger sun visor **3** (see example of label above) are provided to remind you of these instructions.

Front passenger airbag activation





You should reactivate the airbag as soon as you remove the child seat from the front passenger seat to ensure the protection of the front passenger in the event of an impact.



To reactivate the airbag : with the vehicle stationary and the ignition off, push and turn the lock **1 to **ON** position.**

When the ignition is switched on, you

must check that the  warning



light is off and that the  warning light appears on the display **2** during approximately one minute each time the engine is started.

The front passenger airbag is activated.

Operating faults

In the event of a fault with the front passenger airbag activation/deactiva-

CHILD SAFETY: DEACTIVATING, ACTIVATING THE FRONT PASSENGER AIRBAG

tion system, the  and  warning lights are displayed on the instrument panel. Switch off the ignition and check the position of the lock **1**.

Switch the ignition back on: the warning lights go out.

If the problem persists, it signals a system failure. In this case, it is prohibited for a rear-facing child seat to be fitted to the front passenger seat or for any other passenger to occupy the seat.

Contact your approved Dealer as soon as possible;

DRIVING POSITION

Driver's position: left-hand drive

2

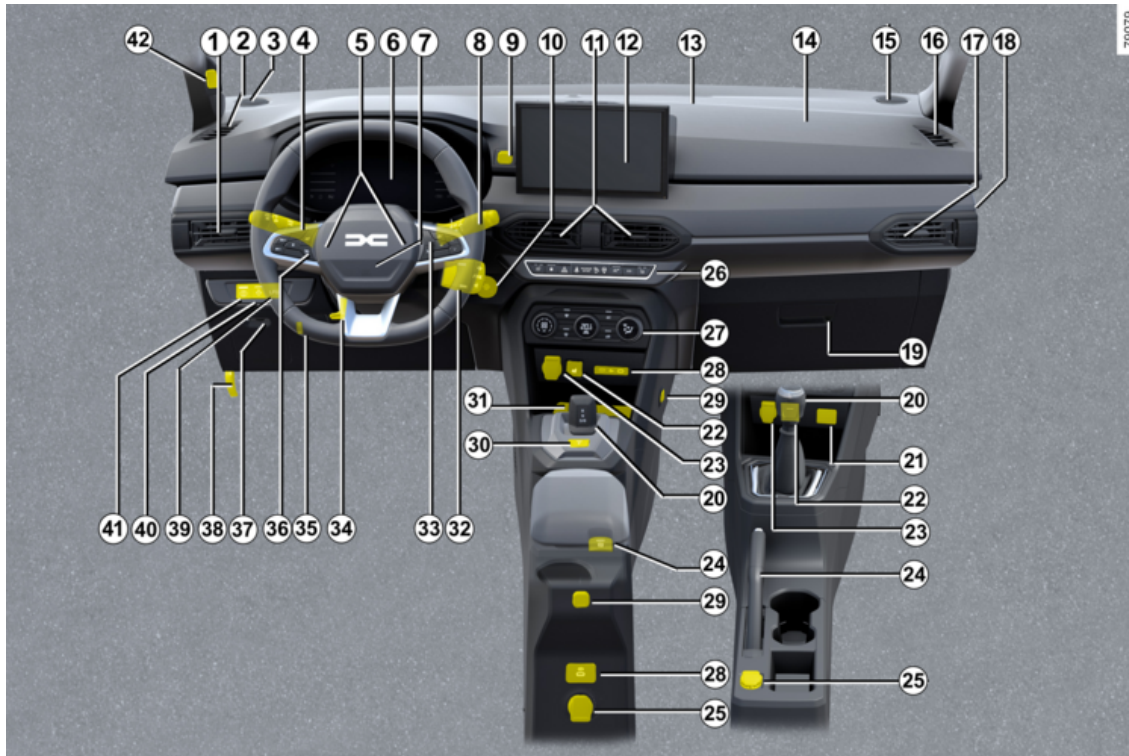

DRIVING POSITION

The equipment described **DEPENDS ON THE VEHICLE VERSION AND COUNTRY.**

1. Side air vent.
2. Side demister outlet.
3. Tweeter.
4. Stalk for:
 - direction indicator lights;
 - exterior lights;
 - front fog lights;
 - rear fog lights.
5. Horn.
6. Instrument panel.
7. Driver airbag location.
8. Windscreen and rear screen wiper/washer stalk.
9. Multimedia socket.
10. Ignition switch or start button (depending on the vehicle).
11. Centre air vents.
12. Navigation system or storage compartment (depending on the vehicle).
13. Central demister outlet.
14. Passenger airbag location.
15. Tweeter.
16. Side demister outlet.
17. Side air vent.
18. Passenger airbag activation or deactivation switch.
19. Glovebox
20. Gear lever.
21. Multimedia socket.
22. the traction control activation/deactivation control - Extended grip (depending on the vehicle).
23. Cigarette lighter or accessories socket.
24. Handbrake or activation/deactivation control for the electronic parking brake (depending on the vehicle).
25. Accessories socket.
26. Main switch for:
 - depending on the vehicle, the driver and front passenger heated seats;
 - activation/deactivation of central door locking;
 - activation/deactivation of the hazard warning lights;
 - activation/deactivation of the Stop and Start function or Park Assist (depending on the vehicle);
 - activation/deactivation of ECO mode (depending on the vehicle);
 - the E-Save activation/deactivation button (depending on the vehicle).
27. Heating or air conditioning controls.
28. Sockets USB-C.
29. YouClip multi-accessory holder.
30. Parking button.
31. Charging zone/telephone storage
32. Radio remote control.
33. Control:
 - trip computer information readout;
 - multimedia system voice control.
34. Control for adjusting steering wheel height and reach.
35. Beam height adjustment control.
36. Function settings controls:
 - speed limiter;
 - cruise control.
37. Fuse box.
38. Bonnet release control.
39. LPG control
40. Heated steering wheel or, depending on the vehicle, general Park Assist on/off switch.
41. My Safety button. → 213
42. Interior camera → 240

DRIVING POSITION

Driver's position, right-hand drive

2

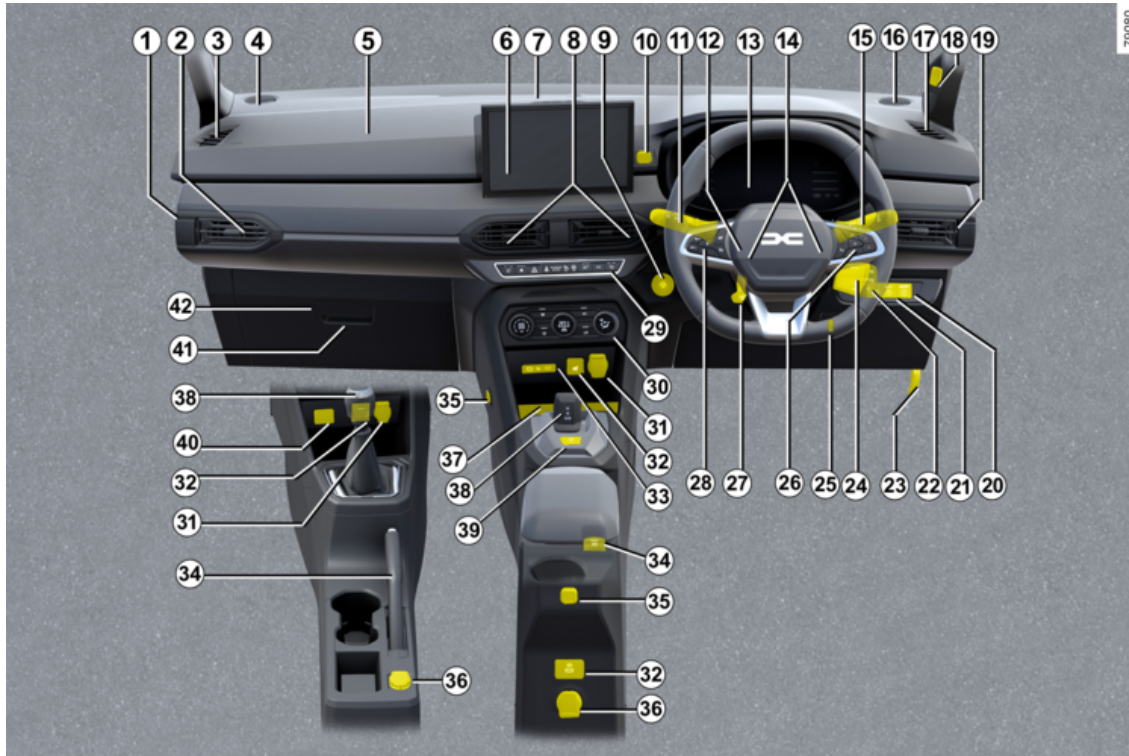

DRIVING POSITION

The presence of the equipment DEPENDS ON THE VEHICLE VERSION AND COUNTRY.

1. Passenger airbag activation or deactivation switch.
2. Side air vent.
3. Side demister outlet.
4. Tweeter.
5. Passenger airbag location.
6. Navigation system or storage compartment (depending on the vehicle).
7. Central demister outlet.
8. Centre air vents.
9. Start button or ignition switch (depending on the vehicle).
10. Multimedia socket.
11. Stalk for:
 - direction indicator lights;
 - exterior lights;
 - front fog lights;
 - rear fog lights.
12. Driver airbag location.
13. Instrument panel.
14. Horn.
15. Windscreen and rear screen wiper/washer stalk.
16. Tweeter.
17. Side demister outlet.

18. Interior camera → 240
19. Side air vent.
20. My Safety button.
21. Heated steering wheel or, depending on the vehicle, general Park Assist on/off switch.
22. LPG control
23. Bonnet release control.
24. Radio remote control.
25. Beam height adjustment control.
26. Control:
 - trip computer information readout;
 - multimedia system voice control.
27. Control for adjusting steering wheel height and reach.
28. Function settings controls:
 - speed limiter;
 - cruise control.
29. Main switch for:
 - depending on the vehicle, the driver and front passenger heated seats;
 - activation/deactivation of central door locking;
 - activation/deactivation of the hazard warning lights;
 - activation/deactivation of the Stop and Start function or Park Assist (depending on the vehicle);
 - activation/deactivation of ECO mode (depending on the vehicle);

- the E-Save activation/deactivation button (depending on the vehicle).
30. Heating or air conditioning controls.
 31. Cigarette lighter or accessories socket.
 32. the traction control activation/deactivation control - Extended grip (depending on the vehicle).
 33. Sockets USB-C.
 34. Handbrake or activation/deactivation control for the electronic parking brake (depending on the vehicle).
 35. YouClip multi-accessory holder.
 36. Accessories socket.
 37. Charging zone/telephone storage
 38. Gear lever.
 39. Parking button.
 40. Multimedia socket.
 41. Glovebox
 42. Fuse box.

TRIP COMPUTER

General information

2 Trip computer A or B

Depending on the vehicle, this includes the following functions:

- mileage;
- trip settings;
- information messages;
- operating fault messages (related to

the  warning light);

– warning messages (related to the

STOP warning light);

– vehicle settings customisation menu

→ 128.

Vehicle fitted with trip computer A



– **With the vehicle stationary**, press the switch **1** as many times as re-

quired to reach the  tab;

– press switch **4 "OK"**;

Select the function by repeatedly pressing switch **2** or **3** and press the switch **4 "OK"** to confirm.

f) Trip log, operating fault and information message readout;

b) Trip settings:

- average fuel consumption;
- current fuel consumption;
- estimated mileage with remaining fuel;

- mileage;
- average speed;
- average LPG consumption;
- estimated range with remaining LPG fuel;
- LPG distance;

c) total mileage and trip mileage recorder and average speed;

d) reset the tyre pressures;

e) set the time;

f) mileage before service:

- distance before service;
- distance before oil change.

g) estimated range with remaining re-agent.

TRIP COMPUTER

Vehicle fitted with trip computer **B**



Depending on the vehicle, it allows the following functions to be displayed in zone **5**. Select the functions by repeatedly pressing switch **2** or **3**:

- mileage;
- trip settings;
- information messages;
- operating fault messages (related to

the  warning light);

- warning messages (related to the

 warning light);

- ECO monitor;

- depending on the vehicle, energy flow;
- vehicle inclinations and compass;
- guidance information.

Zone **6** can be customised using switch **1** and displays the following functions;

- rev counter or, depending on the vehicle, charge meter;
- driving aids.

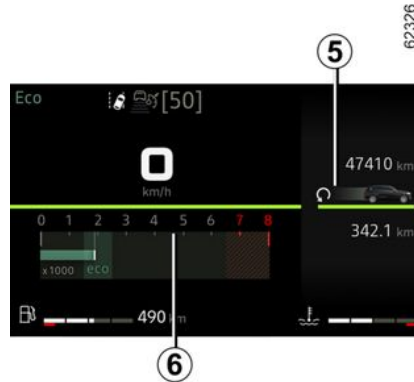

Selections for display in zone **5**

(the display depends on the vehicle equipment and country):

- f) Trip log, operating fault and information message readout;
- b) Trip settings:
 - average fuel consumption;

- current fuel consumption;
- estimated mileage with remaining fuel;
- mileage;
- average speed;
- average LPG consumption;
- estimated range with remaining LPG fuel;
- LPG distance;

c) trip mileage recorder and average speed;

d) reset the tyre pressures;

e) distance before service:

- distance before service;
- distance before oil change.

f) estimated range with remaining agent;

g) ECO monitor;

h) depending on the vehicle, energy flow;

i) vehicle inclinations and compass;

j) guidance information;

k) coolant temperature indicator (Hybrid vehicle).

Resetting the trip mileage recorder and journey parameters (reset button)

With one of the trip settings selected as the display, press and hold switch **2** or **3** until the display resets to zero.

TRIP COMPUTER

Interpreting some of the values displayed after resetting

2

The values showing average fuel consumption, range and average speed will become more stable and reliable the further you travel after pressing the reset button.

For the first few miles after pressing the reset key you will notice that the range increases as you travel.

This range takes into account the average fuel consumption since the last time the reset button was pressed.

However, average consumption can decrease when:

- the vehicle stops accelerating;
- the engine reaches its operating temperature (if the engine was cold when the reset key was pressed);
- when driving from an urban area onto the open road.

Automatic resetting of the journey parameters





Resetting occurs automatically when the maximum value of any of the parameters is exceeded.

TRIP COMPUTER

Journey settings





The display of information shown below **DEPENDS ON THE VEHICLE EQUIPMENT AND COUNTRY.**

2

Examples of selections	Interpreting the display selected
Vehicle Systems OK	a) Trip log. Successive display: <ul style="list-style-type: none">– information messages (passenger airbag OFF, etc.);– operating fault messages ("Check injection", etc.).
Current  7.4 L/100	b) Journey parameters Current fuel consumption. This value is displayed after a speed of approximately 19 mph (30 km/h) is reached.
Average  5.8 L/100	Average fuel consumption since the last reset. The value is displayed after having travelled at least 400 metres since the last reset.
Range  112.4 km	Estimated range with remaining fuel. The value is displayed after driving 400 metres.
Distance  112.4 km	Distance travelled since last reset.
Average  123.4 km/h	Average speed since last reset. The value is displayed after driving 400 metres.
Average LPG	Average LPG fuel consumption.

TRIP COMPUTER

2

Examples of selections	Interpreting the display selected
 5.8 L/100	
Range LPG  112.4 km	Estimated range with remaining LPG fuel.
Distance LPG  112.4 km	Distance travelled using LPG since the last Reset.
Distance  112.4 km	c) Trip mileage recorder Distance travelled. since last reset.
Average  123.4 km/h	Average speed since last reset. The value is displayed after driving 400 metres.
Tyre pressure init. long press	d) Reset the tyre pressures. → 202
16:30	e) Set the time. → 131

TRIP COMPUTER

Examples of selections	Interpreting the display selected
 <p>The image shows two fuel gauges. The top gauge features a dark square icon with a white fuel pump symbol and the letters 'LPG' below it. The bottom gauge features a white fuel pump symbol on a dark background. Both gauges have a horizontal scale with 10 segments, marked '0' at the left and '1' at the right.</p>	Petrol mode.

TRIP COMPUTER

Examples of selections

Interpreting the display selected

2

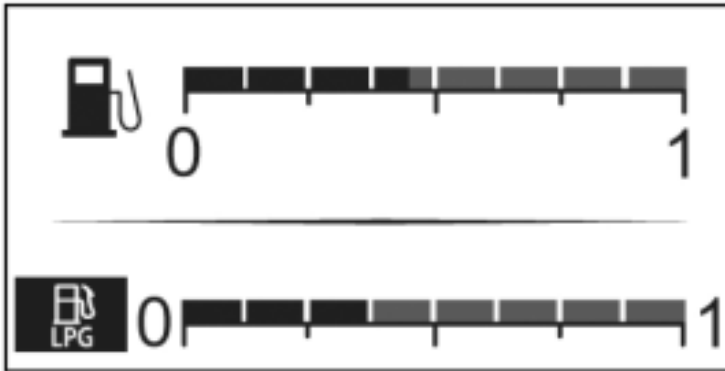

LPG mode.

TRIP COMPUTER

2

Examples of selections On-board computer with distance-before-service message	Interpreting the display selected
Service in 30 000 Km / 12 months	<p>f) Mileage before service. With the ignition on and the engine not running, access the distance before service information. When the distance or time value approaches its limit, there are several possible scenarios:</p>
Service due in 300 Km / 24 days	<p>– distance remaining less than 932 miles (1,500 km) or one month: the "Service due in" message is displayed accompanied by the nearest limit (distance or time); – if the range is 0 miles (0 km) or if the service date is reached: the "Service required" message is displayed accom-</p>
Service required	<p>panied by the  warning light. The vehicle requires a service as soon as possible.</p>
<p>Reset: to reset the range before the next service, press and hold for approximately 10 seconds on the "OK" button until the range before service is displayed continuously.</p> <p>Note: if a service is performed without changing the engine oil, only the distance before the next service should be reset. In the event of an oil change, both the distance before the next service and the next oil change should be reset.</p>	

TRIP COMPUTER

2

Examples of selections	Interpreting the display selected
On-board computer with distance-before-service message	
Oil change in 30 000 km/24 months	Distance before oil change With the ignition on and the engine not running , access the mileage information to display the distance before the next oil change.
<p>Depending on the vehicle, the mileage before an oil change varies according to the driving style (frequent driving at low speed, door-to-door journeys, extensive use at idling speed, towing a trailer, etc.). The distance remaining until the next oil change can therefore decrease more quickly in some cases than the actual distance travelled.</p> <p>Reset: to reset the range before the next service, press and hold for approximately 10 seconds on the "OK" button until the range before oil change is displayed continuously.</p> <p>Note: if a service is performed without changing the engine oil, only the distance before the next service should be reset. In the event of an oil change, both the distance before the next service and the next oil change should be reset.</p>	
Top Up AdBlue before 2400 km	g) estimated range with remaining reagent → 157.

TRIP COMPUTER

Information messages

These can help in the vehicle starting phase, or give information about a selection or a driving status.

Examples of information messages are given in the following pages.

Examples of messages	Interpreting the display selected
« Parking Brake ON »	Indicates that the parking brake has been applied.
« Vehicle Checks in Progress »	Displayed with the ignition on when the vehicle is running self-diagnostics.
« Turn Steering Wheel + START »	Turn the steering wheel slightly whilst pressing the vehicle start button to unlock the steering column.
« WARNING: Power Steering »	Indicates that the steering column has not been locked.

TRIP COMPUTER

Operating fault messages

2

These appear with the  warning light and mean that you should drive very carefully to an approved dealer as soon as possible. If you fail to follow this recommendation, you risk damaging your vehicle.

They disappear when the display selection key is pressed or after several seconds and are stored in the computer log. The



warning light stays on. Examples of operating fault messages are given in the following pages.

Examples of messages	Interpreting the display selected
« Clean Diesel Filter »	Indicates the presence of water in the diesel filter; contact an approved Dealer as soon as possible.
« Check vehicle »	Indicates a fault in one of the pedal sensors, battery management system or oil level sensor.
« WARNING: Check Airbag »	Indicates a fault in the restraint system in addition to the seat belts. In the event of an accident, it is possible that they may not be triggered
« Check Anti- Pollution System »	– Indicates a fault in the vehicle's particle filter system. – Indicates a fault in the emissions reduction system when it is accompanied by the  → 157 warning light.
« Check SOS Call »	Indicates a fault in the emergency call system.
« Check Electric System »	Indicates a fault in the traction system.

TRIP COMPUTER

Warning messages

These appear with the **STOP** warning light and require you to stop immediately, for your own safety, as soon as traffic conditions allow. Stop your engine and do not restart it. Call an approved Dealer.

Some examples of warning messages are given below. **Note:** the messages appear on the display either individually or alternately (when there are several messages to be displayed), and may be accompanied by a warning light and/or a beep.

Examples of messages	Interpreting the display selected
« WARNING: Engine Failure Risk »	Indicates an injection fault, the vehicle's engine has overheated or there is a serious engine fault.
« WARNING: Power Steering »	Indicates a fault in the steering system.
« WARNING: Braking System »	Indicates a fault in the braking system. Apply the electronic parking brake manually and ensure that the vehicle is immobilised using a chock.
« Electric System Failure »	Indicates a problem in the vehicle battery charging circuit (alternator, etc.) or a fault with the electric traction system.
« WARNING: Gearbox Failure Risk »	Indicates an automatic gearbox fault.
« Electric motor failure »	Indicates that the vehicle is losing power.
« Puncture »	Indicates that at least one wheel is punctured or severely underinflated.

TRIP COMPUTER

Displays and indicators

2 The presence and operation of the display and indicators **DEPENDS ON THE LEVEL OF EQUIPMENT AND THE COUNTRY.**

Instrument panel **A**



lights up when the driver's door is opened. In some cases, the appearance of a warning light is accompanied by a message.



Rev counter **1** (rpm x 1000)



Speedometers **2** and, depending on the vehicle, **3**

(km or miles per hour)

Control your speed according to the speedometer **2** or **3**. In case of a difference between the speedometers, refer to the approved speedometer **2** and consult an approved Dealer.

4 Fuel gauge

The number of squares lit shows the fuel level. When it is at minimum, the squares disappear and the low fuel level warning light comes on, depending on the vehicle.

Instrument panel **B**



lights up when the driver's door is opened. In some cases, the appearance of a warning light is accompanied by a message.

TRIP COMPUTER

Selection of views

Depending on the vehicle, several views may be available on the instrument panel. To select a view, press control **5** as many times as necessary to scroll through the different views on the instrument panel **B** until you reach the desired view.

All of the available views display the following essential information on the instrument panel:

- speedometer;
- the information on the activated driving aids;
- information area.

The "Minimal" view displays only the essential information on the instrument panel.

The "Classic" view displays essential information, the rev counter and the power meter (depending on the vehicle) on the instrument panel.

The "Driving Aids" view displays detailed and instantaneous information related to the activated driving aids on the instrument panel. For example, the proximity of a white line or being too close to the vehicle in front.

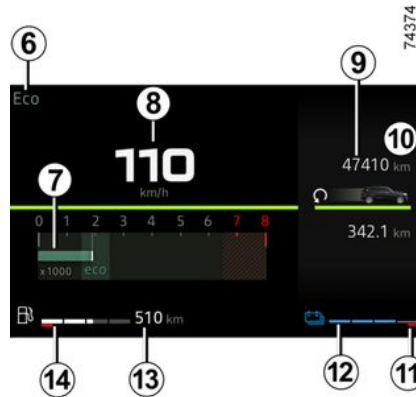

Information display

Excessive speed audible alarm

Depending on the vehicle and country,

the  warning light is displayed and a beep sounds. This beep sounds as soon as the vehicle is travelling at over 75 mph (120 km/h). This warning light remains lit for as long as the vehicle is travelling at over 75 mph (120 km/h).

Driving mode selected **6** → 192

Rev counter **7**

(scale x 1,000)

This is displayed differently according to how the instrument panel is custom-

ised. Depending on the style selected, it may not be displayed.

Speedometer **8**

Depending on the style selected, the display varies.

Total mileage recorder **9** → 115

Coolant temperature indicator **12**

In normal use, the indicator **12** should be located before zone **11**.

Under "intensive" operating conditions, the needle may approach this zone.

This is not serious unless the warning

light  comes on accompanied by a message on the instrument panel and a beep.

Estimated range with remaining fuel **13**

The value is displayed after driving 400 metres → 115.

Fuel gauge **14**

If the level is at the minimum, warning

light  integrated in the indicator comes on orange, accompanied by a beep.

Fill the tank with at least 1.76 gal (8 litres) of fuel.

Information area **10** → 112

TRIP COMPUTER

2



Depending on the vehicle, use control **15** or **16** to browse and select the various widgets on the instrument panel:

- trip computer information (mileage recorder, warning messages, etc.);
- multimedia information (compass, audio source currently playing, etc.);
- ...

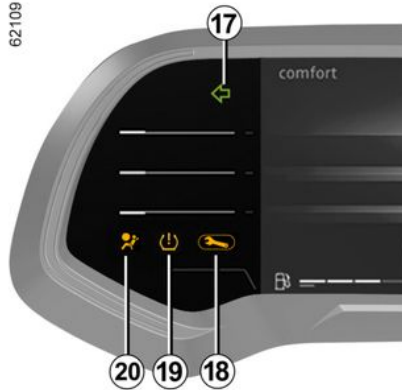

Direction change indicators 17

Warning light 18 → 132

Tyre low pressure warning light 19 → 202

airbag warning light 20 → 208

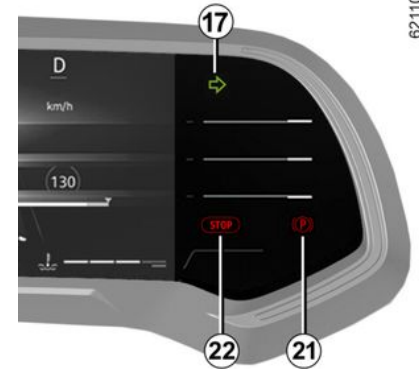

Parking brake or Electronic parking brake warning light 21 → 180

Urgent stop warning light 22 → 132

Hybrid version

lights up when the driver's door is opened. In some cases, the appearance of a warning light is accompanied by a message.

TRIP COMPUTER

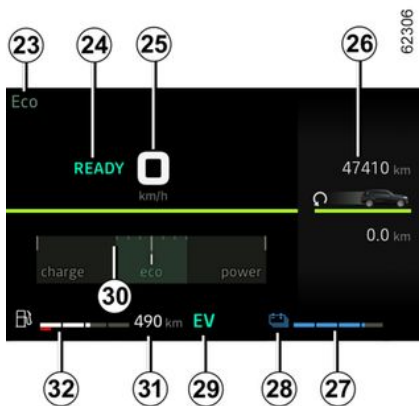

Driving mode selected 23

Message indicating that the vehicle is ready to drive 24

The READY message appears when the ignition is switched on and disappears when the vehicle speed exceeds approximately 3 mph (5 km/h).

Speedometer 25

Depending on the style selected, the display varies.

"High voltage" traction battery level remaining 27

Traction battery level low

In the event of extreme use at low speed, the traction battery charge may reach a low level.

The warning light **28** is displayed in yellow to warn you.

The electric motor performance will be limited to ensure that the Hybrid system operates correctly, until the battery charge level becomes sufficient.

Opt for a smoother driving style or, if possible, stop the vehicle without switching off the ignition until the warning light **28** appears in blue once again.

Immobilisation threshold imminent

In the event of extreme and prolonged use of the vehicle (e.g. towing or driving in steep off-road conditions) at speeds below 6 mph (10 km/h), the charge level may reach the threshold for imminent immobilisation.

A beep sounds and the warning light



appears in red.

If the charge level continues to drop, the electric range value will no longer be displayed.

If possible, stop the vehicle when traffic conditions allow it.

Leave the combustion engine on until the warning lights disappear.

This must be done to recharge the traction battery.

Electric operating mode warning light 25

It is displayed when only the traction battery is powering movement of the vehicle.

Energy flow indicator 29 → 24

Charge meter 30 → 192

Estimated range with remaining fuel 31

The value is displayed after driving 400 metres → 115.

Fuel gauge 32

If the level is at the minimum, warning

light  integrated in the indicator comes on orange, accompanied by a beep.

Whatever the remaining battery level, fill the tank with at least 1.76 gal (8 litres) of fuel.

If the vehicle runs completely out of fuel, fill the tank with at least 1.76 gal (8 litres) of fuel.

Otherwise, Hybrid mode will remain unavailable.

Information area 26 → 112

TRIP COMPUTER

2



Depending on the vehicle, use control **15** or **16** to browse and select the various widgets on the instrument panel:

- trip computer information (mileage recorder, warning messages, etc.);
- multimedia information (compass, audio source currently playing, etc.);
- energy flow indicator;
- coolant temperature indicator;
- ...

Engine oil level low warning

When the engine is started, the instrument panel display alerts you when the minimum oil level is reached → **320**.

The first time the warning appears, it can be cleared by pressing the "**OK**" switch.

Subsequent warnings will disappear automatically after around 30 seconds.

Instrument panel in miles

(option to switch to km/h)

Vehicles not fitted with a multimedia screen



- With the ignition off, press the switch **5** as many times as required to reach the "Settings" world;
- press **15** or **16** repeatedly to access "Vehicle setting", then press **33** "**OK**";
- press **15** or **16** repeatedly to access "DASHBOARD", then press **33** "**OK**";

– press **15** or **16** repeatedly to access "Unit: km/h" (or "Unit: mph" if required), then press **33** "**OK**";

Vehicles fitted with a multimedia screen.

Please refer to the multimedia instructions to select the unit.

Note: in both cases, once the battery is switched off, the on-board computer automatically returns to the original unit of measurement.

To return to the previous mode, repeat the same operation.

Please refer to the multimedia instructions for further information.

Vehicle settings personalisation menu

Depending on the vehicle equipment, this function allows you to activate/deactivate and adjust some of the vehicle's functions.

TRIP COMPUTER

Vehicles fitted with a multimedia screen 1



Accessing the settings menu

Refer to the various multimedia instructions for information on accessing the settings.

Adjusting the settings

Select a menu then the function to be modified (the display depends on the vehicle equipment and country):

a) "DRIVING ASSIST":

- Indicator volume.

b) "ACCESS":

- Release driver's door;
- Lock doors during driving;
- Opening/closing in hands-free mode;
- Remote locking/approach unlocking;

- Remote locking sound;
- Silent mode;
- Automatic locking;

c) "WIPING and LIGHTING":

- Follow-me-home lighting;
- Wiping in reverse;
- Automatic front wiping;
- Wipe after wash;

d) "Welcome":

- Exterior welcome;
- Automatic deployment of door mirrors;
- Interior welcome;
- Courtesy light auto mode

Depending on the function, select:

- "ON" or "OFF" to activate or deactivate it,

or

- a setting for the time the lights are switched on (e.g. for the "Follow-me-home lighting" function).

Please refer to the multimedia instructions for further information.



For safety reasons, carry out any adjustments while the vehicle is stationary.

Vehicles not fitted with a multimedia screen



Accessing the settings menu on display 2

(depending on the vehicle)

- **With the vehicle stationary**, press the switch **3** as many times as re-

quired to reach the  tab;

or

- depending on the vehicle, press switch **3** and repeatedly press control

4 or **5** to reach the  tab;

- press switch **6** "OK";

TRIP COMPUTER

– repeatedly press control **4** or **5** to

reach the  menu, then press switch **6 "OK"**.

Adjusting the settings

Navigate using control **4** or **5** to select the function to be modified and press switch **6 "OK"** to confirm (display may vary according to vehicle equipment and country):

a) "DASHBOARD":

- Language;
- Unit;

b) "VEHICLE":

- Rear windscreen wiping in reverse gear;
- Automatic windscreen wiping;
- Front-rear drip wiping function;
- Exterior welcome;

c) "PARKING ASSIST":

- Beep volume;

d) "DRIVING ASSIST":

- Lane departure warning sound volume;
- Lane departure warning sensitivity;
- Lane departure warning vibration;
- Lane Keep Assist sensitivity;
- Blind spot;
- Active braking;
- Speed warning;
- Distance warning;
- ...

e) "LIGHTING":

- Courtesy light auto mode;
- Automatic follow-me-home lighting;
- Follow-me-home lighting: XX seconds.

f) "ACCESS":

- Lock doors during driving;
- Opening/Closing in hands-free mode;
- Unlock the driver's door only;
- Automatic recommendation;
- Silent locking;
- Automatic opening/closing;
- Automatic Deployment of Door Mirrors;

g) "RESET".



function activated



function deactivated

Once a line has been selected, press the switch **6 "OK"** to modify the function.

If you select either "PARKING ASSIST" then "VOLUME" or "DASHBOARD" then "LANGUAGE", you will have to make a further selection (Park Assist sound volume or instrument panel language). In this case, make your selection and confirm it by pressing the switch **6 "OK"**, the selected value is

shown by a  in front of the line.

To exit the menu, press switch **4** or **5** to access "BACK" and confirm by pressing switch **6 "OK"**. It may be necessary to carry out this operation more than once.



The vehicle settings personalisation menu cannot be used when driving. At a speed exceeding 12 mph (20 km/h), the instrument panel display switches automatically back to trip computer and warning system mode.

TRIP COMPUTER

Clock and outdoor temperature

Vehicles fitted with a multimedia screen.



The time and exterior temperature are displayed on the multimedia screen **1**. Refer to the multimedia instructions.



Vehicles not fitted with a multimedia screen

Press switch **2** as many times as required to reach the "Vehicle" tab.

Repeatedly press control **3** or **4** to set the clock.

Press and hold switch **5** "OK" until the time display flashes.

Set the hour using the **3** or **4** control, then wait for three seconds: the minutes will flash.

Set the minutes using the **3** or **4** control, then wait for three seconds: the flashing stops and the time setting is complete.

Exterior temperature indicator

Special feature:

When the exterior temperature is between $-3\text{ }^{\circ}\text{C}$ and $+3\text{ }^{\circ}\text{C}$, the $^{\circ}\text{C}$ characters flash (signalling a risk of ice on the road).

 If the power supply is cut (battery disconnected, supply wire cut, etc.), the clock must be reset. We recommend that you do not adjust these settings while driving.



Exterior temperature indicator

As ice formation is related to climatic exposure, local air humidity and temperature, the external temperature alone is not sufficient to detect ice.

2

WARNING LIGHTS

Instrument panel *A* or *B*

2 The presence and operation of the warning lights **DEPEND ON THE EQUIPMENT AND COUNTRY.**



If no lights or sounds are apparent, this indicates a fault in the instrument panel. It is therefore essential to stop immediately (as soon as traffic conditions allow). Ensure that the vehicle is correctly immobilised and contact an approved Dealer.



Warning light  means you should drive **very carefully to an approved Dealer as soon as possible.** If you fail to follow this recommendation, you risk damaging your vehicle.



For your own safety, the **STOP** warning light requires you to stop immediately, as soon as traffic conditions allow. Switch off the engine and do not restart it. Call an approved Dealer.



Brake circuit fault warning light

It lights up when the ignition or the engine is switched on and goes off after a few seconds.

If it comes on during braking and is ac-

companied by the **STOP** warning light and a beep, it indicates that the fluid level in the circuit is low or that

WARNING LIGHTS

there is a braking system fault. Stop as soon as traffic conditions allow and consult an approved Dealer.

Urgent stop warning light

This lights up when the ignition is switched on and goes out as soon as the engine is started. It lights up at the same time as other warning lights, and is accompanied by a beep.

For your own safety, it requires you to stop immediately, as soon as traffic conditions allow. Switch off the engine and do not restart it.

Call an approved Dealer.

Warning light

This lights up when the ignition is switched on and goes out as soon as the engine is started. It may come on in conjunction with other warning lights on the instrument panel.

It means you should **drive very carefully** to an approved Dealer as soon as possible. If you fail to follow this recommendation, you risk damaging the vehicle.

Coolant temperature warning light

This lights up blue when you switch on the ignition or start the engine.

If it turns red, stop and let the engine idle for a minute or two.

The temperature should drop and the warning light should switch off or turn blue again. Otherwise, stop the engine. Let the engine cool down before checking the coolant.

Call an approved Dealer.

Oil pressure warning light

It lights up when the ignition or the engine is switched on and goes off after a few seconds.

If it lights up while on the road and is

accompanied by the  warning light and a beep, you must stop the vehicle and switch off the ignition.

Check the oil level → 320.

If the level is correct, the light has come on for another reason: contact an approved Dealer without delay.

Indicator light for Airbag

This comes on when the ignition is switched on and goes out after a few seconds. If it does not light up when the ignition is switched on, if it lights up when the engine is on, or if it flashes, this indicates that there is a fault in the system.

Contact your approved Dealer straight away.

LPG indicator light → 31

Low fuel level warning light

It lights up orange when the ignition or the engine is switched on then, depending on the vehicle, goes off after a few seconds or is displayed in white. If it appears in orange during driving and a beep sounds, fill the tank with at least 1.76 gal (8 litres) of fuel. There is only approximately 31 miles (50 km) worth of fuel left.

LPG low fuel level warning light → 31

Gear change indicator

This lights up to advise you to change to a higher gear (arrow pointing upwards) or lower gear (arrow pointing downwards) → 192.

Anti-lock braking warning light

This lights up when the ignition is switched on and goes out after a few seconds.

If it does not go out after the ignition is switched on, or lights up when driving, there is a fault with the ABS. Braking

WARNING LIGHTS

will then be as normal, without the ABS. Contact your approved Dealer straight away.

Battery charge warning light

It lights up when the ignition or the engine is switched on and goes off after a few seconds.

If it comes on on the road, accompan-

ied by the **STOP** warning light and a beep, this indicates an overload or discharge in the electrical circuit.

Stop as soon as traffic conditions allow and consult an approved Dealer.

Warning light for the electronic stability control (ESC) and traction control system

This lights up when the ignition is switched on and goes out after a few seconds.

The → 208 warning light may appear for several reasons.

ESC OFF warning light

→ 208

Traction control warning light

→ 208

Lane departure prevention system warning light → 214

Cruise control warning lights → 254

Speed limiter warning light → 251

Overspeed warning light

A beep will sound and the warning light will come on if the vehicle exceeds 75 mph (120 km/h).

Door(s) open warning light → 50

Engine standby warning light → 168

Engine standby unavailable warning light → 168

Mode indicator light ECO

This comes on when ECO mode is activated → 192.

Freewheel indicator light

Depending on the vehicle, it lights up in grey then in green when the vehicle automatically starts "freewheeling", in

order to optimise fuel consumption → 192.

Warning light

If it appears in red during driving and is

accompanied by the **STOP** indicator light, you must, for your safety, stop as soon as traffic conditions allow. Switch off the engine and do not restart it.

Call an approved Dealer.

If it appears in yellow during driving

and is accompanied by the  warning light, visit an Approved Dealer as soon as possible. **Meanwhile, drive with care.** If you fail to follow this recommendation, you risk damaging your vehicle.

Parking brake and Electronic parking brake applied warning light → 180.

Tyre under-inflation warning light

This lights up when the ignition is switched on or when the engine starts, then disappears after a few seconds → 202 → 197.

Brake pedal warning light

WARNING LIGHTS

This lights up when the brake pedal should be pressed → 175.



Hill descent control indicator light → 208.



Warning light to indicate a fault or unavailability of "Active emergency braking" function → 231



Warning light of the "Active emergency braking" function → 231



Side light indicator light



Main beam headlight indicator light



Dipped beam headlight indicator light



Automatic main beam headlight warning light → 142



Front fog light indicator light



Rear fog light indicator light



Left-hand direction indicator tell-tale light



Right-hand direction indicator tell-tale light



Headlight adjustment warning light



Emission control system warning light

On vehicles that are equipped, this light comes on when the engine is started and, depending on the vehicle, when the ignition is switched off while the engine is in the standby phase → 168, before going out.

- If it lights up continuously, contact an approved Dealer as soon as possible;
- If it flashes, reduce the engine speed until the light stops flashing. Contact an approved Dealer as soon as possible → 191.



Preheating warning light (Diesel version)

This should come on when the ignition is switched on. It indicates that the heater plugs are in operation.

It goes out when preheating is complete. The engine can be started.



Variable power assisted steering warning light

It lights up when the ignition or the engine is switched on and goes off after a few seconds.

Depending on the vehicle, it lights up in the event of a battery fault → 348.

If it comes on while driving, alongside

the warning light **STOP**, this means there is a system fault.

Call an approved Dealer.



Particle filter system warning light → 187, → 185



Warning light for reagent level and faults in the exhaust gas reduction system → 157



Depending on the vehicle, the "Driver vigilance warning" or "Driver attention warning" or "Driver fatigue warning" function fault warning light



Electrotechnical system warning light

It lights up along with the **STOP** warning light and a beep sounds when the electrical assembly temperature is too high. Stop the vehicle and switch off the ignition. Consult an approved Dealer.

WARNING LIGHTS

If it lights up accompanied by the

STOP warning light, a beep and the "EVACUATE IN SAFETY" message, switch off the ignition and do not restart the vehicle. Leave the vehicle and consult an approved Dealer.



The "EVACUATE IN SAFETY" message accompanied by the

STOP warning light and a beep indicates that for your safety you must stop the vehicle immediately, depending on the traffic conditions. Switch off the ignition. Leave it switched off. Exit the vehicle, get all passengers out of the vehicle and keep them away from the vehicle and traffic. **Fire hazards.**



If the vehicle is parked on the hard shoulder, you must warn other road users of your vehicle's presence with a warning triangle or with other devices as per the legislation applying to the country you are in.



Traction battery fault warning light

If it appears, accompanied by the



warning light, this indicates a fault related to the operation of the traction battery. Contact your approved Dealer straight away.



Traction battery gauge warning light

This appears in yellow when the traction battery charge level has reached the reserve level → 124.



Electric operating mode indicator light

It is displayed when only the electric motor and traction battery are powering the movement of the vehicle → 24.



Electrotechnical system fault warning light

When it comes on, this indicates an electrotechnical fault related to the electrical assembly (traction battery and electric motor).

Contact your approved Dealer straight away.



Electric motor fault warning light

When it comes on, this indicates a fault with the electrotechnical system linked to the electric motor. Contact your approved Dealer straight away.



If no lights or sounds are apparent, this indicates a fault in the instrument panel. It is therefore essential to stop immediately (as soon as traffic conditions allow). Ensure that the vehicle is correctly immobilised and contact an approved Dealer.

WARNING LIGHTS



On display **C**



Airbag (passenger) ON → 105



**Airbag (passenger) OFF →
105**



**Seat belt reminder warning
light → 66**

STEERING

Adjusting the steering wheel



The steering wheel height and, depending on the vehicle, depth can be adjusted.

Push the lever **1** downwards and set the steering wheel to the desired position, then raise the lever to lock the steering wheel.

Make sure that the steering wheel is correctly locked.



For safety reasons, carry out any adjustments while the vehicle is stationary.

Steering wheel heating

(depending on the vehicle)



This function heats the steering wheel **2**.

Operating principle

When the temperature is reached, the function regulates the temperature of the heated areas for approximately 30 minutes and then switches off automatically.

Activating the function

With the ignition on, press the switch **3**: the switch warning light illuminates.

Deactivating the function

- **Automatically:**

The function switches off automatically after the regulation phase of approximately 30 minutes. The indicator light of the switch **3** goes out.

Note: if the function has switched off automatically, press the switch **3** twice to reactivate it.

If the switch **3** is not pressed again, the function will be reactivated the next time the ignition is switched on.

- **Manually:**

To deactivate the function during the regulation phase, press the switch **3**. The indicator light of the switch **3** goes out.

Power-assisted steering

Never drive with an inadequately charged battery.

Special case

Depending on the vehicle, in the event of a battery fault (disconnected, discharged battery, etc.), the power-assisted steering wheel angle must be reset. To do this:

- the vehicle stationary and on flat ground;
- with the driver alone in the vehicle,

start the engine: the  warning light and/or, depending on the vehicle,

STEERING

the "Turn steer.wheel max right-left" message are/is displayed on the instrument panel;

- turn the steering wheel fully to the left and hold it, exerting pressure at the end of travel for about one second (you may then feel the steering wheel move in the opposite direction);
- repeat the same operation by turning the steering wheel fully to the right;
- bring the steering wheel back to the left in order to straighten the wheels.



Never leave the steering wheel on full lock when the vehicle is stationary.



With the engine switched off, or if there is a system fault, it is still possible to turn the steering wheel. The force required will be greater.



Never switch off the ignition when travelling downhill, and avoid doing so in normal driving (power steering and brake servo will not function).

Special feature of the Stop and Start

(depending on the vehicle)

With the engine on standby, power-assisted steering is no longer operational. It returns to its original state when the engine is restarted or as soon as the speed is above 0.62 mph (1 km/h) (hill, slope, etc.).

REAR VIEW

Rear view mirrors

2

Exterior rear view mirrors with manual adjustment



To adjust the door mirror, move the stalk **1**.

Folding exterior rear view mirrors

Fold the rear view mirror manually against the door window.

Electric door mirrors



Adjustment

When you select the door mirror using the switch **3**, the warning light built into the switch will appear. Then use the button **2** to adjust it to the desired position.

Heated rear view mirrors

While the engine is running, mirror de-icing is activated simultaneously with the de-icing or demisting of the rear screen → **281** → **285**.

Electrical folding mirrors

Note: you can deactivate/activate the folding of the door mirrors → **128**.

You can make the door mirrors fold in (switch **4** in position **B**) or fold out (switch **4** in position **A**).



Objects observed in the rear view mirror glass are actually closer than they appear. For your safety, take this into account in order to correctly assess the distance before any manoeuvre.

Manually folding door mirrors



To fold down the door mirror, pull it towards the door window until you hear a mechanical click.

REAR VIEW

To return the door mirror to its operating position, proceed in the reverse order.

Ensure that it is correctly locked in position.

Special case

When the rear view mirror has been manually deployed or folded back, it is possible to reset it to a usage position. To do this, press the switch **4**. A mechanical noise from the rear view mirror unit will be heard.

If a tapping noise cannot be heard, press the switch **3** again until the tapping noise can be heard from the door mirror.



For safety reasons, carry out any adjustments while the vehicle is stationary.

Interior rear view mirror

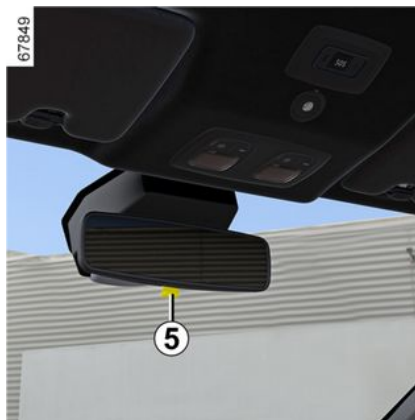

Its position can be adjusted.

Rear view mirror with lever **5**

When driving at night, to avoid being dazzled by the headlights of the vehicle behind, press the small lever **5** located behind the rear view mirror.



For safety reasons, carry out any adjustments while the vehicle is stationary.



Objects observed in the rear view mirror glass are actually closer than they appear. For your safety, take this into account in order to correctly assess the distance before any manoeuvre.

2

LIGHTING AND SIGNALS

Exterior lighting and signals

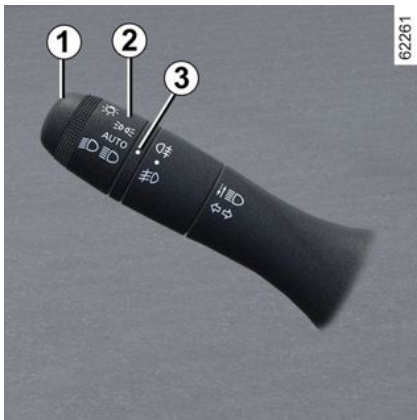

Side lights

 Turn the ring **2** until the symbol is opposite the mark **3**.

An indicator light on the instrument panel will come on.

 When driving on the left-hand side of the road in a left-hand drive vehicle (or vice versa), you must adjust your headlights for the length of your stay → 145.

Daytime running lights function

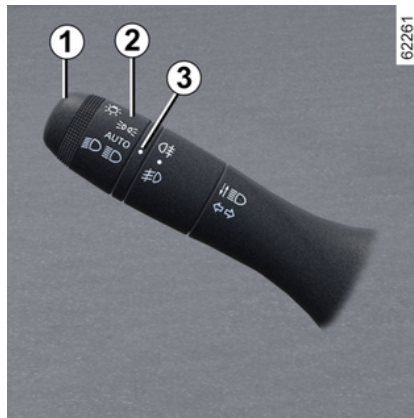

If fitted on the vehicle, the daytime running lights and rear side lights come on automatically without any action on the stalk **1** when the engine is started, and they go off once the engine is switched off.

Special feature: Daytime running light will go out automatically when the indicator is in operation.



Before driving at night, check that the electrical equipment is operating correctly and adjust the headlight beams (if your vehicle is not carrying its normal load). As a general precaution, check that the lights are not obscured (by dirt, mud, snow or objects being transported).

LIGHTING AND SIGNALS

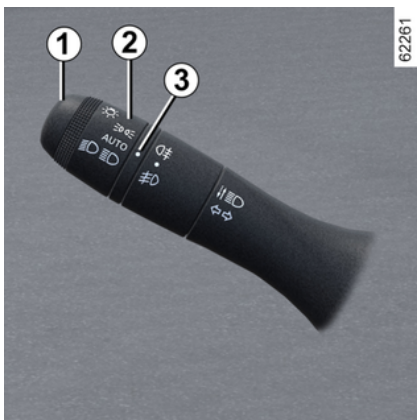

Dipped beam headlights

Manual operation

Turn the ring **2** until the symbol is opposite the mark **3**. This indicator light on the instrument panel comes on.

Automatic operation

(depending on the vehicle)

Rotate the ring **2** until the **AUTO** symbol is aligned with the mark **3**: with the engine on, the dipped beam headlights switch on or off automatically according to the exterior light level, without any action on the stalk **1**.

Main beam headlights

 With the engine running and the dipped beam headlights on, push the stalk **1**. This indicator light on the instrument panel comes on.

To return to the dipped beam headlights position, pull the stalk **1** towards you again.

Automatic main beam headlights

 Depending on the vehicle, this system switches the main beam headlights on and off automatically.

It uses a camera located behind the interior rear view mirror to detect vehicles that are being followed and those coming in the opposite direction.

Note: at night, in urban areas with street lighting, the automatic main beam headlights automatically switch off.

The main beam headlights come on automatically if:

- the exterior light level is low;
- no other vehicle or lighting is detected;
- the vehicle speed is above approximately 25 mph (40 km/h).

If any of the above conditions are not fulfilled, the system switches to dipped beam headlights.

Note: make sure that the windscreen is not obscured (dirt, mud, snow, condensation, etc.).

To activate the automatic main beam headlights

Rotate the ring **2** until the **AUTO** symbol is aligned with the mark **3** and push the stalk **1**.

Warning light  comes on the instrument panel.

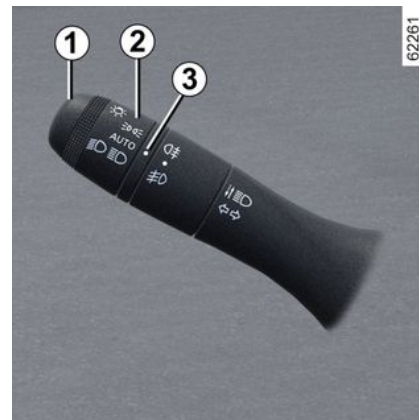

LIGHTING AND SIGNALS



To deactivate the automatic main beam headlights:

– rotate the ring **2** to a position other than AUTO;

or

– pull the stalk **1**.

Warning light  goes out on the instrument panel.

Note: the main beam headlights will be activated upon deactivation of the automatic main beam headlights function.



The system may encounter difficulties under certain conditions, including:

- extreme weather conditions (rain, snow, fog, etc.);
- obstruction in front of the wind-screen or camera;
- when a following or oncoming vehicle has weak or hidden lighting;
- incorrect settings for the front headlights;
- reflecting systems;
- ...

Operating faults

When the "Check Automatic Lighting" message appears on the instrument panel, the system is deactivated.

Consult an approved Dealer.

Switching off the dipped beam headlights

There are two possibilities:

– manually, move the ring **2** to posi-

tion  or, depending on the vehicle, to position **0**;

– the lights will go out automatically when the engine is switched off, the driver's door is opened or the vehicle is locked. In this case, when you start the engine the lights will be switched back on according to the position of the ring **2**, taking into account the exterior light level, without moving the stalk **1**.

Lights-on reminder audible alarm

If the lights are on after the engine is switched off, a warning beep sounds when the driver's door is opened to warn you that the lights are still on (to avoid draining the battery).

Welcome and goodbye function

(depending on the vehicle)

Once the function is activated, the daytime running lights and the rear side lights will light up automatically upon detection of the card or when the vehicle is unlocked.

They switch off automatically:

– approximately one minute after lighting up;

– when starting the engine, based on the position of the lighting stalk;

or

– upon locking the vehicle.

Activating/deactivating the function

To activate or deactivate the external welcome function, please see the multimedia instructions.

Choose "**ON**" or "**OFF**".

LIGHTING AND SIGNALS

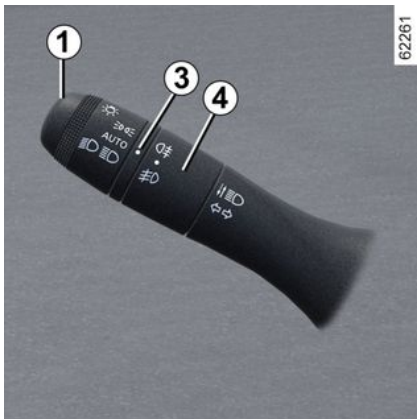

Front fog lights

☞ Turn centre ring **4** on the stalk **1** until the symbol faces mark **3**, then release it.

Operation of the fog lights depends on the exterior lighting selected, and an indicator light will light up on the instrument panel.

Rear fog light

☞ Turn centre ring **4** on the stalk until the symbol faces mark **3**, then release it.

Depending on the vehicle, the stalk returns to the initial position or stays in position.

Operation of the fog lights depends on the exterior lighting selected, and an indicator light will light up on the instrument panel.

To avoid inconveniencing other road users, remember to switch off this light when it is no longer needed.

i When driving in fog or snow, or when transporting objects which are higher than the roof, the headlights do not come on automatically. The fog lights are controlled by the driver: indicator lights on the instrument panel inform you whether they are on (indicator light on) or off (indicator light off).

Turning off the fog lights

There are two possibilities:

– manually, depending on the vehicle, turn centre ring **4** again until mark **3** is opposite the symbol for the fog light that you wish to switch off. The corresponding indicator light will go out on the instrument panel;

– the lights will go out automatically when the engine is switched off or the vehicle is locked, and the fog lights when the driver's door is opened.

The front and rear fog lights switch off when the exterior lights are switched off.

Headlight beam adjustment



Control **A** is used to adjust the height of the headlight beams according to the load.

Turn the control **A** downwards to lower the headlights and upwards to raise them.

LIGHTING AND SIGNALS

Table of example positions for adjusting the position according to the load

	Examples of positions for adjusting the control A according to the load			
	5-seat estate versions	7-seat estate versions	5-seater hybrid versions	7-seater hybrid versions
Driver alone or with front passenger	0	0	0	0
Driver with one front passenger and two rear passengers	1	1	1	1
Driver with one front passenger and three or five rear passengers	1	1	1	1
Driver with a front passenger and three or five rear passengers as well as luggage	3	2	3	2
Driver with luggage or load reaching the maximum authorised load weight	3	2	3	2

The table below gives some examples. In all cases, adjust the control **A** according to the vehicle load so that the road can be seen and other drivers are not dazzled.

AUDIBLE AND VISUAL SIGNALS

Horn



Press one of the the locations **A**.

Headlight flasher

To flash the headlights, pull the stalk **1** towards you, then release.



Hazard warning lights



Press the switch **2**.

This switch activates all four direction indicators and the side indicator lights simultaneously.

It must only be used in an emergency to warn drivers of other vehicles that you have had to stop in an area where stopping is prohibited or unexpected, or that you are obliged to drive under special conditions.

Direction indicators



Move stalk **1** parallel to the steering wheel and in the direction you are going to turn it.

One-touch mode

Briefly push the stalk **1** upwards or downwards without exceeding the point of resistance, then release it: the stalk will return to its original position and the relevant direction indicator light will flash three times.

2

WIPER

Windscreen wash, wipe

2 Vehicle fitted with intermittent windscreen wipers



A. a single sweep of the wipers

A brief push will trigger one sweep of the wipers.

B. off

C. intermittent wiping

The wipers will pause for several seconds between sweeps.

D. slow continuous wiping

E. fast continuous wiping

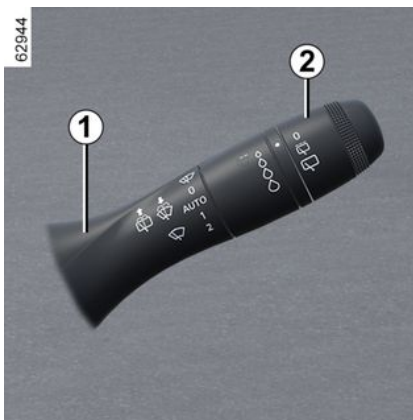

Special feature

When driving the vehicle, the wiping speed slows down whenever the vehicle stops. For example, fast wiping speed will slow to normal wiping speed. As soon as the vehicle moves off, wiping will return to the speed originally selected.

Any action on the stalk **1** overrides and cancels the automatic function.

Note: when washing the vehicle using a carwash, return the ring **2** on the stalk **1** to the off position in order to deactivate wiping.

Note: after use, remember to return the ring **2** on the stalk **1** to the off position in order to ensure that wiping is

not activated automatically upon the next use.

Vehicle fitted with windscreen wiper rain sensor



The rain sensor is located on the windscreen, in front of the interior rear view mirror.

A. a single sweep of the wipers

A short push will trigger one sweep of the wipers.

B. off

C. automatic wiper function (depending on the vehicle)

When this position is selected, the system detects water on the windscreen

WIPER

and triggers the wipers at a suitable wiping speed.

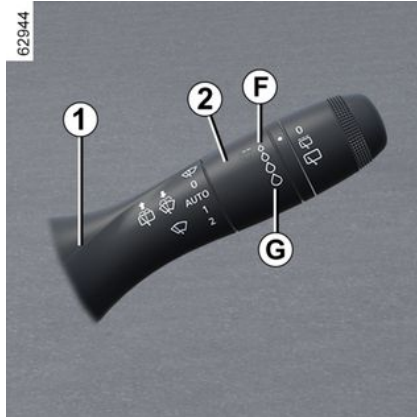

It is possible to change the triggering threshold and the time duration between sweeps by rotating the ring:

- **F**: minimum sensitivity;
- **G**: maximum sensitivity.

The higher the sensitivity, the quicker the wipers will react and the faster the wipe.

When activating automatic wiping or when increasing sensitivity, one sweep of the blades is performed.

Note:

– the rain sensor is only intended as a driving aid. In the event of reduced visibility, the driver should manually activ-

ate the wipers. In foggy weather or during snowfalls, wiping is not automatically triggered and remains under the driver's control;

- in the event of temperatures below zero, automatic wiping is not activated when the vehicle is started. It is automatically activated as soon as the vehicle exceeds a certain speed (approximately 5 mph (8 km/h));
- do not activate automatic wiping in dry weather;
- fully de-ice the windscreen before activating automatic wiping;
- when washing the vehicle under a roller type car wash, set the stalk **1** to position **B** to deactivate automatic wiping.

If your vehicle is equipped with a vehicle settings customisation menu, you can opt to activate or deactivate this function → 128.

For vehicles not fitted with a settings customisation menu, you can have this function deactivated by an approved Dealer.

Operating faults

In the event of a malfunction of the automatic wiping, the wiper is set to intermittent wiping. Call an approved Dealer.

The rain sensor operation may be interrupted in the event of:

- damaged windscreen wipers: a film of water or traces left by a blade in the sensor's detection zone may increase the response time of the automatic wiper, or increase the wiping frequency;
- a windscreen with any chip or crack near the sensor, or a windscreen covered in dust, dirt, insects, ice, the use of washing wax and water-repellent chemicals. In this case the windscreen wiper will be less sensitive or may even not react at all.



D. slow continuous wiping

E. fast continuous wiping

Special feature

When driving the vehicle, the wiping speed slows down whenever the

WIPER

vehicle stops. For example, fast wiping speed will slow to normal wiping speed. As soon as the vehicle moves off, wiping will return to the speed originally selected.

Any action on the stalk **1** overrides and cancels the automatic function.

Precautions

- In the event of ice, check whether the blades are stuck to the windscreen before operating the wiping mechanism. If you activate the wipers while the blades are stuck down with ice, you may risk damaging both the blade and the wiper motor.
- Do not activate the wipers on a dry screen. This will lead to premature wear or damage to the blades.

Specific front wiper position (service position)

This position enables the blades to be lifted to remove them from the windscreen.

It may be useful to:

- clean the blades;
- release the blades from the windscreen in winter;
- replace the blades → **366**.

With the ignition on or engine started, lift the stalk **1** twice to position **A** (single sweep). The blades stop slightly away from the bonnet.

To return the blades to the lowered position, with the ignition on, ensure that the wipers have folded down onto the windscreen, then move the stalk **1** to position **A** (single sweep).

Before switching on the ignition, place the wipers on the windscreen to avoid the risk of damage to the bonnet or the wipers when they are switched on.



Before any action involving the windscreen (washing the vehicle, de-icing, cleaning the windscreen, etc.) return the stalk **1** to position **B** (off).

Risk of injury and/or damage.



In the event of obstacles on the windscreen (dirt, snow, ice, etc.), clear the windscreen (including the central area located behind the interior rear view mirror) before starting the wipers (risk of motor overheating). If an object is preventing a blade from moving, it may stop functioning. Remove the obstacle and reactivate the wiper using the wiper stalk.

WIPER

Windscreen washer



With the ignition on, pull the stalk **1** then release.

A longer pull will trigger, in addition to the windscreen washer, two sweeps of the wipers followed, a few seconds later, by a third.

Note: in temperatures below zero, the washer liquid may freeze on the windscreen, reducing visibility. Heat the windscreen using the demister control before cleaning.



When working in the engine compartment, ensure that the windscreen wiper stalk is in position

B (off).

Risk of injury.



Efficiency of a wiper blade

Check the condition of the wiper blades. How long they last depends on you:

- it must remain clean: clean the blade and the screen regularly with soapy water;
- do not use it when the screen is dry;
- free it from the screen when it has not been used for a long time.

In all cases, replace it as soon as it begins to lose efficiency: approximately once a year → **366**.

Precaution for using the wipers

- In freezing or snowy conditions, clear the screen before starting the wipers (risk of motor overheating);
- ensure that no objects are obstructing the travel of the blade.

WIPER

Rear windscreen wash, wiper

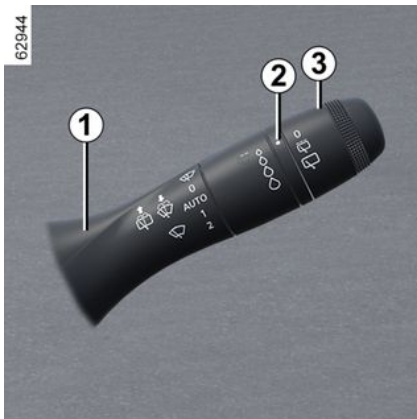

Rear screen wiper



With the ignition on, rotate the ring **3** on the stalk **1** until the symbol is opposite the mark **2**

- **off**
- **intermittent wiping**

The wipers will pause for several seconds between sweeps. The wiping frequency varies according to the vehicle speed;

- **slow continuous wiping**

To stop the operation, rotate the ring **3** again.

Note:

152 - Getting to know your vehicle

When washing using a roller type car wash, return the ring **3** on the stalk **1** to the stop position to deactivate wiping.

Note:

At the end of use, remember to return the ring **3** on stalk **1** to the off position, so that wiping is not inadvertently activated during the next use.



Do not hold the wiper arm when opening or closing the luggage compartment door.



Before taking any action involving the rear screen (washing the vehicle, de-icing, cleaning, etc.) return the stalk **1** to the off position.
Risk of injury and/or damage.



Wiper blade performance

Check the condition of the wiper blades. How long they last depends on you:

- it must remain clean: clean the blade and the screen regularly with soapy water;
- do not use it when the screen is dry;
- free it from the screen when it has not been used for a long time.

In all cases, replace it as soon as its performance is reduced: approximately once a year → **366**.

Precaution for using the wipers

- In freezing or snowy conditions, clear the screen before starting the wipers (risk of motor overheating);
- ensure that no objects are obstructing the travel of the blade.

Activation/deactivation of the rear screen wiper

Engaging reverse gear triggers intermittent wiping (if the front wipers are working). If your vehicle is equipped with a vehicle settings customisation

WIPER

menu, you can opt to activate or deactivate this function → **128**.

For vehicles not fitted with a settings customisation menu, you can have this function deactivated by an approved Dealer.

If obstacles are present on the rear window (dirt, snow, etc.), the wiper will try to sweep away all the obstacles. If an obstacle prevents the blade from moving, it can be stopped. Remove the obstacle, wait for around 30 seconds and reactivate the wiper using the wiper stalk.

Precautions

- If the weather is icy, check that the blade is not stuck to the windscreen before operating the wipers. If you activate the wiper while the blade is blocked by ice, you risk damaging both the blade and the wiping motor.
- Do not operate the wipers on a dry screen as this will cause premature wear or damage to the blades.



Rear screen wash/wipe



With the ignition on, push and hold the stalk **1** then release it.

Holding the stalk for longer will trigger (in addition to the windscreen washer) two sweeps of the rear wiper followed, a few seconds later, by a third (drip wiping function).

When the stalk is released, it returns to the rear screen wiper position.

FUEL TANK

Petrol and diesel versions

2

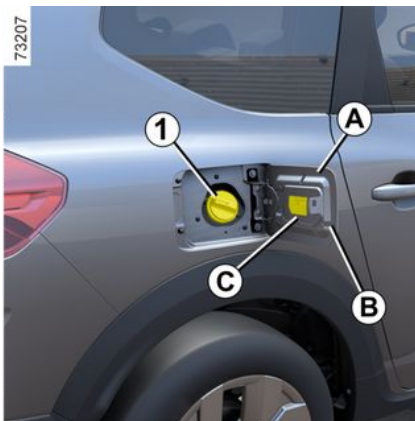

Useful capacity of fuel tank: approximately 50 litres.

Depending on the vehicle, to open the fuel filler flap **A**, place your finger in opening **B**.

To close it, press the fuel filler flap **A** by hand, as far as it will go. On some vehicles, the cap **1** can be unlocked with the ignition key. Otherwise, it is connected to the vehicle by a strip of plastic. For details on filling the tank, refer to the information on "Filling with fuel".



Depending on the vehicle, lift lever **2** to unlock the fuel filler flap **A**. Open it, then unscrew the fuel tank cap **1**.

There is a cap holder **3** on the filler flap for holding the cap when the tank is being filled.

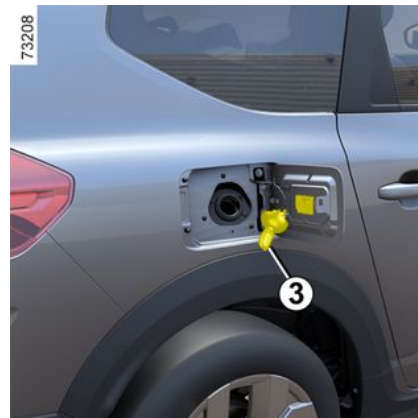

Fuel filler cap: this is a specific type. If you

have to replace it, make sure the new cap is of

the same type as the original.

Contact an approved Dealer.

Never place the cap near a source of heat or flame.

Do not wash the filler area with a high-pressure washer.

Fuel grade

Use a high-grade fuel that complies with the legislation in force in each country. It must conform to the spe-

FUEL TANK

cifications shown on the label **C** inside the fuel filler flap → 379.

Petrol version

It is essential to use unleaded petrol. The octane rating (RON) should match the information given on the label **C** located inside the fuel filler flap → 379.

Diesel version

It is essential to use diesel fuel that conforms to the specifications shown on the label **C** inside the fuel filler flap → 379.



Fuels that comply with the European standards with which vehicle engines marketed in Europe are compatible → 379.



To fill up with fuel, the engine must be switched off (and not only on standby in the case of vehicles equipped with the Stop and Start function): you must switch off the ignition → 162, → 164.
Fire hazard.



Do not mix even small amounts of petrol (unleaded or E85) with diesel.

Do not use ethanol-based fuel if your vehicle is not compatible with this fuel.

Do **not** add reagent to the fuel – otherwise you risk damaging the engine → 154. If you wish to add an additive to the fuel, use a product approved by our Technical Department.
Consult an approved Dealer.



No modifications whatsoever are permitted on any part of the fuel supply system (electronic unit, wiring, fuel circuit, injector, protective covers, etc.) as this may be dangerous (unless undertaken by qualified Network personnel).



Please note when working close to the engine that it may be hot. The engine cooling fan may also start at any moment. The



label in the engine compartment reminds you of this.
Risk of injury.

Filling with fuel

With the ignition off, **fully** insert the nozzle before pulling the trigger to fill the fuel tank (avoid the risk of splashing).

Keep the nozzle in this position throughout the entire filling operation. When the pump cuts out automatically at the end of the filling procedure, a maximum of two further filling attempts may be made, as there must be sufficient space in the fuel tank to allow for expansion.

Make sure that no water enters the fuel tank during filling.

After filling, refit the cap **1** and close the filler flap **A** to avoid any water or foreign bodies from entering the system.

FUEL TANK

Always make sure that the cap **1**, the flap **A** and its perimeter remain clean and free of dust, mud, dirt, etc.

Special case

When the vehicle has been stopped for around three months, **you must add fuel to prevent damage to the fuel pump.**

To do this, with the ignition off, fill up with fuel or add at least **approximately 2.20 gallons (10 litres)**, then start the engine to operate the pump and renew the fuel in the circuit.

If it is not possible to add at least 1.10 gallons (5 litres) of fuel due to the fuel level in the tank, drive the vehicle until the tank has capacity.

Petrol version

Using leaded petrol will damage the antipollution system and may lead to a loss of warranty.

To ensure that the fuel tank is not filled with leaded petrol, the fuel tank filler neck contains a restrictor fitted with a foolproof system which **only allows the nozzle for unleaded petrol to be used** (at the pump).



Persistent smell of fuel

If you notice a persistent fuel odour you should:

- stop the vehicle when traffic conditions allow it and switch off the ignition;
- switch on the hazard warning lights and ask your passengers to leave the vehicle and stay clear of the traffic;
- contact an authorised dealer.

LPG version

Useful capacity of LPG tank: approximately 8.80 gal (40 l) or 11.00 (50 l) (depending on the vehicle).

REAGENT TANK

Please ensure that you comply with the legislation of your country.

It is important to remember that failure to respect regulations in force could lead to legal action being taken against the vehicle owner.

Operating principle

The reagent is intended for Diesel engines fitted with the SCR (selective catalytic reduction) system.

Using a reagent reduces the quantity of nitrogen oxides in exhaust gases.

Reagent consumption in real time depends on vehicle usage conditions, the equipment fitted, and driving style.

Reagent quality

Only use **reagents which comply with the ISO 22241** standard and in accordance with the mark on the tank cap.



To fill up with reagent, the engine must be stopped (not just on standby in the case of vehicles with the Stop and Start function). You must switch off the ignition ➔ 162, ➔ 164.



If the "xxxKM LOCKOUT FILL ADBLUE" message appears, fill the reagent tank and refer to the filling instructions.

Risk of immobilisation of the vehicle.

Topping up

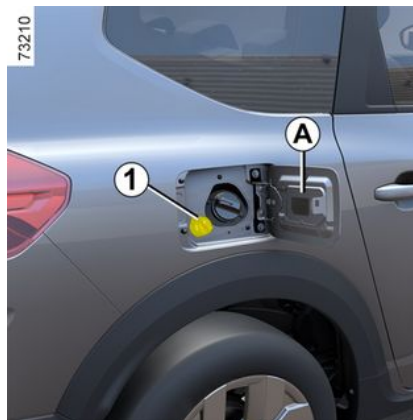

Useable capacity of the tank:

11 litres approximately.

With the ignition switched off, open the flap **A** then unscrew the cap **1**.

Note: ammonium hydroxide vapour may escape from the cap opening when the tank temperature is high.

The tank can be filled at the pump. With the ignition off, insert the nozzle and insert it **fully** before turning it on to fill the fuel tank (risk of splashing).

Keep the nozzle in this position throughout the entire filling operation.

When the pump cuts out automatically at the end of the filling procedure, a maximum of two further filling attempts may be made, as there must be sufficient space in the fuel tank to allow for expansion.

In other filling cases, it is essential to read the information shown on the reagent container (e.g. the can or bottle).



Fuel filler cap: this is a specific type.

If you have to replace it, make sure it is identical to the original cap. Contact an approved Dealer. Do not wash the filler area with a high pressure washer.

Precautions for use

When filling:

REAGENT TANK

- **handle the reagent with care. They can damage clothes, shoes, bodywork components etc.**
- make sure that no water enters the fuel tank.

If the reagent overflows, or contaminates any paintwork, clean the affected area quickly with plenty of cold water and a soft cloth.

Note: if the reagent fluid crystallises, use a soft sponge.



The reagent must not come into contact with eyes or skin. If it does, wash the affected area with plenty of cold water. If necessary, consult a doctor.

**In extreme cold weather conditions
In frosty weather conditions, the reagent tank should be refilled as**

soon as the  warning light and the "FILL ADBLUE BEFORE 745 miles (1,200 km)" message is displayed on the instrument panel.

Special cases

The reagent fluid freezes below approximately -10°C.

In these conditions, do not attempt filling when the fluid is frozen. In the event of needing to top up or fill the

tank with reagent ( on), park the vehicle in a hotter location if possible so that the reagent becomes liquid again. Otherwise, have a qualified professional top up or fill up with reagent fluid.



After filling the reagent tank, check that the cap and cover are closed, start the engine and **WAIT 10 seconds with the vehicle stationary, engine on**, before setting off again. If this operation is not carried out, the filling of the tank will not be taken into account automatically until after several dozens of minutes of driving. The "FILL ADBLUE" message and/or the warning lights will continue to appear until the filling has been registered by the system.





No work whatsoever is permitted on any part of the system. To prevent damage, only qualified personnel from our network may work on the system.

REAGENT TANK

Maintenance/Range

The information displayed on the instrument panel may be accompanied by a beep.







2

Indicator lights	Message	What to do?
-	"FILL UP WITH ADBLUE BEFORE 1,488 miles (2,400 km)"	When the message is displayed when the ignition is switched on, you have less than 1,488 miles (2,400 km) range . Fill or have an Approved Dealer fill or top up the reagent in the tank.
 comes on.	"FILL UP WITH ADBLUE BEFORE 744 MILES (1,200 KM)"	When the message is displayed when the ignition is switched on, you have between 744 miles (1,200 km) and 496 miles (800 km) range . Fill or have an Approved Dealer fill or top up the reagent in the tank.
 comes on.	"xxxKM LOCKOUT FILL ADBLUE"	The message is displayed when the ignition is switched on and is repeated: - approximately every 62 miles (100 km), you have a range of between about 496 miles (800 km) and 124 miles (200 km) ; - approximately every 31 miles (50 km), you have less than 124 miles (200 km) range . In any event, fill or have an Approved Dealer fill the reagent tank as soon as possible .
 comes on.	"0 MILES (0 KM) LOCKOUT FILL ADBLUE"	The engine will not start. To restart, you must fill the reagent tank yourself.

REAGENT TANK

System faults

The information displayed on the instrument panel may be accompanied by a beep.

Indicator lights	Message	Readings
 and  illuminate.	"CHECK EMISSION CONTROL" "CHECK ADBLUE QUALITY" "CHECK ADBLUE INJECTION"	Indicates a fault in the system. Contact your approved Dealer as soon as possible.
 and  illuminate.	"xxxKM LOCKOUT EMISSION CONTROL"	Indicates a system fault and that in less than 496 miles (800 km) it will become impossible to restart the vehicle. These warnings are repeated: -every 62 miles (100 km) until there are between 500 miles (800 km) and 124 miles (200 km) remaining until the vehicle cannot be restarted; - every 31 miles (50 km) when there is less than 124 miles (200 km) left before the vehicle cannot be restarted. Contact your approved Dealer as soon as possible.
 and  illuminate.	"0 MILES (0 KM) EMISSION CONTROL LOCKOUT"	Indicates that after the ignition is switched off the vehicle will not restart. Call an approved dealer.

RUNNING IN

Petrol version

For the first **620 miles** (1,000 km), do not exceed 81 mph (130 km/h) in the highest gear.

You can only expect top performance from your vehicle after approximately **1,860 miles (3,000 km)**.

Service intervals: refer to the vehicle's maintenance document.

Diesel version

For the first **930 miles (1,500 km)**, do not exceed 80 mph (130 km/h) in the highest gear, or 2,500 rpm. After completing this mileage you may drive faster, although you may only expect top performance after approximately 3,600 miles (6,000 km).

During the running in period, do not accelerate hard while the engine is still cold and do not let the engine over-rev.

Service intervals: refer to your vehicle's maintenance document.

Note: for a new vehicle in the running-in phase: the coolant level may be higher than the "MAXI" mark on the tank, then drop to between the "MINI" and "MAXI" marks.

This does not present a risk.

STARTING, STOPPING THE ENGINE

Ignition-starter switch on a vehicle with key

"Stop and steering lock applied" position A

To lock: remove the key **1** and turn the steering wheel until the steering column locks.

To unlock: turn the key and the steering wheel slightly.

"On" position B

The ignition is switched on:

- **Petrol version:** the engine may be started.
- **Diesel version:** the engine is pre-heating.

"Start" position C



If the engine fails to start at the first attempt, turn the key back before activating the starter again.

Release the key as soon as the engine starts.

Special note on vehicles with an automatic gearbox

➔ 172 ➔ 175.

Starting the engine

Depending on the vehicle, if a gear is engaged, for the engine to be started, you must depress the clutch pedal or put the gear lever in neutral. The

"Neutral + START" message appears on the trip computer to notify you.

In very cold conditions (temperatures below -20°C): to make it easier to start the engine, switch on the ignition for several seconds **before** starting the engine.

In the event of starting the engine in very low exterior temperatures (below -10°C): hold down the clutch pedal until the engine starts.

On a vehicle equipped with an automatic gearbox, before starting, set the lever to **P** or **N** position and press the brake pedal. ➔ 172.



Petrol version

STARTING, STOPPING THE ENGINE

– Turn the key to the "Start" position **without depressing the accelerator pedal**.

– Release the key as soon as the engine starts.

Diesel version

Turn the ignition key to the "On" position **B** and hold this position until the engine preheating warning light goes out.

Turn the key to the "Start" position **C** **without accelerating**.

Release the key as soon as the engine starts.

Stopping the engine

With the engine idling, turn the key to the "Stop" position **A**.

Special feature

Depending on the vehicle, accessories (e.g. radio) stop working either when the engine is switched off or when the driver's door is opened or when the doors are locked.



Never start your vehicle while freewheeling on a gradient. Risk of non-activation of power-assisted steering.
There is a risk of accidents.

LPG version

The engine is always started using petrol.



While the fuel tank is empty, the vehicle cannot start or drive in LPG mode only.

Operation using LPG/petrol bi-fuel requires the presence of petrol (for starting, high acceleration, cold temperatures, etc.).

If the orange  warning light appears on the instrument panel accompanied by a beep, fill the tank with at least 1.76 gal (8 litres) of fuel.



For more information on LPG versions → 31.



Do not park the vehicle or run the engine in locations where combustible substances or materials such as grass or leaves can come into contact with the hot exhaust system.



Never switch off the ignition before the vehicle has stopped completely. Once the engine has stopped, the brake servo, power-assisted steering and the passive safety devices such as the airbags and pretensioners will no longer operate.

STARTING, STOPPING THE ENGINE



Driver's responsibility when parking or stopping the vehicle

Never leave an animal, child or adult who is not self-sufficient alone in your vehicle, even for a short time. They may pose a risk to themselves or to others by starting the engine, activating equipment such as the electric windows or locking the doors.

Also, in hot and/or sunny weather, please remember that the temperature inside the passenger compartment increases very quickly.

RISK OF DEATH OR SERIOUS INJURY.

Hybrid version



To switch on the ignition:

- shift the gear lever to **P** position;
- press the brake pedal;
- turn the key to the "Start" position **C** **without accelerating**;
- release the key as soon as the **READY** message appears on the instrument panel, accompanied by a beep.

The message disappears when the vehicle speed is above approximately 3 mph (5 km/h).

Stopping the Hybrid system

With the vehicle stopped, turn the key to the "Stop" position **A**. The ignition is

switched off and the **READY** message disappears from the instrument panel.



Before leaving the vehicle, check that the ignition has been switched off.

Ignition-starter switch on a vehicle with card



The card must be in the detection zone **1**.

To start:

- on a vehicle with an automatic gear-box, set the lever to **P** or **N** position,

STARTING, STOPPING THE ENGINE

press the brake pedal and press button **2**. On Hybrid vehicles, the READY message illuminates on the instrument panel along with a sound signal. The message disappears when the vehicle speed is above approximately 3 mph (5 km/h) km/h;



– on vehicles with a manual gearbox, press the brake pedal or clutch and press button **2**. If a gear is engaged, the vehicle may only be started by depressing the clutch pedal.

Special features

– If any of the starting conditions is not met, the "Press Brake + START" or "Press Clutch + Start" or "Select Gearbox Position "P"" message is displayed on the instrument panel;

– in some cases, it will be necessary to move the steering wheel whilst pressing the start button **2** to help unlock the steering column: in this case the "Turn Steering Wheel + START" message will warn you.

LPG version

The engine is always started using petrol.



While the fuel tank is empty, the vehicle cannot start or drive in LPG mode only.

Operation using LPG/petrol bi-fuel requires the presence of petrol (for starting, high acceleration, cold temperatures, etc.).



If the orange warning light appears on the instrument panel accompanied by a beep, fill the tank with at least 1.76 gal (8 litres) of fuel.



For more information on LPG versions ➔ **31**.

"Hands-free" starting with the luggage compartment open

In this case, the card must not be located in the luggage compartment.



Driver's responsibility when parking or stopping the vehicle

Never leave an animal, child or adult who is not self-sufficient alone in your vehicle, even for a short time.

They may pose a risk to themselves or to others by starting the engine, activating equipment such as the electric windows or locking the doors.

Also, in hot and/or sunny weather, please remember that the temperature inside the passenger compartment increases very quickly.

RISK OF DEATH OR SERIOUS INJURY.

Accessories function

(switching on the ignition)

STARTING, STOPPING THE ENGINE



Once you have gained access to your vehicle, you may use some of its functions (radio, navigation, wipers, etc.).

To use the other functions, with the card in the passenger compartment, press the button **2** without pressing the pedals.

Operating faults



In certain cases, the hands-free card may not work:

- when the card battery is drained, flat battery, etc.
- the card is near to appliances operating on the same frequency (screen, mobile phone, video game device, etc.);
- the vehicle is located in a high electromagnetic radiation zone.

The "Place card on zone + START" message appears on the instrument panel.

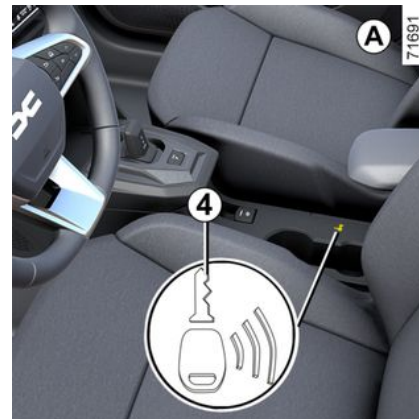

Press the brake or clutch pedal, then place the card **3** (**A** or **B**) on the symbol **4** (**A** or **B**). Press the button **2** to start the vehicle. The message goes out.

Special case of hybrid vehicles

With the vehicle stationary and in electric operating mode, the "Active engine Switch off" message appears on the instrument panel accompanied by a beep if:

- the driver's seatbelt is not fastened;
- the bonnet is open;
- the driver's door is open.

STARTING, STOPPING THE ENGINE



Conditions for stopping the engine



The vehicle must be stationary, with the lever positioned to **P** for vehicles with an automatic gearbox.

On Hybrid vehicles, the **READY** message is displayed on the instrument panel.

With the card in the vehicle, press the button **2**: the engine is switched off.

On Hybrid vehicles, the **READY** message disappears from the instrument panel.

The steering column is locked when the driver's door is opened or the vehicle is locked.

If the card is no longer in the passenger compartment or if the card's bat-

tery is flat, when the vehicle is stationary and you try to switch the engine off, the "Keycard absent : press/hold START" message appears on the instrument panel: press the button **2** for at least three seconds. If the card is no longer in the passenger compartment, make sure you can retrieve it before pressing and holding the button: without the card, you will not be able to start the vehicle.

With the engine switched off, any accessories being used (radio, etc.) will continue to function for approximately 10 minutes.

When the driver's door is opened, the accessories switch off.



Never switch off the ignition until the vehicle is stationary. Once the engine has stopped, the brake servo, power-assisted steering, etc., and the passive safety devices such as the airbags and pretensioners will no longer operate.

STARTING, STOPPING THE ENGINE



In order to preserve the 12 V battery, the engine unit will switch off automatically after approximately 15 minutes of the vehicle remaining stationary, as long as the driver's seat belt has not been fastened and the engine has not already been stopped manually using the **2** button. If necessary, you can restart the engine by pressing the button **2** once.



Do not park the vehicle or run the engine in locations where combustible substances or materials such as grass or leaves can come into contact with a hot exhaust system.



When you leave your vehicle, especially if you have your card with you, check that the engine is completely switched off.

Stop and Start function

This system enables a reduced fuel consumption and lower greenhouse gas emissions. The system is activated automatically when the vehicle is started. While driving, the system stops the engine (standby) when the vehicle is at a standstill (traffic jam, traffic lights, etc).

Conditions for engine standby

The vehicle has set off from where it was parked;

For vehicles equipped with automatic gearboxes:

- the gearbox is set to **D**, **L** position (depending on the vehicle) or **N** position;
- and
- the brake pedal is pressed (sufficiently hard);

Depending on the vehicle, if the  warning light flashes and the "Press

brake pedal" message appears on the instrument panel, this indicates that the brake pedal is not sufficiently pressed;

and

- the accelerator pedal is not pressed;
- and
- the speed is zero for around 1 second.

The engine remains on standby if position **P** is selected, or if position **N** is selected with the handbrake engaged and the brake pedal released.

For vehicles equipped with manual gearboxes:

- the gearbox is in neutral;

If the  warning light flashes and the "Shift to Neutral" message appears on the instrument panel, this indicates that you need to shift the gear lever to Neutral;

and

- the clutch pedal is released;
- and
- the vehicle speed is less than approximately 3 mph (5 km/h).

For all vehicles:

STARTING, STOPPING THE ENGINE

Warning light  on the instrument panel is lit when the engine is on standby.

The vehicle equipment remains operational while the engine is stopped.

When the engine switches to standby, the steering assistance may no longer be operational.

In this case it becomes operational again when the engine is no longer on standby or the speed exceeds approximately 1 mph (1 km/h) (downhill, slope, etc.).



If the engine is put in standby, the electronic parking brake (depending on the vehicle) is not applied automatically.



Keep your vehicle stationary when the engine is on standby (shown by the warning light  on the instrument panel).



→ 164.

Before leaving the vehicle, the engine must be switched off (and not put on standby) → 162,

Preventing the engine from standing by

In certain situations, such as negotiating a crossroads for instance, it is possible (with the system activated) to keep the engine on so as to be ready to move off quickly.

For vehicles equipped with automatic gearboxes:

Keep the vehicle stationary without pressing too hard on the brake pedal.

For vehicles equipped with manual gearboxes:

Keep the clutch pedal pressed right down.



To fill up with fuel, the engine must be switched off (and not only on standby in the case of vehicles equipped with the Stop and Startfunction): you must switch off the ignition → 162 → 164.
Fire hazard.

Conditions for coming out of engine standby

For vehicles equipped with automatic gearboxes:

– when the driver's door is opened;
or

– when the driver's seat belt is unfastened;

or

– the brake pedal is released and **D** or **L** position is engaged (depending on the vehicle);

or

– when the brake pedal is released, **N** position is engaged and the parking brake is released;

or

– when the brake pedal is pressed again, **P** position is engaged or **N** posi-

STARTING, STOPPING THE ENGINE

tion is engaged with the parking brake applied → 172 → 175;

or

– the **R** position is engaged;

or

– the accelerator pedal is depressed.

For vehicles equipped with manual gearboxes:

– when opening the driver's door, without any gear engaged and the clutch pedal released;

or

– when unfastening the driver's seat belt, without any gear engaged and the clutch pedal released;

or

– the gearbox is in neutral position and the clutch pedal is slightly pressed;

or

– the engine is in gear and the clutch pedal is pressed right down.

Special note: depending on the vehicle, if you switch off the ignition when the engine is on standby, the



warning light may be displayed for a few seconds on the instrument panel.



On vehicles equipped with a manual gearbox:

the restart may be interrupted if the clutch pedal is released too quickly while a gear is engaged.

Conditions preventing the standby of the engine

Certain conditions prevent the system from using the engine standby function, especially when:

- the driver's door is not closed;
- the driver's seat belt is not fastened;
- reverse gear is engaged;
- the bonnet is not locked;
- the outdoor temperature is too low or too high;
- the battery is not sufficiently charged;
- the difference between the vehicle interior temperature and the automatic climate control setpoint is too high;
- the Park Assist function is in operation;
- the altitude is too high;
- the slope is too steep for vehicles fitted with an automatic gearbox;
- the "Clear View" function is activated → 285;
- the engine temperature is too low;

– the emission control system is being regenerated;

– ...



Before carrying out any operation in the engine compartment, you must switch off the ignition

→ 162, → 164.

Special feature of the automatic engine re-start

Under certain conditions, the engine can restart on its own in order to guarantee your safety and comfort.

This may occur when:

- the outdoor temperature is too low or too high;
- the "Clear View" function is activated → 285;
- the battery is not sufficiently charged;
- the vehicle speed is above 3 mph (5 km/h) (downhill slope, etc.);
- the brake pedal is pressed repeatedly or there is a braking system requirement;
- ...

STARTING, STOPPING THE ENGINE



Before leaving the vehicle, the engine must be switched off (and not put on standby) → 162,

→ 164.

Deactivating, activating the function



Press the switch **1** to deactivate the function. The "Stop & Start deactivated" message appears on the instrument panel and the switch **1** indicator light is lit.

Pressing again will reactivate the system. The "Stop & Start Activated" message appears on the instrument panel

and the switch **1** indicator light goes out.

The system is automatically reactivated each time the vehicle is started using the start button → 164.

Operating faults

When the "Check Stop & Start" message appears on the instrument panel accompanied by the illumination of the switch **1** indicator light, this indicates that the system is deactivated.

Consult an approved Dealer.



Special note: when the engine is on standby, pressing the switch **1** once will automatically restart the engine.

GEAR CONTROL

Gearstick

Selecting reverse gear



(vehicle stationary)

Vehicle with a manual gearbox: shift the lever to Neutral, then shift the lever to Reverse.

Observe the grid marked on the knob **1** and lift the ring **2** up against the knob in order to engage reverse gear.

Vehicles fitted with an automatic gearbox → 172

The reversing light(s) will come on when reverse gear is selected (with the ignition on).

Automatic gearbox, electronic lever

Selector lever 1



R: reverse gear

N: neutral

D: forward gear

B: forward gear with increased regenerative braking (depending on the vehicle)

P: parking, button **2**

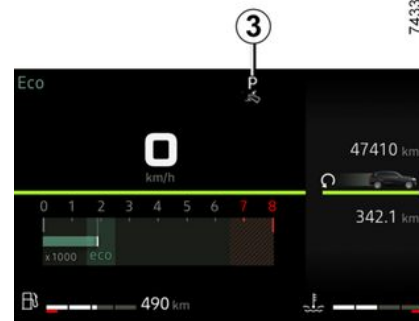

The **3** display on the instrument panel indicates the selector lever position engaged **1**.



Check that the **P** indicator or light on the instrument panel and the indicator light built into the button

2 are displayed before leaving the vehicle.

Risk of loss of immobilisation of the vehicle

Operation

GEAR CONTROL

With the vehicle stationary and the selector lever **1** in **P** position, start the vehicle.

On the Hybrid version, the READY message appears on the instrument panel.

With your foot on the brake pedal (the warning light **3** disappears from the display), exit **P** position and engage **D** position.

The lever must only be shifted to D, B or R position while the vehicle is stationary, your foot is on the brake and the accelerator pedal is released.



The READY warning light is displayed on the instrument panel to indicate that the Hybrid system is operating and ready for driving → 162, → 164.

Operation



Shift the selector lever **1** one or two notches forwards or backwards to engage the desired position (**R**, **N**, **D** or **B**), then release the lever and it will return to its stable position.

The position engaged lights up on the instrument panel.

If certain conditions prevent shifting from one position to another, the requested position flashes on the instrument panel.

To engage position P



With the vehicle stationary and the engine running or the ignition on, press the button **2** to engage **P** position. The warning light on button **2** appears in orange once the Park **P** position is engaged on the gearbox.

To disengage position P

With the vehicle stationary and the engine on, press the brake pedal and, move the **1** selector lever forwards or backwards according to the position desired. The **2** button warning light switches off.

If the brake pedal is not fully pressed, the "Press brake pedal" message and



warning light are displayed on the instrument panel.

GEAR CONTROL

Note:

– if the driver opens their door to leave the vehicle and **P** position has not been engaged, a beep sounds and the "P not engaged" message is displayed on the instrument panel;

– the warning light  appears each time the brake pedal must be pressed to change the automatic gear-box lever position.

To engage Neutral position (N)

With the vehicle stationary and the engine running, to engage **N** position, shift the selector lever **1** a notch forwards or backwards according to the gear engaged.

To engage forward gear (D position)

With the vehicle stationary and the engine running, shift the selector lever **1** two notches backwards to engage **D** position.

If one of the conditions is not applied, **D** flashes for around five seconds and the "Press brake pedal" message is displayed on the instrument panel for approximately 15 seconds.

In the majority of driving conditions, you will no longer have to use your gear lever: the gears change "automatically", at the right time, to a suitable

engine speed because the automated system takes the vehicle's load, road profile and the selected driving style into account.

Note: with the engine running and the vehicle travelling at between 0 and 5 mph (0 and 8 km/h), in **N** or **R** position, you will have to press the brake pedal in order to engage **D** position. This is useful during parking manoeuvres requiring a number of alternate forward and reverse movements.

Economical driving

When driving, always leave the lever in position **D**, keeping the accelerator pedal lightly depressed to ensure automatic gear changes at a lower engine speed.

Accelerating and overtaking

Depress the accelerator pedal briskly and fully (so that it goes beyond the kickdown point).

This will enable you to change down to the optimum gear within the engine range.

Driving in mode B

This mode enables driving with greater regenerative engine braking.

When releasing the accelerator pedal, the vehicle uses regenerative braking to slow down.

Thus the electric motor generates a higher electrical current which enables the traction battery to be recharged.

In **B** mode, the regenerative braking performance will be reduced if the battery is cold or fully charged.



The engine brake should under no circumstances be used as a substitute for the brake pedal.

To engage reverse gear (R position)

With the vehicle stationary and the engine running, shift the selector lever **1** two notches forwards to engage **R** position.

If the brake pedal is not pressed, a beep will sound, the **R** position display will flash for around five seconds on the grid shown on the instrument panel and the "Press brake pedal" message will be displayed for around 15 seconds.

Note: with the engine running and the vehicle moving at between approximately 0 and 5 mph (8 km/h), in **N** or **D** position you do not need to press the brake pedal to engage **R** position. This is useful during parking manoeuvres

GEAR CONTROL

requiring a number of alternate forward and reverse movements.

Gear change paddles 4 and 5



Depending on the vehicle, paddles **4** and **5** can be used to change gear when the selector lever **1** is in **D** position.

4: change to a lower gear.

5: change to a higher gear.

The **P**, **N** and **R** positions cannot be accessed using the paddles.

Driving in manual mode

When driving in **D** position, you can switch to manual driving mode using paddles **4** and **5** on the steering

wheel. Depending on the vehicle, two manual driving modes are available:

– the **"temporary" manual mode** can be used to force gear shifting by briefly pressing one of the two paddles. The driving mode **D** and the gear engaged appear on the instrument panel.

Note: the gearbox automatically returns to automatic mode **D** if the gear engaged is no longer optimal to vehicle performance or if no action has been taken on a paddle for a certain amount of time.

– **permanent manual mode is activated** by pressing and holding either of the paddles. The driving mode **M** and the gear engaged appear on the instrument panel.

Note: depending on the vehicle, the return to automatic mode is carried out by pressing and holding the right-hand paddle or by moving the one-touch lever **1** one or two notches backwards.

In all situations:

- to shift down through the gears, press the left-hand paddle;
- to move up through the gears, press the right-hand paddle.

Note: depending on the display, the

"+" and "-" or  and  indicat-

ors will suggest that you shift up or down a gear.

Automatic gearbox

Combustion version



Selector lever 1

P : park

R : reverse gear

N : neutral

D : forward gear

L : "Low" mode

The **4** display on the instrument panel indicates the gear lever position engaged **1**.

GEAR CONTROL



Note: press the **2** button to:

- exit position **P**;
- shift from **D**, **L** or **N** position to **R** or **P** position;
- shift from **D** position to **L** position.

Operation

With the selection lever **1** in **P** position, press the brake pedal then start the engine.

To move out of **P** position, you must press the brake pedal before pressing the unlocking button **2**.

With your foot on the brake pedal (warning light **3** disappears from the display), disengage **P**.

Only engage **D when the vehicle is stopped, with your foot on the brake and the accelerator pedal released.**

Driving in automatic mode

Set the lever **1** to **D** position.

In the majority of driving conditions, you will no longer have to use your gear lever: the gears change automatically, at the right time, to a suitable engine speed because the automated system takes the vehicle's load, road profile and the selected driving style into account.

Economical driving

When driving, always leave the lever in position **D**, keeping the accelerator pedal lightly depressed to ensure automatic gear changes at a lower engine speed.

Accelerating and overtaking

Depress the accelerator pedal briskly and fully (so that it goes beyond the kickdown point).

This will enable you to change down to the optimum gear within the engine range.

Special cases

In certain driving conditions (resulting in, for example, engine protection, activation of the electronic stability con-

trol (ESC), etc.), the automatic system may change the gear automatically.

Likewise, to prevent incorrect manoeuvres, a gear change may be refused by the automatic system: in this case the gear display flashes for a few seconds as a warning.



When facing uphill, to remain stopped, do not keep your foot on the accelerator.

Risk of overheating the automatic gearbox.



Check that the **P** warning light is displayed on the instrument panel before leaving the vehicle.

Risk of loss of immobilisation of the vehicle.

Special circumstances

If the road type or weather conditions (steep uphill slopes, steep descents, deep snow, sand or mud) make it difficult to stay in automatic mode, depending on the vehicle, it is advisable to switch to "Low" mode to enable

GEAR CONTROL

the vehicle to drive at low speed below 30 mph (50 km/h) on surfaces with low grip (snow, mud etc.), climbing a slope or engine braking during a hill descent. To do this, set the lever to position **L**.

Note: in "Low" mode, the variations in engine speed are continuous and the accelerations are more linear.

To avoid the engine stalling in very cold weather, wait a few seconds before disengaging **P** or **N** position and setting the lever to **D**, **R** or **L**.

Hybrid version



Selector lever **5**

R : reverse gear

N : neutral

D : forward gear

B : forward gear with increased regenerative braking

The **8** display on the instrument panel indicates the selector lever position engaged **5**.

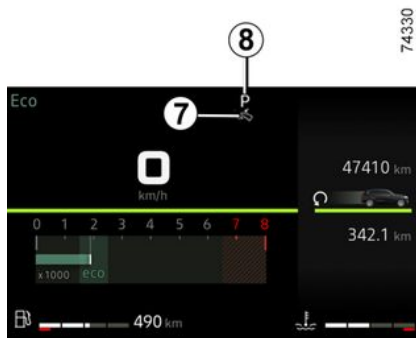

Note: press the **6** button to:

- exit position **P**;
- switch from position **D**, **B** or **N** to **R** or **P**;
- switch from position **D** to **B**.

Operation

With the vehicle stationary and the selector lever **5** in **P** position, start the

vehicle. The message **READY** appears on the instrument panel.

To move out of **P** position, you must press the brake pedal before pressing the unlocking button **6**.

With your foot on the brake pedal (warning light **7** disappears from the display), disengage **P**.

Only engage **D or **R** when the vehicle is stopped, with your foot on the brake and the accelerator pedal released.**

 The **READY** warning light is displayed on the instrument panel to indicate that the Hybrid system is operating and ready for driving → **162** → **164**.

Driving in automatic mode

Set the lever **1** to **D** position.

In the majority of driving conditions, you will no longer have to use your gear lever: the gears change automatically, at the right time, to a suitable engine speed because the automated system takes the vehicle's load, road profile and the selected driving style into account.

Economical driving

GEAR CONTROL

When driving, always leave the lever in position **D**, keeping the accelerator pedal lightly depressed to ensure automatic gear changes at a lower engine speed.

Accelerating and overtaking

Depress the accelerator pedal briskly and fully (so that it goes beyond the kickdown point).

This will enable you to change down to the optimum gear within the engine range.

Driving in mode B

This mode enables driving with greater regenerative engine braking. When releasing the accelerator pedal, the vehicle uses regenerative braking to slow down.

Thus the electric motor generates a higher electrical current which enables the traction battery to be recharged.

In **B** mode, the regenerative braking performance will be reduced if the battery is cold or fully charged.



The engine brake should under no circumstances be used as a substitute for the brake pedal.

Special cases

In certain driving conditions (resulting in, for example, engine protection, activation of the electronic stability control (ESC), etc.), the automatic system may change the gear automatically.

Special circumstances

To avoid the engine stalling in very cold weather, wait a few seconds before disengaging **P** or **N** position and setting the lever to **D**, **R** or **B**.



For safety reasons, do not switch off the ignition before the vehicle has come to a complete standstill.



Check that the **P** warning light is displayed on the instrument panel before leaving the vehicle.

Risk of loss of immobilisation of the vehicle.

**Combustion versions and hybrid
Parking the vehicle**

With the vehicle stationary, move the lever to **P** position while keeping your foot on the brake pedal: the gearbox is in neutral and the drive wheels are mechanically locked by the driveshaft.

Ensure that the electronic parking brake is engaged.



An impact to the underside of the vehicle while manoeuvring (e.g. striking a post, raised kerb or other street furniture) may result in damage to the vehicle (e.g. deformation of an axle).
To avoid any risk of accident, have your vehicle checked by an approved Dealer.

Maintenance period

Refer to the maintenance document for your vehicle or consult an approved Dealer to check whether the automatic gearbox requires scheduled maintenance.

If it does not need to be serviced, there is no need to top up the oil.

Operating faults

– **during driving**, if the "WARNING: Check Gearbox" message appears on

GEAR CONTROL

the instrument panel, this indicates a fault.

Contact an approved dealer as soon as possible;

- **when driving**, if the "WARNING: Gearbox Overheating" message appears on the instrument panel, stop as soon as possible to let the gearbox cool down and wait for the message to disappear;
- **breakdown recovery of a vehicle with an automatic gearbox → 348.**



For safety reasons, do not switch off the ignition before the vehicle has come to a complete standstill.



When setting off, if the lever is locked in position **P** when you press the brake pedal (e.g. battery fault), it is possible to manually release the lever to unblock the drive wheels. To do this, unclip the base of the gaiter and push in the push button **10** while simultaneously pressing the button **9** on the lever in order to unlock the lever and shift to **N** position.

Contact your approved Dealer as soon as possible;

PARKING BRAKE

Electronic parking brake

Assisted operation



Applying the electronic parking brake

With the vehicle stationary, the electronic parking brake can be used to immobilise the vehicle:

– by pressing the engine start/stop button 1 or by turning the ignition key 2 (key in "Stop and steering lock applied" position A);

or

– when the driver's seat belt is unfastened;

or

– when the driver's door is opened;



or

– on vehicles fitted with an automatic gearbox, when the P position is engaged.



Before leaving the vehicle, check that the electronic parking brake is fully applied. To indicate that the parking brake is applied, the warning light 3 on

switch 4 and the  warning light on the instrument panel light up until the doors are locked.

In all other cases, for example when the engine stalls or goes on standby due to the Stop and Start → 168 function, the electronic parking brake is not applied automatically. Manual mode must be used.

For certain country-specific model versions, the assisted brake application function is not activated. See the information on "Manual operation".

To confirm that the electronic parking brake is applied, the "Parking Brake

ON" message and the  warning light appear on the instrument panel and the indicator light 3 lights up on the switch 4.

After the engine is switched off, the 3 warning light goes out several minutes after the electronic parking brake has

been applied and the  warning light goes out when the vehicle is locked.

Note: in some situations (electronic parking brake failure, manual release of the parking brake, etc.), to indicate that the electronic parking brake is released a beep sounds and the "WARNING: Apply Parking Brake" message appears on the instrument panel:

– with the engine on: when the driver's door is opened;

PARKING BRAKE

– with the engine off (e.g. when the engine stalls): when a front door is opened.

In this case, pull and release the switch **4** to apply the electronic parking brake.



Assisted release of the parking brake

The release takes place as soon as the vehicle is started by acceleration or, on vehicles equipped with an automatic gearbox, when the ignition is switched on and **position P is shifted to R, N or D.**

Manual operation



You can apply the electronic parking brake manually.

Manually applying the electronic parking brake

Pull the switch **4**. Warning light **3** and warning light  on the instrument panel light up.



Manually releasing the electronic parking brake

To release the parking brake, press the **1** switch without pressing the pedals or turn the key **2** to the "On" position **B** to switch on the vehicle ignition. Press the brake pedal then press switch **4**: indicator light **3** on the instrument panel goes out.

switch and indicator light  displayed on the instrument panel go out.

PARKING BRAKE



Before leaving the vehicle, check that the electronic parking brake is fully applied. Warning light **3** on switch **4** and warning

light **(P)** on the instrument panel illuminate to show that the parking brake is applied but switch off when the doors are locked.

Brief stop



To apply the electronic parking brake manually (when stopping at a red light, stopping when the engine is running,

etc.): pull and release the switch **4**. The brake is released as soon as the vehicle is started up again.

Special cases

Parking on a slope

To park on a slope or while towing a trailer, for example, pull switch **4** for a few seconds to enable maximum braking.



Parking with the electronic parking brake released



Before deactivating the parking brake, make sure the vehicle is stable.

To park with the electronic parking brake released, the parking brake must be deactivated.

To do this:

- engage any gear or the P position: the drive wheels will be mechanically locked by the driveshaft;
- switch off the engine by pressing the engine start/stop button **1** or by turning the ignition key **2**;
- unfasten the driver's seat belt;
- open the driver's door;
- manually release the electronic parking brake (please see the paragraph on "Manually releasing the electronic parking brake"). Make sure the vehicle is stable;
- close the driver's door. If necessary, lock your vehicle.

Versions with an automatic gear-box

For safety reasons, automatic release is deactivated when the driver's door is

PARKING BRAKE

open or not shut properly and the engine is running (in order to prevent the vehicle from moving without the driver). The "Release Parking Brake" message appears on the instrument panel when the driver presses the accelerator pedal.



Never leave your vehicle without moving the selector lever to position **P** and switching off the engine. This is because when the vehicle is stationary with the engine running and a gear engaged, the vehicle may begin to move if you accelerate.

There is a risk of accidents.



If the "Electric System Failure" or "Check battery" or "WARNING: Braking System" message appears, you must immobilise the vehicle by selecting first gear (on a manual gearbox), engaging **P** position (automatic gearbox) or by pulling the switch **4** for approximately 10 seconds. If the conditions and the slope require it, chock the wheels of the vehicle.

Risk of loss of immobilisation of the vehicle.

Call an approved dealer.

comes on, along with the "WARNING: Braking System" message, a beep

and, in some cases, the  warning light.

This means that you must stop as soon as traffic conditions allow.



If no lights or sounds are apparent, this indicates a fault in the instrument panel. This indicates that it is essential to stop immediately (as soon as traffic conditions allow). Ensure that the vehicle is correctly immobilised and contact an approved Dealer.

Operating faults

– If there is a fault, the  warning light illuminates on the instrument panel accompanied by the "Check Parking Brake" message and, in some

cases, the  warning light.

Contact your approved Dealer straight away.

– If there is an electronic parking

brake fault, the  warning light

PARKING BRAKE

Handbrake



To release

Pull the lever **4** upwards slightly, press the button **3** and lower the lever to the floor.

The warning light  on the instrument panel will go out.

The red warning light will appear on the instrument panel accompanied with a beep if you are driving with an incorrectly released parking brake (at a speed over 6 mph (10 km/h)).

To apply:

Pull the lever **4** upwards and make sure the vehicle is immobilised.

The warning light  on the instrument panel will come on.



Make sure that the handbrake is properly released when driving (red indicator light off), otherwise overheating, or even damage, may occur.



When stationary and depending on the slope and/or vehicle load, it may be necessary to pull up the handbrake at least two extra notches and engage a gear (1st or reverse gear) for vehicles with a manual gearbox or position **P** for vehicles with an automatic gearbox.



An impact to the underside of the vehicle while manoeuvring (e.g. striking a post, raised kerb or other street furniture) may result in damage to the vehicle (e.g. deformation of an axle). To avoid any risk of accident, have your vehicle checked by an Approved Dealer.

SPECIAL FEATURES OF DIESEL VERSIONS

Diesel engine speed

When driving, to avoid damaging the engine, never let the engine speed exceed 4,500 rpm, regardless of which gear is engaged.

If the "Check Anti- Pollution System" message is displayed along with the



and  warning lights, consult an approved dealer immediately.

When driving, depending on the grade of fuel used, it is possible that white smoke may be emitted.

This is due to the exhaust particle filter being cleaned automatically, and does not affect the way the vehicle runs.

Running out of fuel

After the tank has been filled following a **complete draining of fuel**, the fuel system → 154 must be reprimed before starting the engine.

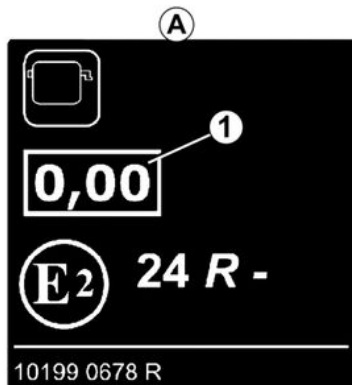

Engine smoke opacity label

You can find the information **1** on the label **A** affixed in the engine compartment or, depending on the vehicle, on the vehicle identification plate → 378.

1 Diesel exhaust emissions.

Precautions to be taken in winter

To avoid any faults in icy weather:

- ensure that the battery is always fully charged;
- always keep the diesel tank relatively full to avoid water vapour condensing in it and accumulating at the bottom of the tank.





Do not park the vehicle or run the engine in locations where combustible substances or materials such as grass or leaves can come into contact with the hot exhaust system.

Particle filter

The particle filter is used in the treatment of exhaust gases from diesel engines.

Depending on the vehicle, the warning

light  displayed on the instrument panel indicates that the filter is becoming clogged and requires cleaning.

To do this, when the  warning light is displayed, continue driving according to traffic conditions and observe the speed limit until the warning lights disappears. If possible, do not let the engine speed drop below 2000 rpm.

The warning light should go out after approximately 10 to 20 minutes → 124.

The display of the  on the instrument panel may be accompanied by an increase in engine speed and oper-

SPECIAL FEATURES OF DIESEL VERSIONS

ation of the cooling system in order to clean the particle filter.

Note: the warning light may reappear if the driving conditions are not fully met with regard to cleaning the filter. If the vehicle is stopped or if the engine speed drops below 2,000 rpm before the warning light goes out, the operation may need to be repeated.



To facilitate the particle filter regeneration, carry out a long driving phase (at least 20 minutes) on main roads every 124 miles (200 km).

If the filter becomes saturated, the



warning light and, depending

on the vehicle, the  warning light appears on the instrument panel accompanied by the "Check injection" message. In this case, please consult an Authorised Dealer.

If the **STOP** warning light and, de-

pending on the vehicle, the  warning light appear accompanied by the "WARNING: Engine Failure Risk"

message, stop the vehicle and contact an approved dealer.



For your own safety, the



warning light requires you to stop immediately, as soon as traffic conditions allow. Switch off the engine and do not restart it. Call an approved dealer.

SPECIAL FEATURES OF PETROL VERSIONS

The following operating conditions:

- driving for long periods when the low fuel level warning light is lit;
- using leaded petrol;
- using oil or fuel additives which are not approved by the manufacturer.

Or operating faults such as:

- a faulty ignition system, running out of fuel or disconnected spark plugs resulting in the engine misfiring or jerkiness while driving;
- loss of power,

as they may cause the catalytic converter to overheat and thus reduce its efficiency, **or damage it irreparably and cause heat damage to the vehicle.**

If you notice any of the above operating faults, have the necessary repairs carried out as soon as possible by an approved Dealer.

These faults may be avoided by regularly taking your vehicle to your approved Dealer at the intervals specified in your Maintenance Service Document.

Starting problems

To avoid damaging the catalytic converter or the starter, and to prevent premature wearing of the battery, **do not keep trying to start the engine**

(using the start button, or by pushing or towing the vehicle) without having identified and corrected the starting fault.

If the fault cannot be identified, do not keep trying to start the engine, but contact an approved Dealer.





Do not park the vehicle or run the engine in locations where combustible substances or materials such as grass or leaves can come into contact with the hot exhaust system.

Particle filter

The particle filter is used in the treatment of exhaust gases from petrol engines.

Depending on the vehicle, the warning

light  displayed on the instrument panel indicates that the filter is becoming clogged and requires cleaning.

To clean it, when the  warning light appears, and as traffic conditions and speed limits allow, drive at between about 31 mph (50 km/h) and

68 mph (110 km/h) until the light goes out.

After between approximately 5 and 20 minutes, the warning light should go out.

Note: the warning light may go out after 20 minutes if the driving conditions required to clean the filter are not fully met.

If the vehicle is stopped before the warning light disappears you will have to restart the process from the beginning.

If the filter becomes saturated, the



warning light and, depending

on the vehicle, the  warning light appears on the instrument panel accompanied by the "Check injection" message. In this case, please consult an Authorised Dealer.

If the **STOP** warning light and, de-

pending on the vehicle, the  warning light appear accompanied by the "WARNING: Engine Failure Risk" message, stop the vehicle and contact an approved dealer.

SPECIAL FEATURES OF PETROL VERSIONS



For your own safety, the

STOP

warning light requires you to stop immediately, as soon as traffic conditions allow. Switch off the engine and do not restart it. Call an approved dealer.

3

ENVIRONMENT

Your vehicle has been designed with respect for the **environment** in mind for its entire service life: during its production, usage and at the end of its service life.

Manufacture

Your vehicle has been manufactured at a factory which complies with a policy to reduce the environmental impact on the surrounding areas (reduction of water and energy consumption, visual and noise pollution, atmospheric emissions and waste water; sorting and re-using waste).

Emissions

Your vehicle has been designed to emit fewer greenhouse gases (CO₂) while in use, and therefore to consume less fuel (e.g. 225 g/mile (140 g/km), equivalent to 1.16 gal/62 miles (5.3 l/100 km) for a diesel vehicle).

Our vehicles are also equipped with an emission control system including a catalytic converter, an oxygen sensor and a petrol vapour filter (the latter prevents vapour from the fuel tank being released into the open air), etc.

For certain diesel vehicles, this system also has a particle filter to reduce the volume of soot particles emitted.

Please make your own contribution towards protecting the environment too.

- Parts and vehicles at the end of their life must not be thrown away. They must be handed to a legal entity that complies with environmental standards.
- Worn parts and components that are replaced during routine vehicle maintenance, such as tyres or oil (tanks emptied or filled) must be disposed of at dedicated collection points.
- Worn **electrical** and **electronic** components that are replaced (such as batteries) must not be thrown away as rubbish. Take them to an approved Dealer or consult your local authority for information on appropriate recycling facilities.



- To optimise the recycling of your vehicle at the end of its life, you can contact an authorised dealer or visit the manufacturer's website to be directed to collection points that guarantee respect for the environment complying with local laws.
- At the end of the vehicle's service life, it should be sent to approved centres to ensure that it is recycled.
- In all cases, comply with local legislation.

Recycling

Your vehicle is at least 85% recyclable and at least 95% recoverable.

To achieve these objectives, many of the vehicle components have been de-

ENVIRONMENT

signed to enable them to be recycled. The materials and structures have been carefully designed to:

- allow these components to be easily removed and reprocessed by specialist companies;
- promote a circular economy (re-use, recycling, recovery, etc.)

This is particularly true for electrified vehicle batteries.

Furthermore, in order to preserve raw material resources, your vehicle incorporates numerous parts made from recycled plastics or renewable materials (vegetable or animal-derived materials such as cotton or wool).

MAINTENANCE AND ANTIPOLLUTION ADVICE

Your vehicle complies with criteria for recycling and recovering vehicles at the end of their service life, which entered into force in 2015.

Some of the parts on your vehicle have been designed to be recycled later.

These parts are easily removable in order to be collected and reprocessed in recycling networks.

Furthermore, by virtue of its design, moderate fuel consumption and initial settings, your vehicle also conforms to current anti-pollution regulations. The manufacturer is actively striving to reduce pollutant exhaust gas emissions and to save energy. But the fuel consumption of your vehicle and the level of pollutant exhaust gas emissions are also your responsibility. Ensure that it is maintained and used correctly.

Maintenance

It is important to remember that failure to respect antipollution regulations could lead to legal action being taken against the vehicle owner.

In addition, replacing engine, fuel supply system and exhaust components with parts other than those originally recommended by the manufacturer may alter your vehicle so that it no

longer complies with antipollution regulations.

Have your vehicle adjusted and checked by an approved dealer, in accordance with the instructions given in your maintenance schedule: they will have all the equipment necessary for ensuring that your vehicle is maintained to its original standard.

Engine adjustments

- **Spark plugs:** for optimum fuel economy, efficiency and performance, the specifications which have been laid down by our Design Department must be strictly applied.

If the spark plugs have to be changed, use the make, type and gap specified for your vehicle's engine. Contact an authorised dealer for this.

- **Air filter, fuel filter:** a choked element hinders performance. It must be replaced.
- **Ignition and idle speed:** no adjustment is needed.

Exhaust gas monitoring system

The exhaust gas monitoring system will detect any operating faults in the vehicle's emission control system.

If this system malfunctions, toxic substances can be released into the at-

mosphere or mechanical damage may occur.



This indicator light on the instrument panel indicates possible faults in the system:

This lights up when the ignition is switched on and goes out when the engine is started.

- If it lights up continuously, contact an approved Dealer as soon as possible;
- If it flashes, reduce the engine speed until the light stops flashing. Contact your approved Dealer as soon as possible;



Particle filter system warning light → 187 → 185.



Warning light for reagent level and faults in the exhaust gas reduction system → 157.

DRIVING ADVICE, ECO-DRIVING

Fuel consumption is accredited in accordance with a standard regulatory method. Identical for all manufacturers, this enables vehicles to be compared with one another. Consumption in real time depends on vehicle usage conditions, the equipment fitted and the user's driving style. To optimise fuel consumption, please refer to the following advice.

Depending on the vehicle, you have different functions to help you reduce your fuel consumption.

On the instrument panel:

- the rev counter;
- the gear change indicator;
- the driving style indicator;
- ECO mode;
- the Stop and Start → **168** function;
- the power meter;
- the navigation system.

On the multimedia screen (for more information, see the multimedia system user manual):

- data relating to your energy consumption;
- an energy consumption graph;
- scores based on your driving style;
- ECO driving advice;
- the journey record and eco-driving advice via the multimedia screen;
- an ECO driving mode.

On the instrument panel **A** or **B**

Depending on the vehicle, the information display can be organised and customised based on the instrument panel customisation style selected from the multimedia screen.

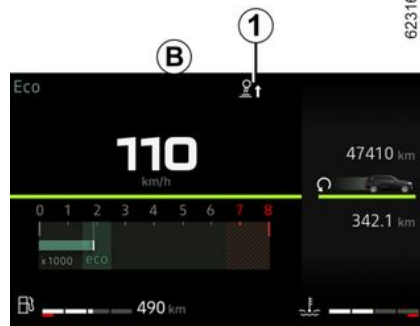

Gear change indicator **1**

Depending on the vehicle, to obtain optimum consumption levels, a warning light on the instrument panel lets you know the best time to move up or down a gear:

 shift up a gear;

 downshift a gear.

If you regularly follow this indicator, you will reduce your vehicle's fuel consumption.

DRIVING ADVICE, ECO-DRIVING

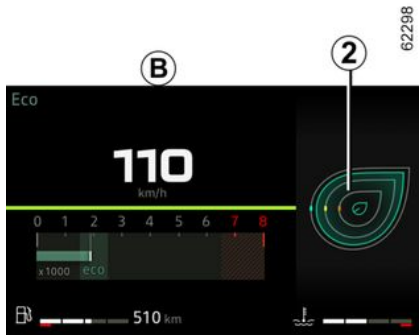

Driving style indicator 2

After activation, you will be informed about the driving style adopted in real time. You will be notified by indicator 2.

The more petals displayed on the indicator 2, the more your driving is flexible and economical.

If you regularly monitor this indicator, you will reduce your vehicle's fuel consumption.

Please refer to the multimedia instructions for further information.

On the multimedia screen



Journey record

Once the engine is switched off, you will see "Journey record" displayed on the multimedia screen 3, enabling you to view information on your last journey.

This indicates:

- general score;
- score evolution;
- distance without fuel consumption.

An overall rating from 0 to 100 is displayed to let you assess your eco driving performance.

The higher the rating, the lower the fuel consumption.

Eco advice is given to help improve your performance.

With your favourite journeys saved, you can compare your performance between trips and the performance of other vehicle users.

Please refer to the multimedia instructions for further information.

ECO mode



(depending on the vehicle)

ECO mode is a function which optimises fuel consumption. It affects the vehicle behaviour (acceleration, gear shifting, cruise control, deceleration, etc.).

DRIVING ADVICE, ECO-DRIVING

Limiting acceleration enables low fuel consumption in urban and surrounding areas.

Activating the function

Press the switch 4.

The 5 **ECO** warning light comes on on the instrument panel to confirm activation.

While driving, it is possible to exit the ECO mode temporarily in order to improve engine performance.

To do this, press the accelerator pedal firmly and fully.

ECO mode is reactivated when you take pressure off the accelerator pedal.

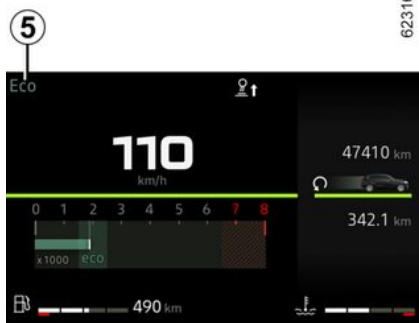

Deactivating the function

Press the switch 4.

Warning light 5 **ECO** goes out on the instrument panel to confirm deactivation.

Power meter

(Hybrid version)

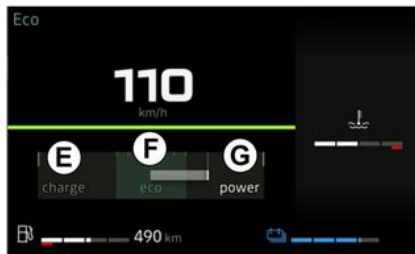

The charge meter gives you a real-time view of the energy consumed or recovered when the vehicle is moving.

"Energy recovery" E usage zone

When driving, if you lift your foot off the accelerator pedal or press the brake pedal, the motor generates electrical current during deceleration, and this energy is used to slow down the

vehicle and recharge the traction battery → 172.

"Optimal" F usage zone

Indicates economical driving, balanced between recovery and energy expenditure.

"Energy consumption" G usage zone

In all-electric or E-tech full hybrid mode, the traction battery and/or the combustion engine supply the energy required to move the vehicle.

Navigation system

Use the information available on your navigation system (traffic information etc.) to simplify your journey.

 The presence and display of this information depends on the type of ambient setting selected.

DRIVING ADVICE, ECO-DRIVING

Maintaining the traction battery charge level: « E-Save »



To activate the function, press the **6** switch.

The warning light on top of the switch **7** comes on to confirm activation.

This mode enables you to maintain a sufficient charge level in the traction battery in anticipation of a mountain road or a long motorway slope.

To deactivate the function, press the switch **6**.

The **7** indicator light goes out to confirm deactivation.

Driving advice and Eco driving



Behaviour

– Drive carefully until the engine reaches its normal operating temperature, rather than let it warm up while the vehicle is stationary.

– High speeds significantly affect the vehicle's fuel consumption.

Examples (at a steady speed):

– reducing the speed from approximately 80 mph (130 km/h) to 68 mph (110 km/h) saves up to around 20% of fuel;

– reducing the speed from approximately 56 mph (90 km/h) to 50 mph (80 km/h) saves up to around 10% of fuel.

– Dynamic driving with a lot of frequent acceleration and braking is expensive on fuel in comparison to the time saved.

– Do not overrev the engine in the intermediate gears. Always use the highest gear possible without labouring the engine.

– Avoid sudden acceleration.

– Brake as little as possible. If you anticipate an obstacle or bend in advance, you may then simply release the accelerator pedal.

– Do not try to maintain the same speed up a hill, accelerate no more than you would on level ground. Keep your foot in the same position on the accelerator pedal.

– Double declutching and accelerating before switching off the engine are unnecessary in modern vehicles.

– Bad weather, flooded roads:



Do not drive through water if it is higher than the lower edge of the wheel rim.

Heating levels

It is normal to notice an increase in the vehicle's fuel consumption when using the heating (particularly when the outside temperature drops below zero) or air conditioning.

DRIVING ADVICE, ECO-DRIVING



Driver obstruction

On the driver's side, only use mats suitable for the vehicle, attached with the pre-fitted components, and check the fitting regularly. Do not lay one mat on top of another. **There is a risk of wedging the pedals.**

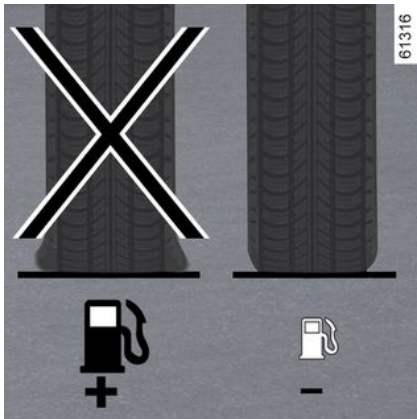

Tyres

- An underinflated tyre increases fuel consumption.
- To optimise fuel consumption, set the highest speed tyre pressure or the

recommended pressure indicated on the edge of the driver's door ➔ 337.

- The use of non-recommended tyres can increase fuel consumption.



Advice on use

- Favour the ECO mode.
- Electricity is fuel – switch off all the electrical components when they are not genuinely needed. **However** (safety first), keep your lights on when the visibility is bad ("see and be seen").
- Use the air vents. Driving with the windows open at 62 mph (100 km/h) will increase fuel consumption by 4%.
- Never fill the fuel tank right to the brim to avoid overflow.

- **On vehicles equipped with non-automatic air conditioning**, switch off the air conditioning when it is not required.

Advice for reducing consumption and helping to preserve the environment:

- If the vehicle has been parked in the sun, open the doors for a few moments to let the hot air escape before starting the engine.
- Do not leave an empty roof rack fitted to the vehicle.
- It is better to fit a trailer for bulky objects.
- When towing a caravan, fit a wind deflector and adjust it carefully.
- Avoid using the vehicle for "door-to-door" calls (short journeys with long waits in between) because in such conditions the engine never reaches its optimal operating temperature.

TYRE PRESSURE MONITORING SYSTEM

If the vehicle is equipped with the function, this system monitors the tyre pressure.

Operating principle

Each wheel (except for the emergency spare wheel) has a sensor in the inflation valve which periodically measures the tyre pressure.



The system displays the current pressures on the instrument panel **1** and alerts the driver in the event of insufficient pressure.

Resetting the standard level for the tyre pressures

This should be performed:

- when the standard tyre pressure needs to be changed to adapt to usage conditions (empty, carrying a load, motorway driving, etc.);
- after swapping a wheel (however, this practice is not recommended);
- after changing a wheel.

It should always be done after checking the tyre pressure of all four tyres when cold.

Tyre pressures must correspond to the current usage of the vehicle (empty, carrying a load, motorway driving, etc.).

i If the wheels are swapped, the system must be reinitialised. Consult an approved Dealer.

i If the vehicle is equipped with a navigation system, the resetting procedure may also be carried out using the multimedia screen: please see the equipment instructions.



Resetting procedure

Ignition on, **vehicle stopped**:

- repeatedly tap switch **5** as many times as necessary to reach the

"Vehicle" tab 

- briefly press switch **2** or **3** repeatedly to reach the "Tyre Pressure" page;
- press and hold (around 3 seconds) on the control **4** to launch the reset. The tyre warning light flashes and the "Learning Tyre Pressures" then the "Tyre detection in progress" messages appear to indicate that the reset request for the tyre pressure reference value has been registered.

TYRE PRESSURE MONITORING SYSTEM

Reset can take several minutes of driving.

If the resetting is followed by short trips, the message "Tyre detection in progress" may remain displayed after successive restarts.

Note: the tyre pressure reference value cannot be less than that recommended and indicated on the door frame.







For your safety, the warning light **STOP** requires you to stop immediately as soon as traffic conditions allow.

TYRE PRESSURE MONITORING SYSTEM

Message display

The table below shows the possible messages related to the tyre resetting procedure.

Steps	Displays (depending on the vehicle)	Readings
1		With the ignition on and the vehicle stationary, start resetting the pressure of all four tyres by pressing and holding the 4 OK switch.
2		The "---" symbols in front of each wheel will flash to indicate that the system has registered the tyre pressure reset for all four wheels.
3		The "---" symbols in front of each wheel will remain lit. This system resets the tyre pressure of all four tyres. You can now drive. The message may remain displayed during short journeys. Note: during the reset, tyre pressure monitoring remains in operation.
4		The pressure value of the four tyres is displayed: the resetting procedure is complete and successful.

TYRE PRESSURE MONITORING SYSTEM

Readjustment of tyre pressures

The pressure of the four tyres must be set when cold (refer to the label located on the edge of the driver's door). If the tyre pressures cannot be checked when the tyres are cold, the recommended pressures should be increased by **0.2 to 0.3 bar (3 PSI)**.

Never deflate a hot tyre.

Emergency spare wheel

If the vehicle is equipped with an emergency spare wheel, it will not have a sensor.



This function is an additional driving aid.

The function does not take the place of the

driver. It cannot, therefore, under any circumstances replace the vigilance or the responsibility of the driver. Check the tyre pressures, including the emergency spare wheel, once a month.

Replacing wheels/tyres

This system requires specific equipment (wheels, tyres, wheel rims, etc.) → **335**.

Contact an approved dealer to replace the tyres and to find out about accessories compatible with the system that are available from the brand's network: using any other accessory could affect the correct operation of the system.



Changing a wheel

The system may take several minutes depending on use for the new

wheel positions and pressures to be recognised; check the tyre pressures after all operations.

Tyre repair product and inflation kit

Because the valves are specially designed, only use equipment approved by the approved network. Please see the paragraph on → **338**.

Tyre pressure faults

The table lists the warning messages which appear on the instrument panel

1 when the system detects a tyre pressure fault.











The information on the instrument panel signals any potential tyre pressure faults (e.g. deflated or punctured tyre). For your own safety,

the **STOP** warning light requires you to stop immediately, as soon as traffic conditions allow.

TYRE PRESSURE MONITORING SYSTEM

Possible tyre pressure faults

Indicator lights	Messages (depending on the vehicle)	Displays (depending on the vehicle)	Readings
 comes on (not flashing).	Adjust Tyre Pressure		<p>The wheel and associated pressure value are displayed in yellow.</p> <p>This indicates that tyre under-inflation has been detected. Check and adjust the pressure of the four tyres then reset the system.</p>
 + STOP comes on (not flashing).	Puncture		<p>The wheel and associated pressure value are displayed in red.</p> <p>This indicates that the tyre concerned is punctured or severely underinflated. Adjust the pressure of the four tyres while cold and reset the system if the tyre is deflated. Replace the tyre (or have it replaced) if it is punctured.</p>
 flashes, then stays on, along with the warning light 	Check Tyre Pressure Sensors		<p>A wheel is no longer displayed.</p> <p>This indicates that at least one wheel is not fitted with a sensor (e.g. emergency spare wheel) or that the sensor is faulty. Consult an approved Dealer.</p>
 comes on (not flashing).	Failure to detect tyres		<p>This indicates that the system has not been able to determine the pressure of each tyre. This may be caused by the use of a sensor not recommended by an approved dealer. The tyre pressure sensor monitoring system remains in operation.</p>

TYRE PRESSURE LOSS WARNING

61319

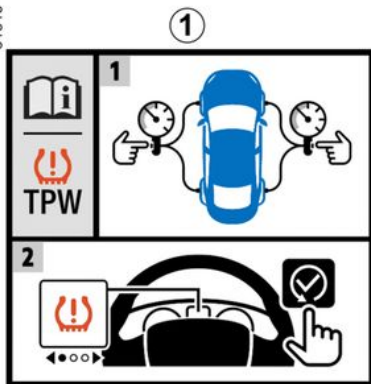

3

When fitted to the vehicle, this system notifies the driver if one or more tyres lose pressure.

The system can be identified by the **1** label in the vehicle.



Operating principle

This system detects a loss of pressure in one of the tyres by measuring the wheel speed while driving.

Warning light **2** comes on steady to alert the driver in the event of insufficient pressure (deflated wheel, punctured tyre, etc.).



62109



71696

TYRE PRESSURE LOSS WARNING



This function is an additional driving aid.

The function does not take the place of the driver. It cannot, therefore, under any circumstances replace the vigilance or the responsibility of the driver. Check the tyre pressures, including the emergency spare wheel, once a month.

Operating conditions

In order to provide a reliable warning in the event of significant pressure loss, the system must be reset with a tyre pressure equal to one of those shown on the tyre pressure label (reference values) → 337.

Resetting should always be carried out after checking the tyre pressure of all four tyres when cold.

In the following situations, the system risks coming into action late or not functioning correctly:

- system not reset after reinflation or any operation on the wheels;
- incorrectly reset system: tyre pressures different from the recommended pressures.



The tyre pressure must be checked before starting the resetting procedure.

The system will not issue a warning if the pressure does not correspond to the recommended pressure.

- significant change in load or distribution of load on one side of the vehicle;
- sporty driving with strong acceleration;
- driving on snowy or slippery surface;
- driving with snow chains;
- fitting a single new tyre;
- use of tyres not approved by the network.



A sudden loss of pressure in a tyre (burst tyre, etc.) may not be immediately detected by the system.

Procedure for resetting the standard levels for the tyre pressures

This should be performed:

- after each re-inflation or resetting of tyre pressure;

- after changing a wheel;
- after swapping a wheel (however, this practice is not recommended).

Tyre pressures must correspond to the current usage of the vehicle (empty, carrying a load, motorway driving, etc.).

Respect the tyre pressures (including the emergency spare wheel). Check them at least once a month and before a long journey (refer to the label on the edge of the driver's door → 337).

Vehicles not fitted with a multimedia screen



Ignition on, vehicle stopped:

TYRE PRESSURE LOSS WARNING

– briefly press on **6** as many times as

necessary to reach the "Vehicle"  tab.

– briefly press switch **3** or **4** repeatedly to reach the "Tyre pressure init. long press" page;

– press and hold switch **5 OK** to launch the reset.

Hold down the **5** switch until the "Operation completed" message appears. You can now drive.

Please refer to the multimedia instructions for further information.

3

Vehicles fitted with a multimedia screen **8**



The resetting procedure must be carried out while the **vehicle is stationary** and the ignition is switched on.

TYRE PRESSURE LOSS WARNING

Possible messages

The table below shows the possible messages related to the tyre resetting procedure.

Steps	Messages	Readings
-	Tyre pressure init. at stop	The message is displayed during driving. If you want to reset the pressure of the four tyres, stop the vehicle.
1	Tyre pressure init. long press	To reset the pressure of the four tyres, with the vehicle stopped, press and hold the 5 OK switch to launch resetting until the "If pressure OK [hold on]" message is displayed.
2	If pressure OK [hold on]	The message flashes. This is a reminder that the pressure must be adjusted to the reference values recommended on the tyre inflation pressure label ➔ 337 . Press and hold switch 5 OK to confirm the reset request until the "Operation completed" message appears.
3	Operation completed	The resetting procedure has been completed successfully. You can now drive.

TYRE PRESSURE LOSS WARNING

Readjustment of tyre pressures

The pressure of the four tyres must be set when cold (refer to the label located on the edge of the driver's door).

If tyre pressures cannot be checked when the tyres are **cold**, the recommended pressures should be increased by **0.2 to 0.3 bar (3 PSI)**.

Never deflate a hot tyre.

After each reinflation or readjustment of the tyre pressure, launch the resetting of the tyre pressure reference value.

Replacing wheels/tyres

Only use equipment approved by the brand network, otherwise the system risks late activation or incorrect operation → **335**.

After each change of wheel/tyre, readjust the tyre pressure and launch the reset of the tyre pressure reference value.

Emergency spare wheel

If fitted on the vehicle, readjust the tyre pressure and launch the resetting of the tyre pressure reference value.

Tyre repair product and inflation kit

Only use equipment approved by the brand network, otherwise the system risks late activation or incorrect operation → **338**. After using the tyre inflation kit, readjust the tyre pressure and launch the resetting of the tyre pressure reference value.

Tyre pressure faults







The table lists the warning messages which appear on the instrument panel **9** when the system detects a tyre pressure fault.

TYRE PRESSURE LOSS WARNING

Possible messages

The information on the instrument panel signals any potential tyre pressure faults (e.g. deflated or punctured tyre).

Indicator lights	Messages	Readings
 comes on (not flashing).	Inflate tyres and init.	This indicates that tyre under-inflation or puncture has been detected. Check and adjust the pressure of the four tyres when cold and reset the system.
 flashes, then stays on.	Check tyre press and init.	This indicates that the reset has been unsuccessful. Check and readjust the tyre pressure before re-launching the resetting procedure.
 flashes, then stays on, along with the warning light 	Check TPW	This indicates a fault in the system. Consult an approved Dealer.
 flashes, then stays on.	TPW not available	This indicates that an emergency spare wheel different in size to the other four wheels has been fitted to the vehicle. The system remains unavailable until a wheel identical in size to the other wheels has been fitted and the resetting procedure has been carried out.

DRIVER CORRECTION DEVICES AND AIDS

Depending on the vehicle, they may include:

- the anti-lock braking system (ABS);
- of the electronic stability program (ESC) with understeer control and traction control;
- emergency brake assist;
- hill start assistance;
- the regenerative braking system
- traction control - "Extended grip".



These functions are an additional aid in the event of critical driving conditions, enabling the vehicle behaviour to be adapted to suit the driving conditions. The functions do not take the place of the driver. **They do not increase the vehicle's limits and should not encourage you to drive more quickly.** Therefore, they can under no circumstances replace the vigilance or responsibility of the driver when manoeuvring the vehicle (the driver must always be ready for sudden incidents which may occur when driving).

Anti-lock braking system (ABS)

Under heavy braking, the ABS prevents the wheels from locking, allowing the stopping distance to be managed and keeping control of the vehicle.

Under these circumstances, the vehicle can be steered to avoid an obstacle whilst braking. In addition, this system can increase stopping distances, particularly on roads with low surface grip (wet ground etc.).



You will feel a pulsation through the brake pedal each time the system is activated. The ABS does not in any way improve the vehicle's "physical" performance relating to the road surface and roadholding. It is still **essential** to follow the rules of good driving practice (such as driving at a safe distance from the vehicle in front etc.).



In an emergency, apply **firm and continuous pressure** to the brake pedal.

There is no need to pump it repeatedly. The ABS will modulate the force applied in the braking system.

Operating faults:

–  and  lit up on the instrument panel accompanied by the "ABS", "WARNING: Check Braking System" and "ESC" messages: this indicates that the ABS, the ESC and the Emergency Brake Assist functions are deactivated. **Braking is still provided;**

– , ,  and

STOP are displayed on the instrument panel "WARNING: Braking Sys-

DRIVER CORRECTION DEVICES AND AIDS

tem": **this indicates a failure with the braking system.**

In both cases, please contact an Approved Dealer.



For your own safety, the



warning light requires you to stop immediately, as soon as traffic conditions allow. Switch off the engine and do not restart it. Call an approved Dealer.



Your braking systems are partially operational.

However, **it is dangerous to brake suddenly** and it is essential to stop immediately, as soon as traffic conditions allow. Call an approved Dealer.

Emergency brake assist

This system supplements the ABS and helps reduce vehicle stopping distances.

Operating principle

The system is for detecting an emergency braking situation. In this case, the braking assistance immediately develops maximum power and may trigger ABS regulation.

ABS braking is maintained as long as the brake pedal is applied.

Hazard warning lights switching on

Depending on the vehicle, these may flash in the event of sudden deceleration.

Electronic stability control ESC with understeer control and traction control

Electronic stability control ESC

This system helps you to keep control of the vehicle in critical driving situations (avoiding an obstacle, loss of grip on a bend, etc.).

Operating principle

A sensor at the steering wheel makes it possible to determine the driving trajectory desired by the driver.

Other sensors throughout the vehicle measure the actual trajectory.

The system compares driver input to the actual trajectory of the vehicle and corrects the trajectory if necessary by controlling the braking of certain wheels and/or engine power. In the event that the system is triggered, the





warning light flashes on the instrument panel.

Operating faults

When the system detects an operating fault, the "Check ESC" message and



the  and  warning lights are displayed on the instrument panel. In this case, the ESC and traction control system are deactivated.

Consult an approved Dealer.

Understeer control

This system optimises the action of the ESC in the case of pronounced understeering (loss of front axle road holding).

Traction control

This system helps to limit wheelspin of the drive wheels and to control the vehicle when pulling away, accelerating or decelerating.

Operating principle

Using the wheel sensors, the system measures and compares the speed of the drive wheels at all times and slows down their over-rotation. If a wheel is starting to slip, the system brakes automatically until the drive supplied becomes compatible with the level of grip under the wheel again.

DRIVER CORRECTION DEVICES AND AIDS

The system also adjusts the engine speed to the grip available under the wheels, independently of the pressure exerted on the accelerator pedal.

In some situations (driving on very soft ground such as snow or mud, or driving with snow chains fitted), the system may reduce the engine power to limit wheelspin.

Disabling and activating the traction control

(depending on the vehicle)



When starting on snow, ice or soft ground (mud, sand, gravel), the traction control system can be deactivated from the multimedia screen **2**.

When the system is deactivated, the



warning light appears on the instrument panel.

Please refer to the multimedia instructions for more information.

Note: the system is automatically re-activated:

- when the vehicle speed exceeds approximately 31 mph (50 km/h);
- when the vehicle is started again.

If the warning light does not appear on the instrument panel, this confirms that the system is once again activated.



Deactivating of the traction control function causes temporary unavailability of certain driving aid functions (Active Emergency Braking, etc.).

Hill start assist

Depending on the gradient of the incline, this system assists the driver when starting on a hill. It prevents the vehicle from rolling backwards, depending on the slope, by automatically applying the brakes when the driver lifts his/her foot off the brake pedal to depress the accelerator pedal.

System operation

It operates only when the gear lever is in a non-neutral position (position other than **N** or **P** for automatic transmissions) and the vehicle is completely stationary (brake pedal depressed).

The system holds the vehicle for approximately **2 seconds**. The brakes are then released (the vehicle will move according to the slope).

If the system detects an operating

fault, the  warning light and, depending on the vehicle, the "Check Hill Start Assist" message is displayed on the instrument panel. Consult an approved Dealer.

DRIVER CORRECTION DEVICES AND AIDS



The hill start assistance system cannot completely prevent the vehicle from rolling backwards in all situations (extremely steep gradients etc.).

In all cases, the driver may depress the brake pedal to prevent the vehicle from rolling backwards.

The Hill Start Assist function should not be used for prolonged stops: use the brake pedal.

This function is not designed to immobilise the vehicle permanently.

If necessary, use the brake pedal to stop the vehicle.

The driver must remain particularly vigilant when driving on slippery or low-grip surfaces.

Risk of serious injury.



These functions are an additional aid in the event of critical driving conditions, enabling the vehicle behaviour to be adapted to suit the driving conditions.

The functions do not take the place of the driver. **They do not increase the vehicle's limits and should not encourage you to drive more quickly.** Therefore, they can under no circumstances replace the vigilance or responsibility of the driver when manoeuvring the vehicle (the driver must always be ready for sudden incidents which may occur when driving).



"Automatic" mode

The default "Automatic" mode enables optimal use under normal road conditions (dry, wet, light snow, etc.).

"Automatic" mode uses traction control functions.



The "Soft ground" mode causes a temporary unavailability of certain driving assistance functions (Active emergency braking, etc.).

Traction control - "Extended grip"

If fitted on the vehicle, traction control makes it easier to control the vehicle on low grip surfaces (soft ground, etc.).

DRIVER CORRECTION DEVICES AND AIDS



After the engine stops, the vehicle will always restart in "Automatic" mode.

3

"Soft ground" mode

Press and hold switch **1**: the  warning light and, depending on the

vehicle, the  warning light appear on the instrument panel accompanied by the "Grip Extend Loose Surface ON" message. This position enables optimal usage on soft ground (mud, sand, dead leaves, etc.). In this position, engine speed is left under the driver's control.

If the **1** switch is pressed again, the



warning light and, depending on

the vehicle, the  warning light(s) is/are switched off and the "Automatic mode activated" message is displayed on the instrument panel to warn you.

ADDITIONAL DRIVING AID FUNCTIONS

My Safety

The "My Safety" function can be used to deactivate or activate a set of driving assistance functions simultaneously.

Depending on the vehicle, you can configure the "My Safety" function from the multimedia screen or from the instrument panel by selecting the driving aid functions to be switched off as a group.

Operation



"ALL ON " mode

Depending on the vehicle, this mode includes the following driving assistance functions:

- overspeed sound alert → 132;
- lane departure prevention → 214;
- driver vigilance warning → 238;
- driver fatigue warning → 243;
- driver distraction warning → 240;
- blind spot warning → 222;

When "ALL ON" mode is activated: the indicator light on button **1** lights up and the "My Safety All ON selected" message appears on the instrument panel to confirm this. The driving aids that are available in the mode are activated.

"Perso " mode

This mode allows you to **deactivate** or **reactivate** certain driving aid functions available in the "ALL ON" mode.

With the ignition on, **press** button **1** twice in succession to activate "Perso" mode.

The first time you press it, the "Press again for My Safety Perso" message appears on the instrument panel. On the second press, the indicator light on the button **1** goes out. "Perso" mode is activated. The "My Safety Perso selected" message is displayed on the instrument panel.

To switch back to "ALL ON" mode, **press once** on button **1**. The indicator light on button **1** lights up.



Depending on the vehicle, according to the length of time following the last time the engine was stopped, the function is reactivated:

- when the vehicle is unlocked;
- or
- when a door is opened;
- or
- when the engine is restarted.

Configuration of "My Safety Perso"



For safety reasons, carry out any adjustments while the vehicle is stationary.

ADDITIONAL DRIVING AID FUNCTIONS



The "My Safety Perso" settings saved for "Perso" mode are stored each time the engine is or when the doors are locked.

3

Vehicle fitted with a multimedia screen



Refer to the multimedia instructions 2 for information on accessing the settings.

Vehicle not fitted with a multimedia screen

(depending on the vehicle)



Configuration from the trip computer 3

– With the vehicle stationary, press the switch 4 as many times as re-

quired to reach the  tab;

or

– press control 4 and repeatedly press

control 5 or 6 to reach the  tab;

– press the 7 "OK" switch

– repeatedly press control 5 or 6 to

reach the  menu, then press the 7 "OK" switch;

– repeatedly press control 5 or 6 to reach the "MY SAFETY PERSO" menu, then press switch 7 "OK";

– select the driving aids to be deactivated or activated from "Perso" mode by repeatedly pressing control 5 or 6, then press the 7 "OK" switch to deactivate or activate the driving aids.

Lane departure prevention



Using information from the 1 camera, the function triggers corrective action on the vehicle steering system when a continuous or broken line is crossed or when approaching the roadside (divider, barrier, pavement, embankment, etc.) without activating the direction indicator lights.

Depending on the setting, in the event of crossing a broken line without activ-

ADDITIONAL DRIVING AID FUNCTIONS

ating the direction indicator lights, the function:

- warns the driver without corrective action on the steering system;

or

- performs corrective action on the steering system.

Location of the camera 1

Make sure the windscreen is not obscured (by dirt, mud, snow, condensation etc.).



You can retake control of the vehicle at any time by operating the steering

wheel.



This function is an additional driving aid. This function is not under any circumstances intended

to replace the due care and attention of the driver, who should at all times be in control of the vehicle.

Activation/deactivation

Vehicles fitted with the "My Safety" function 2



To deactivate the function, press the 2 switch twice. Depending on the

vehicle, the warning light  is displayed in yellow or white on the instru-

ment panel, or the warning light  disappears from the instrument panel.

To reactivate the function, press the 2 switch once.

Depending on the vehicle, the warning

light  is displayed in grey on the instrument panel.

Vehicles fitted with a multimedia screen 3



Please refer to the multimedia instructions for further information.

Vehicles not fitted with a multimedia screen

(depending on the vehicle)

ADDITIONAL DRIVING AID FUNCTIONS



– **With the vehicle stationary**, press the switch **4** as many times as re-

quired to reach the  tab;

or

– press switch **4** and repeatedly press

control **5** or **6** to reach the  tab;

– press the **7 "OK"** switch

– repeatedly press control **5** or **6** to

reach the  menu, then press the **7 "OK"** switch;

– repeatedly press control **5** or **6** to reach the "DRIVING ASSIST" menu, then press the **7 "OK"** switch;

– repeatedly press control **5** or **6** to reach the "Lane keeping" menu, then press the **7 "OK"** switch;

– press switch **7 "OK"** again to activate or deactivate the function:

–  function activated;

–  function deactivated.

When the function is deactivated, depending on the vehicle, the warning

light  is displayed in yellow or white on the instrument panel, or the

warning light  disappears from the instrument panel.

 Depending on the vehicle, according to the length of time following the last time the engine was stopped, the function is reactivated:

– when the vehicle is unlocked;

or

– when a door is opened;

or

– when the engine is restarted.

Operation



When the function is activated, the

warning light  is displayed in grey on the instrument panel and the left-hand and right-hand line indicators **8** are displayed in grey on the instrument panel.

The function is set to notify or react if:

– the speed is between about 40 mph (65 km/h) and 105 mph (170 km/h);

– the warning light  is displayed in white and the left-hand or right-hand line indicators **8** are displayed in white on the instrument panel.

ADDITIONAL DRIVING AID FUNCTIONS



The function is in operation if the vehicle:

- approaches a roadside without activating the direction indicators;
- crosses a continuous line without activating the direction indicators;
- crosses a broken line without activating the direction indicators, if the "Operation on broken line" setting is selected.

In these cases:

- the function triggers an action on the vehicle's steering system to correct the vehicle trajectory;

and

- the warning light  flashes white or, depending on the vehicle, the warning light  is displayed in yellow and the indicator **B** on the side of the breached line is displayed in yellow on the instrument panel.

In certain cases, if the corrective action taken on the steering system is not

sufficient, the  warning light will continue to flash in white or, depending



on the vehicle, the  warning light is displayed in red and the indicator light **B** on the side of the breached line changes to red on the instrument panel.

el. This is accompanied by a vibration on the steering wheel.

When the "Operation on broken line" setting is not selected, **the function sounds the alarm** if the vehicle crosses a broken line without activating the direction indicator lights, and there is no roadside close enough to the line.

In this case, the function warns the driver:

- by a vibration in the steering wheel; and

- the warning light  flashes white or depending on the vehicle, the warning light  is displayed in red and the indicator **B** on the side of the breached line turns red on the instrument panel.

Note: on bends, the function allows for slightly cutting the bend.

Special cases

"Keep control" alert.

- If the system is operating and does not detect any activity on the steering wheel, the "Keep control" message appears on the instrument panel accompanied by a beep and, depending on

the vehicle, the  warning light ap-

pears in yellow until the driver has regained control of the vehicle.

or

- If the system has been in operation for too long, the message "Keep control" appears on the instrument panel accompanied by a sound alert and, de-

pending on the vehicle, the  warning light in yellow and the indicator **B** on the side of the line concerned flashing until the driver has regained control of the vehicle.



You can interrupt the trajectory correction at any time by moving the steering wheel.

Function temporarily unavailable/disabled

The function is temporarily unavailable or disabled in the following cases:

- very fast lane departure;
- driving continuously on a line;
- approximately four seconds after changing lanes;
- tight bends;
- impaired visibility;
- one of the direction indicators is activated;

ADDITIONAL DRIVING AID FUNCTIONS

- activating the hazard warning lights;
- engaging reverse gear;
- strong acceleration;
- the lane width changes;
- operation of the electronic stability control ESC;
- operation of the anti-lock braking system.
- the active emergency braking system is triggered;

If the front camera is obscured, the "Front camera no visibility" message is displayed on the instrument panel.

Clean the area where the sensors are located.

Automatic deactivation

The function is automatically deactivated when:

- the electronic stability control ESC is deactivated or malfunctions;
- the anti-lock braking system is malfunctioning;
- A towbar is electrically connected to the trailer hitch socket;
- the **STOP** warning light is displayed.

When the function is deactivated, depending on the vehicle, the warning

light  is displayed in yellow or white on the instrument panel, or the

warning light  disappears from the instrument panel.

Settings

Vehicle fitted with a multimedia screen 3



To access the multimedia screen function settings **3**, refer to the multimedia instructions:

- "Operation on broken lines": use this setting to select the response of the function if the vehicle crosses a broken line without one of the direction indicators having been activated:
 - selected setting: the function may trigger an action on the vehicle's

steering system to correct the vehicle trajectory;

- setting not selected: the function can warn the driver by means of a vibration at the steering wheel without correcting the vehicle trajectory.

- "VIBRATION": adjust the steering wheel vibration for the "Lane departure prevention" function;
- depending on the vehicle, "Lane exit anticipation" or "Warning": adjust the line detection sensitivity level. To do this, select:

- "Late": line detected upon crossing;
- "Standard": line detected on approach;
- "Early" line detected nearby.

Please refer to the multimedia instructions for further information.

Vehicle not fitted with a multimedia screen

(depending on the vehicle)

ADDITIONAL DRIVING AID FUNCTIONS



– **With the vehicle stationary**, press the switch **4** as many times as re-

quired to reach the  tab;

or

– press switch **4** and repeatedly press

control **5** or **6** to reach the  tab;

– press the **7 "OK"** switch

– repeatedly press control **5** or **6** to

reach the  menu, then press the **7 "OK"** switch;

– repeatedly press control **5** or **6** to reach the "DRIVING ASSIST" menu, then press the **7 "OK"** switch;

– repeatedly press control **5** or **6** to reach the "Lane Keep Assist sensitiv-

ity" menu, then press the **7 "OK"** switch;

– repeatedly press control **5** or **6** to select the setting, then press on switch **7 "OK"**.

Operating faults

When the system detects an operating fault:

– the warning light  is displayed in yellow or in white on the instrument panel;

or, depending on the vehicle

– the warning light  is displayed on the instrument panel.

In some cases, they are accompanied by:

– the "Driving assist unavailable" message;

or

– the "Check Driving assist" message;

or

– the "Check Front camera" message.

In these cases, please contact an Approved Dealer.

ADDITIONAL DRIVING AID FUNCTIONS

Warnings



This function is an additional driving aid. This function is not under any circumstances intended to replace the due care and attention of the driver, who should at all times be in control of the vehicle.

System servicing/repairs

- In the event of an impact, the camera alignment may be changed, and its operation may consequently be affected. Deactivate the function and consult an approved Dealer.
- Any work in the area where the camera is located (replacements, repairs, windscreen modifications etc.) must be carried out by a qualified professional.

Only an approved Dealer is qualified to service the system.

In the event of system disturbance

Some conditions can disturb or damage the operation of the system, such as:

- windscreen obscured (by dirt, ice, snow, condensation etc.) ;
- a complex environment (tunnel etc.) ;
- poor weather conditions (snow, rain, hail, black ice etc.) ;
- poor visibility (night, fog etc.) ;
- multiple road markings (roadworks, etc.), difficult to distinguish or irregular lines (e.g. partially faded lines, lines too far apart, uneven road surface, etc.) ;
- being dazzled (glaring sun, lights of vehicles travelling in the opposite direction etc.) ;
- the road is narrow, winding or undulating (tight bends etc.) ;
- closely following a vehicle travelling in the same lane.

In this case, the "Lane departure prevention" function may be activated incorrectly or not at all.

Risk of unwanted, incorrect correction or no correction of trajectory.

Deactivating the function

You must disable the function if:

- the area of the camera has been damaged (on the windscreen side or the interior rear-view mirror side);
- the road is slippery (snow, black ice, aquaplaning, gravel etc.) ;

ADDITIONAL DRIVING AID FUNCTIONS

- the windscreen is cracked or distorted (do not carry out windscreen repairs in this area; have it changed by an approved Dealer);
- the vehicle is towing a trailer or a caravan;

ADDITIONAL DRIVING AID FUNCTIONS

Blind spot warning

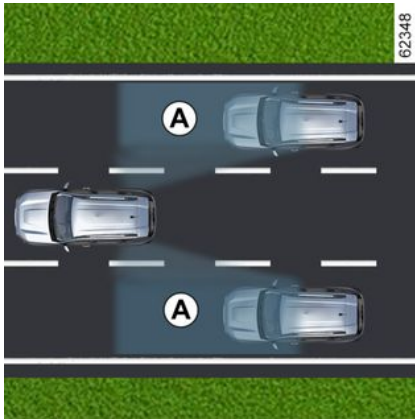

This system alerts the driver to other vehicles in the detection zone **A**.

The system is activated when the vehicle's speed is between approximately 19 mph (30 km/h) and 87 mph (140 km/h).

This function uses sensors **1** installed in the front and rear bumper of both sides.

Special feature

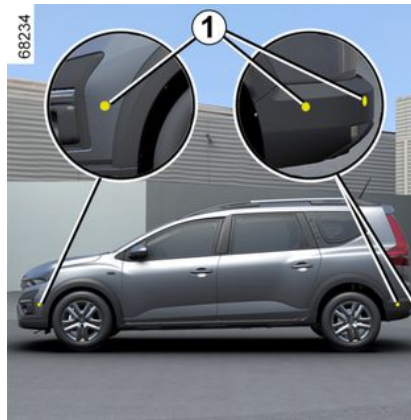

Make sure that the sensors are not obscured (by dirt, mud, snow, etc.).

If a sensor is obscured, the message "Blind spot clean sensor" is displayed on the instrument panel. Clean the sensors.



This function is an additional aid which indicates other vehicles in the blind spot area.

It can never in any case be a substitute for care nor for the driver's responsibility while in charge of his vehicle.

The driver should always be ready for sudden incidents while driving: always ensure that there are no moving obstacles (such as a child, animal, pushchair, bicycle, etc.) or small, narrow objects (such as stones or posts, etc) in the blind spot when manoeuvring.

ADDITIONAL DRIVING AID FUNCTIONS

Activation/deactivation



To activate or deactivate the function, refer to the multimedia instructions **2**. Choose **"ON"** or **"OFF"**.

Activating, deactivating the function using the 3 "My Safety" button.



The function can be deactivated or activated using the "Perso" mode of the "My Safety" function → **213**.

If the function has previously been deactivated from "Perso" mode:

- **to deactivate the alerts**, press the button **3** twice. The indicator light on the button **3** goes out;
- **to reactivate alerts**, press the button **3** once. The indicator light on the button **3** lights up.

 The system's detection range operates according to a standard lane width. If you are driving in narrow traffic lanes, it may detect vehicles in other lanes.

3

Warning light 4

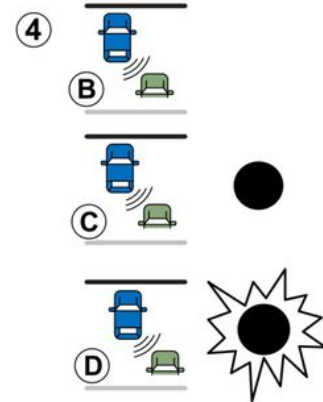

A warning light **4** is located on each door mirror **5**.

Note: clean the door mirrors **5** regularly so that the warning lights **4** remain visible.

ADDITIONAL DRIVING AID FUNCTIONS

Operation



This function gives a warning:

- when the vehicle speed is between approximately 19 mph (30 km/h) and 87 mph (140 km/h);
- when another vehicle is in the blind spot area and travelling in the same direction as your vehicle.

If another vehicle is being overtaken, the indicator **4** will be activated only if that vehicle remains in the blind spot for more than one second.

Display **B**

The function is activated and has not detected any vehicles.

Display **C**

First warning: the warning light **4** signals that a vehicle has been detected in the blind spot area.

Display **D**

When the direction indicator is activated, the warning light **4** flashes when a vehicle is detected in the blind spot on the side towards which you are about to steer. If you cancel the direction indicator, the function will return to the initial warning (display **C**).



Because sensors have been installed in the bumpers, any work (repairs, replacements, touching up of paintwork) must be carried out by a qualified professional.

Conditions for non-function

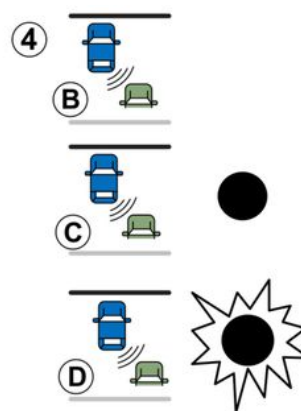

- If the object is not moving;
- if traffic is heavy;
- if the road is winding;
- if front and rear sensors both detect an object at the same time (e.g. when passing an articulated lorry);
- ...

Operating faults

If the system detects a fault, the message “Check blind spot alert” is displayed on the instrument panel. Call an approved Dealer.

Note: when the engine is started, the warning light **4** on display **B**, flashes three times. This is normal.

ADDITIONAL DRIVING AID FUNCTIONS

Warnings



- The system's detection range operates according to a standard lane width. If you are driving in wide traffic lanes, the system might not be able to detect a vehicle in the blind spot.
- In the event of very bad weather conditions (heavy rain, snow, etc.), the system may be temporarily disrupted.

Remain aware of driving conditions.

There is a risk of accidents.



This function is an additional driving aid. This function is not under any circumstances intended to replace the due care and attention of the driver, who should at all times be in control of the vehicle.

The driver should always adapt their speed to the traffic conditions, regardless of the system indications.

The system should under no circumstances be taken to be an obstacle detector or an anti-collision system.

System servicing/repairs

- In the event of an impact, radar alignment may be changed, and its operation will consequently be affected. Deactivate the function and consult an authorised dealer.
- Any work in the area where the radars are located (repairs, replacements, etc.) must be carried out by a qualified professional.

Only an authorised dealer is qualified to service the system.

System disturbance

Some conditions can disturb or damage the system's operation, such as:

- complex surroundings (metal bridges, tunnels, roads with barriers at the edge, etc.);
- poor weather conditions (snow, hail, black ice, etc.).

Risk of false alarms or absence of warnings

In the event of the system behaving abnormally, deactivate it and contact an authorised dealer.

ADDITIONAL DRIVING AID FUNCTIONS



Limitation of the system operation

- The radar area should be kept clean and free of any modifications in order to ensure the proper operation of the system.
- Small objects moving close to the vehicle (motorcycles, bicycles, pedestrians, etc.) may not be recognised by the system.
- When the vehicle enters corners and curves, detectors may temporarily no longer detect vehicles in adjacent lanes.
- The system does not give a warning when the right and left radars simultaneously detect vehicles moving at similar speeds (e.g. traffic on a three lane road).
- The system may not react when there is a significant difference in speed with other vehicles.
- If the vehicle is being overtaken by a long vehicle (e.g. heavy goods vehicle overtaking at a similar speed to the vehicle) the system may interrupt the warning before the end of the manoeuvre.
- The vehicle is travelling on a winding road.

Deactivating the function

You must deactivate the function if:

- the radar area has been damaged (rear bumper);
- the vehicle is fitted with a towbar.

ADDITIONAL DRIVING AID FUNCTIONS

Safe distance alert



Using the information from the camera **1**, this function informs the driver of the time interval between their vehicle and the vehicle in front so that a safe stopping distance between the two vehicles can be maintained.

The function is activated when the vehicle speed is between approximately 19 and 124 mph (30 and 200 km/h), depending on the vehicle.

Location of camera 1

Make sure the windscreen is not obscured (by dirt, mud, snow, condensation etc.).



This function is an additional driving aid. This function is not under any circumstances intended to replace the due care and attention of the driver, who should at all times be in control of the vehicle.

Activating/deactivating the function



Vehicles fitted with a multimedia screen 2

From the "Vehicle" world on your multimedia screen **2**, press the "Driving assistance" menu.

Activate or deactivate the "Following distance" function.



Vehicles not fitted with a multimedia screen

(depending on the vehicle)



– **With the vehicle stationary**, press the switch **3** as many times as re-

quired to reach the  tab;
or

– press control **3** and repeatedly press control **4** or **5** to reach the

 tab;
– press switch **6** "OK";

ADDITIONAL DRIVING AID FUNCTIONS

- repeatedly press control **4** or **5** to reach the  menu, then press the **6** "OK" switch;
- repeatedly press control **4** or **5** to reach the "DRIVING ASSIST" menu, then press switch **6** "OK";
- repeatedly press control **5** or **6** to reach the "Distance warning" menu, then press switch **6** "OK";
- press switch **6** "OK" again to activate or deactivate the function:
 -  function activated;
 -  function deactivated.



Each time the vehicle is started, the function continues the mode saved the last time the engine was stopped.

Operation

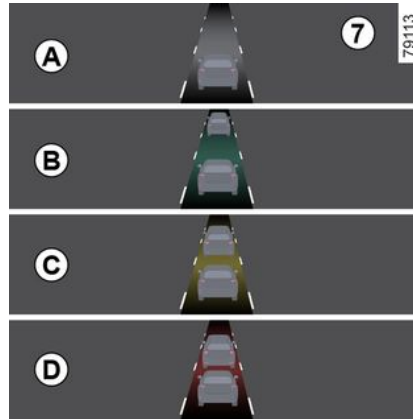

With the function activated, the **7** indicator is displayed on the instrument panel and informs the driver of the distance between their vehicle and the vehicle in front.

- **A** (grey): function not operational;
- **A** (green): no vehicle detected;
- **B** (green): the time interval is greater than or equal to around two seconds (distance between the two vehicles adapted to your speed);
- **C** (yellow): the time interval is between approximately one and two seconds (insufficient distance between the two vehicles);
- **D** (red): the time interval is less than or equal to around one second

(very insufficient distance between the two vehicles).

If the interval between the two vehicles is less than around 0.5 seconds, notification **7**, display **D**, will remain lit red on the instrument panel.

Under certain conditions, the time interval may not be displayed:

- while cornering;
- when changing lane;
- if the vehicle in front is sufficiently far or outside the range of the camera.

ADDITIONAL DRIVING AID FUNCTIONS

Warnings



The measurement is displayed for information: the system does not carry out any action on the vehicle. This function is not designed for use in urban conditions or for a dynamic driving style (sudden cornering, acceleration, braking, etc.), but rather for stable driving conditions.

The function does not interact with the braking system.

the camera should be kept clean and free of any modifications in order to ensure the proper operation of the system.

Any work in the area where the camera is located (repairs, replacements, windscreen modifications etc.) must be carried out by a qualified professional.

ADDITIONAL DRIVING AID FUNCTIONS



This function is an additional driving aid. This function is not under any circumstances intended to replace the due care and attention of the driver, who should at all times be in control of the vehicle.

System servicing/repairs

- In the event of an impact, the camera alignment may be changed and its operation may consequently be affected. Deactivate the function and consult an approved Dealer.
- Any work in the area where the camera is located (repairs, replacements, windscreen modifications etc.) must be carried out by a qualified professional.

Only an approved Dealer is qualified to service the system.

In the event of system disturbance

- windscreen obscured (by dirt, ice, snow, condensation etc.);
- a complex environment (metal bridge, tunnel, etc.);
- poor weather conditions (snow, hail, black ice, etc.);
- poor visibility (night, fog, etc.);
- poor contrast between the vehicle preceding it and the surrounding area (e.g. white vehicle in a snowy area, etc.);
- being dazzled (glaring sun, lights of vehicles travelling in the opposite direction; etc.);
- the road is narrow, winding and undulating (tight bends etc.)

Risk of erroneous false alarms.

ADDITIONAL DRIVING AID FUNCTIONS

Active emergency braking



The system uses information from the camera **1**, to determine the distance from your vehicle:

- from the vehicle ahead in the same lane;

or

- from any oncoming vehicles in the context of a manoeuvre to change direction;

or

- and vehicles passing perpendicularly;

or

- and stationary vehicles;

or

- surrounding pedestrians and cyclists.

The system informs the driver if there is a risk of head-on collision to enable appropriate emergency manoeuvres (pressing the brake pedal and/or turning the steering wheel).

Depending on the reactivity of the driver, the system can assist with braking in order to limit damage or prevent a collision.

The system is otherwise inactive and does not trigger an alert.



This function is an additional driving aid.

This function is not under any circumstances intended to replace the due care and attention of the driver, who should at all times be in control of the vehicle.



This system can apply maximum braking to the vehicle until it is completely stationary if necessary.

For safety reasons, always wear your seat belt when travelling in your vehicle and make sure that it is loaded so that no items can be thrown forward and hit the occupants.

Location of the camera **1**

Make sure the windscreen is not obscured (by dirt, mud, snow, condensation etc.).

Operation

When driving, when there is a risk of collision, the system:

- **alerts you of a collision risk:** the "Detected obstacle" message appears on the instrument panel accompanied by a beep.

Note: if the driver presses the brake pedal and the system still detects a risk of collision, the braking force may be increased if it is not sufficient to prevent the collision.

- **braking may be triggered:** if the driver does not react to the alert and

ADDITIONAL DRIVING AID FUNCTIONS

the collision becomes imminent, the

red  warning light and the "Brake" message are displayed on the instrument panel accompanied by a beep.

Note:

- if the driver uses the vehicle controls (steering wheel, pedals, etc.) the system may delay its reaction or not activate;
- if active emergency braking has caused the vehicle to stop, the vehicle is kept stationary for a short time. Beyond this time limit, the driver must keep the vehicle stationary by holding their foot on the brake pedal;
- after the system activates braking, the "Advanced Safety triggered" message will be displayed.

-  In the event of an emergency manoeuvre, you can stop the braking at any moment by:
- tapping the accelerator pedal;
- or
- turning the steering wheel as a collision avoidance manoeuvre.

 **Special features of warnings**

Depending on the speed, the warning and braking may be activated simultaneously.

Detection of vehicles

Detection of vehicles travelling in the same lane

The risk of a collision with the vehicle in front of you in the same lane is detected by the system when:

- your vehicle is travelling at a speed between approximately 3 mph (5 km/h) and 112 mph (180 km/h).

Detection of oncoming vehicles in the context of a manoeuvre to change direction

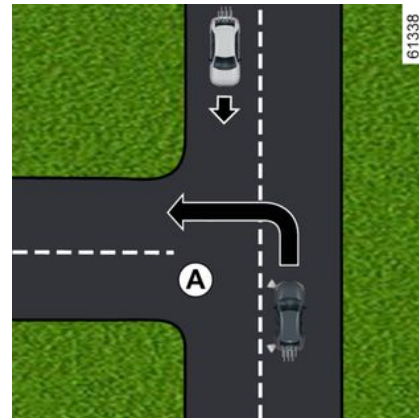

When you wish to change direction (e.g. **A**), oncoming vehicles are detected by the system when:

- your vehicle is travelling at a speed between approximately 4 mph (7 km/h) and 19 mph (30 km/h).
- you have activated the direction indicator light.

Detection of vehicles crossing the lane perpendicularly

Vehicles crossing the lane perpendicularly are detected by the system when:

ADDITIONAL DRIVING AID FUNCTIONS

– your vehicle is travelling at a speed between approximately 3 mph (5 km/h) and 53 mph (85 km/h).

Detection of vehicles stopped in the lane

Stationary vehicles are detected by the system when:

– your vehicle is travelling at a speed between approximately 3 mph (5 km/h) and 53 mph (85 km/h).

Detection of pedestrians and cyclists

Detection of pedestrians and cyclists in the same lane

The system detects pedestrians and cyclists when:

– your vehicle is travelling at a speed between approximately 3 mph (5 km/h) and 53 mph (85 km/h).

Detection of pedestrians and cyclists when changing direction

The system detects pedestrians and cyclists when:

– your vehicle is travelling at a speed between approximately 4 mph (7 km/h) and 19 mph (30 km/h).

Activation/deactivation

 Depending on the vehicle, according to the length of time following the last time the engine was stopped, the function is reactivated:

- when the vehicle is unlocked;
- or
- when a door is opened;
- or
- when the engine is restarted.

Activating, deactivating the system from the multimedia screen 2



To activate or deactivate the function, please refer to the multimedia instructions.

Select "ON" or "OFF".

Activating, deactivating the system from the trip computer 3

(depending on the vehicle)

ADDITIONAL DRIVING AID FUNCTIONS



– **With the vehicle stationary**, press the switch **4** as many times as re-

quired to reach the  tab;

or

– press switch **4** and repeatedly press

control **5** or **6** to reach the  tab;

– press the **7 "OK"** switch

– repeatedly press control **5** or **6** to

reach the  menu, then press the **7 "OK"** switch;

– repeatedly press control **5** or **6** to reach the "DRIVING ASSIST" menu, then press the **7 "OK"** switch;

– repeatedly press control **5** or **6** to reach the "Active braking" menu, then press the **7 "OK"** switch;

– Press the **7 "OK"** switch again to activate or deactivate the function:

–  function activated;

–  function deactivated.

Upon deactivation of the system, the

 warning light illuminates or, de-

pending on the vehicle, the  warning light illuminates on the instrument panel. When the system is activated, the warning light disappears.

Settings



For safety reasons, carry out any adjustments while the vehicle is stationary.

Adjusting settings from the multimedia screen 2

(depending on the vehicle)



With the vehicle stationary, to access the function settings from the multimedia screen **2**; refer to the multimedia instructions:

– "Alert": adjust the alert sensitivity level. To do this select:

– « Late » ;

– « Standard » ;

– « Early ».

Please refer to the multimedia instructions for further information.

ADDITIONAL DRIVING AID FUNCTIONS

Settings from the trip computer 3



– **With the vehicle stationary**, press the switch **4** as many times as re-

quired to reach the  tab;
or

– press switch **4** and repeatedly press

control **5** or **6** to reach the  tab;

– press the **7 "OK"** switch

– repeatedly press control **5** or **6** to

reach the  menu, then press the **7 "OK"** switch;

– repeatedly press control **5** or **6** to reach the "DRIVING ASSIST" menu, then press the **7 "OK"** switch;

– repeatedly press control **5** or **6** to reach the "Active braking sensitivity" menu, then press the **7 "OK"** switch;

– repeatedly press control **5** or **6** to select the setting, then press on switch **7 "OK"**.

Temporarily not available

If the system detects a temporary fault

the  warning light illuminates, or

depending on the vehicle the  warning light illuminates on the instrument panel.

The possible causes are:

- the system is temporarily blinded (glare from the sun, dipped beam headlights, bad weather conditions etc.). The system will be operational again when visibility conditions are better;
- the system is temporarily disrupted (for example: the windscreen is obscured by dirt, snow, condensation, etc.). In this case, park the vehicle and switch off the engine. Clean the windscreen. The next time the engine is started, after around five or ten minutes of driving, the warning light and the message disappear. If this is not the case, this may arise from another cause; contact an approved dealer.

Operating faults

When the function detects an operat-

ing fault, the  warning light or,

depending on the vehicle, the  warning light appears on the instrument panel.

Consult an approved Dealer.

ADDITIONAL DRIVING AID FUNCTIONS

Warnings



This function is an additional driving aid. This function is not under any circumstances intended to replace the due care and attention of the driver, who should at all times be in control of the vehicle.

The triggering of this function may be delayed or prevented when the system detects clear signs of control of the vehicle by the driver (action on the steering wheel, pedals etc.).

The system cannot be activated when:

- the Electronic Stability Control (ESC) has been triggered.

System servicing/repairs

- In the event of an impact, the camera alignment may be changed, and its operation may consequently be affected. Deactivate the function and consult an approved Dealer.
- Any work in the area where the camera is located (replacements, repairs, windscreen modifications, etc.) must be carried out by a qualified professional.

Only an approved Dealer is qualified to service the system.

System disturbance

Some conditions can disturb or damage the operation of the system, such as:

- poor weather conditions (snow, rain, hail, black ice etc.) ;
- poor visibility (night, fog etc.) ;
- poor contrast between the object (vehicle, pedestrian etc.) and the surrounding area (e.g. pedestrian dressed in white located in a snowy area etc.) ;
- being dazzled (glaring sun, lights of vehicles travelling in the opposite direction etc.) ;
- windscreen obscured (by dirt, ice, snow, condensation etc.) ;
- ...

In these conditions, the system may not react, may warn the driver or may brake inadvertently.

Limitation of the system operation

- Each time the vehicle is started, the system carries out a calibration according to the vehicle surroundings and may be inactive for a length of time between approximately two to five minutes of driving;
- the camera should be kept clean and free of any modifications in order to ensure the proper operation of the system;

ADDITIONAL DRIVING AID FUNCTIONS

- the system may not respond to small vehicles as effectively as to other vehicles;
- the system may not operate properly when the road surface is slippery (rain, snow, black ice, etc.) ;
- to ensure correct operation, the system needs to distinguish the entire obstacle. So the system cannot detect:
 - pedestrians/cyclists in the darkness or in poor lighting conditions;
 - partially visible pedestrians/cyclists;
 - pedestrians less than approximately 80 cm tall;
 - pedestrians carrying large objects;
 - ...

In these conditions, the system may not react, may warn the driver or may brake inadvertently.

Deactivating the function

You must disable the function if:

- the area of the camera has been damaged (e.g. on the inside or outside of the windscreen);
- the vehicle is being towed (breakdowns);
- the windscreen is cracked or distorted (do not carry out windscreen repairs in this area; have it changed by an approved Dealer);
- you are not driving on a paved road.

In the event of the system behaving abnormally, deactivate it and contact an approved Dealer.

Halting the function

You can halt the active braking function at any time by tapping the accelerator pedal or by turning the steering wheel in a collision avoidance manoeuvre.

ADDITIONAL DRIVING AID FUNCTIONS

Driver vigilance warning

The driver vigilance warning is a function that analyses the behaviour of the driver (driving style, vehicle steering, etc.) and alerts them if there is a risk of falling asleep.

It takes into account indicators such as:

- steering wheel movements;
- driver actions on other systems (indicators, brake pedal, etc.).



This function is an additional driving aid in case of risk of fatigue. The function does not operate on the vehicle. The function cannot, under any circumstances, replace the driver's responsibility during driving.

The driver must always adapt their driving according to their alertness, regardless of the system's indications.

Operation



The function is set to notify the driver if:

- a few minutes have elapsed since the vehicle last stopped;
- the vehicle speed is greater than approximately 43 mph (70 km/h).

If there is a risk of fatigue or impaired attention, the "Vigilance alert Have a break" message is displayed on the instrument panel **1** accompanied by a beep.

Press switch **5 "OK"** to delete the warning. It is advisable to stop as soon as possible for a break.

After deleting the message, the system continues vigilance monitoring and issues a new warning if necessary.



The driver vigilance warning constantly monitors the driver's attention and can provide several warnings per journey.

The system resets every time the engine is started.

Warning activation/deactivation



For safety reasons, carry out any adjustments while the vehicle is stationary.

ADDITIONAL DRIVING AID FUNCTIONS

- i** Depending on the vehicle, according to the length of time following the last time the engine was stopped, the alerts are reactivated:
- when the vehicle is unlocked;
 - or
 - when a door is opened;
 - or
 - when the engine is restarted.

- i** When the alerts are deactivated, the system continues to assess the driver's state of fatigue.

Activating, deactivating alerts using the **6** "My Safety" button



- **To deactivate the alerts**, press the button **6** twice;
- **To reactivate the alerts**, press the button **6** once.

Activating and deactivating the alerts from the multimedia screen **7**



To activate or deactivate the alerts, please refer to the multimedia instructions.

Select **"ON"** or **"OFF"**.

Activating, deactivating the alerts from the trip computer **1**

(depending on the vehicle)

ADDITIONAL DRIVING AID FUNCTIONS



– **With the vehicle stationary**, press the switch **2** as many times as re-

quired to reach the  tab;

or

– press switch **2** and repeatedly press

control **3** or **4** to reach the  tab;

– press the **5** "OK" switch

– repeatedly press control **3** or **4** to

reach the  menu, then press the **5** "OK" switch;

– repeatedly press control **3** or **4** to reach the "DRIVING ASSIST" menu, then press the **5** "OK" switch;

– repeatedly press control **3** or **4** to reach the "Vigilance warning" menu, then press the **5** "OK" switch;

– press the **5** "OK" switch again to activate or deactivate the alerts:

–  warnings enabled;

–  warnings deactivated.

Limitations of system operation

Some conditions can disrupt or damage the operation of the system, for example:

- certain driving styles (incorrect driving etc.) ;
- driving on a road in poor condition;
- strong side wind;
- The clock is wrongly configured (depending on vehicle);
- winding roads;
- trailer traction.

Operating faults

If the system detects a fault, the "Vigilance monit. to check" message and

the  warning light are displayed on the instrument panel.

Have the system checked by an authorised dealer.

Driver attention warning

Introduction



This function is an additional driving aid in case of a risk of distraction.

The function does not operate on the vehicle. The function cannot, under any circumstances, replace the driver's responsibility during driving. The driver must always adapt their driving according to their alertness, regardless of the system's indications.

ADDITIONAL DRIVING AID FUNCTIONS



The system analyses the behaviour of the driver's face using the interior camera **1** and emits a warning if any distraction is detected.

A distraction is when a driver doesn't look at the road for about three seconds or repeats this movement several times in a row.

Note: the system does not record any images and operates in real time.

Location of the camera **1**

Make sure that the camera is not obscured (by dirt, fogging, etc.) or covered.

Operation

 The system continuously monitors the driver's attention and can issue several warnings during a journey.



The function is ready to warn you when the speed is above approximately 12 mph (20 km/h).

In the case of distraction, the "Remain focused on driving" message is displayed on the instrument panel **2** accompanied by a beep.

Press the **3** "OK" switch to clear the warning light displayed on the instru-

ment panel. After deleting the message, the system continues to monitor distraction and issues a new warning if necessary.

Activation/deactivation



For safety reasons, carry out any adjustments while the vehicle is stationary.



Depending on the vehicle, according to the length of time following the last time the engine was stopped, the alerts are reactivated:

- when the vehicle is unlocked;
- or
- when a door is opened;
- or
- when the engine is started.



Depending on the vehicle, it may not be possible to deactivate alerts.

ADDITIONAL DRIVING AID FUNCTIONS

Depending on the vehicle, the alerts can be activated or deactivated using:

- the "My Safety" button;
- the multimedia screen;
- the on-board computer.

3 Activating and deactivating alerts using the "My Safety" button 4



The alerts can be deactivated or activated using "Perso" mode in the "My Safety" → 213.

If the alerts have previously been deactivated using "Perso" mode:

- **to deactivate the alerts**, press the button **4** twice. The indicator light on the button **4** goes out;

- **to reactivate alerts**, press the button **4** once. The indicator light on the button **4** lights up.

Activating and deactivating the alerts from the multimedia screen 5







To activate or deactivate the alerts, please refer to the multimedia instructions.

Select "ON" or "OFF".

Activating and deactivating the alerts from the on-board computer 2



(depending on the vehicle)



- **With the vehicle stationary**, press the switch **6** as many times as required to reach the  tab or, depending on the vehicle, the  tab; or
- press switch **6** and repeatedly press control **7** or **8** to reach the  tab;
- depending on the vehicle, press the "3 OK" switch;
- repeatedly press control **7** or **8** to reach the  menu, then press the "3 OK" switch;

ADDITIONAL DRIVING AID FUNCTIONS

- repeatedly press control **7** or **8** to reach the "DRIVING ASSIST" menu, then press the **3** "OK" switch;
- repeatedly press control **7** or **8** to reach the "Distraction alert" menu, then press the **3** "OK" switch;
- press the **3**"OK" switch again to activate or deactivate the warnings:

-  alerts activated;
-  alerts deactivated.

Limitations of system operation

Some conditions can disrupt or damage the system operation, for example:

- when wearing certain types of glasses;
- if the camera is obstructed, even partially;
- if part of the driver's face is hidden (by hair, a cap, surgical mask, scarf, etc.).
- an unsuitable driving position (such as sitting too low, leaning too far back, etc.) that can prevent the camera from properly analysing the face.

In these conditions, the system may either not trigger a warning or it may trigger untimely or false warnings.

Operating faults

If the system detects an operating fault, the "Vigilance monit. to check" message or, depending on the vehicle, the "Attention monitoring unavailable Face not detected" message appears,

accompanied by the  warning light, on the instrument panel.

Check that the camera is clean and/or remove any face-covering accessories. Make sure you are seated correctly. If there is still a problem, contact an approved Dealer.

Driver fatigue warning

Introduction



This function is an additional driving aid in case of risk of fatigue. The function does not operate on the vehicle. The function cannot, under any circumstances, replace the driver's responsibility during driving.

The driver must always adapt their driving according to their alertness, regardless of the system's indications.



The system analyses the behaviour of the driver's face using the interior camera **1** and emits a warning if there is a risk of the driver falling asleep.

Note: the system does not record any images and operates in real time.

Location of the camera **1**

Make sure that the camera is not obscured (by dirt, fogging, etc.) or covered.

ADDITIONAL DRIVING AID FUNCTIONS

Operation

 The system continuously monitors the driver's attention and can issue several warnings during a journey.

 Every time the engine is started or when changing drivers, the system settings reset after a few minutes.



The function is set to notify the driver if:

- a few minutes have elapsed since the vehicle last stopped;
- the vehicle speed is above approximately 12 mph (20 km/h).

If there is a risk of fatigue, the "Think to have a break" message is displayed on the instrument panel **2** accompanied by a beep.

If the driver falls asleep, the "Fatigue warning Have a break" message is displayed on the instrument panel **2** accompanied by a beep.

It is advisable to stop as soon as possible and take a break.

Press the **3 "OK"** switch to clear the warning displayed on the instrument panel. After the message is deleted, the system continues to monitor fatigue and issues a new warning if necessary

Activation/deactivation



For safety reasons, carry out any adjustments while the vehicle is stationary.

 Depending on the vehicle, according to the length of time following the last time the engine was stopped, the alerts are reactivated:

- when the vehicle is unlocked;
- or
- when a door is opened;
- or
- when the engine is started.

 Depending on the vehicle, it may not be possible to deactivate alerts.

Depending on the vehicle, the warnings can be activated or deactivated using:

- the "My Safety" button;
- the multimedia screen;
- the on-board computer.

ADDITIONAL DRIVING AID FUNCTIONS

Activating, deactivating alerts using the 4 "My Safety" button



The warnings can be deactivated or activated using "Custom" mode in the "My Safety" function → 213.

If the alerts have previously been deactivated using "Custom" mode:

- **to deactivate** the alerts, press the button **4** twice in succession. The indicator light on the button **4** goes out;
- **to reactivate** the alerts, press the button **4** once. The indicator light on the button **4** lights up.

Activating and deactivating the alerts from the multimedia screen 5







To activate or deactivate the alerts, please refer to the multimedia instructions.

Select ON or OFF.

Activating and deactivating the alerts from the on-board computer 2



(depending on the vehicle)



- **With the vehicle stationary**, press the switch **6** as many times as required to reach the  tab or, depending on the vehicle, the  tab; or
- press switch **6** and repeatedly press control **7** or **8** to reach the  tab;
- depending on the vehicle, press switch **3** OK;
- repeatedly press control **7** or **8** to reach the  menu, then press switch **3** OK;
- repeatedly press control **7** or **8** to reach the "DRIVING ASSIST" menu, then press switch **3** OK;

ADDITIONAL DRIVING AID FUNCTIONS

- repeatedly press control **7** or **8** to reach the "Fatigue Alert" menu, then press switch **3** OK;
- press switch **3** OK again to activate or deactivate the warnings:

-  alerts activated;
-  alerts deactivated.

Limitations of system operation

Some conditions can disrupt or damage the system operation, for example:

- when wearing certain types of glasses;
- if the camera is obstructed, even partially;
- if part of the driver's face is hidden (by hair, a cap, surgical mask, scarf, etc.).
- an unsuitable driving position (such as sitting too low, leaning too far back, etc.) that can prevent the camera from properly analysing the face

In these conditions, the system may either not trigger a warning or it may trigger untimely or false warnings.

Operating faults

If the system detects an operating fault, the "Vigilance monit. to check" message or, depending on the vehicle,

the "Attention monitoring unavailable Face not detected" message appears on the instrument panel accompanied

by the  warning light.

Check that the camera is clean and/or remove any face-covering accessories. Make sure you are seated correctly. If there is still a problem, contact an approved Dealer.

Detection of road signs



The system displays speed limits on the instrument panel according to road signs detected on the side of the road.

It mainly uses information taken from the camera **1** attached to the windscreen behind the rear view mirror.

Depending on the country, the system also uses information from a map subscription to interpret certain signs (town entrance, etc.).

The sign displayed on the instrument panel changes when a road sign is detected by the system.

Once the speed limiter or the cruise control is activated, you can adapt the limited speed setpoint to the speed limit displayed on the instrument panel by the system ("Speed limiter" → **251** and "Cruise control" → **254**).

If the detected speed limit is exceeded, the road sign displayed on the instrument panel is modified to inform the driver.

Location of the camera **1**

Make sure the windscreen is not obscured (by dirt, mud, snow, condensation etc.).

Special features

For vehicles with a map subscription:

- if the vehicle is travelling in a country where the speed units differ from those of the vehicle, the system displays the speed limit sign in the unit of the country, alongside the speed limit converted to the unit used by the vehicle's instrument panel.

ADDITIONAL DRIVING AID FUNCTIONS

– for countries where the speed limit is reduced during rainy weather on some types of roads, the system may alter the detected speed limit after a few seconds of the windscreen wipers being activated.

For vehicles without a map subscription: when driving in a country where speed units differ from those on your vehicle, you can manually select the speed unit shown on the instrument panel (e.g. change the unit from miles to kilometres) in order to display accurate information "Displays and indicators" → 124.

Note:

The system does not take into account exceptional speed limit measures, such as peak pollution days.

Operation

Warning lights



The function displays the following warning lights:

2. Speed limit signs and additional speed limit signs (speed on exit ramp with arrow, speed with a caravan, speed limit with length of application, etc.)

3. Additional road signs (start of no overtaking zone).

If the detected speed limit is exceeded, a circle flashes around the road sign (warning light 2) accompanied, depending on the vehicle, by a beep emitted for a few seconds to warn you. It remains illuminated on the instrument panel as long as the vehicle is exceeding the detected speed limit.



ADDITIONAL DRIVING AID FUNCTIONS

i **Map subscription**
Road sign detection is associated with a map subscription.

To manage the subscription, please refer to the multimedia instructions.

If there is no subscription, the system will be limited to taking into account the speed limit signs when they are detected by the camera.

The system will no longer take into account information related to the maps. The speed limit availability may be affected.

Activation/deactivation



For safety reasons, carry out any adjustments while the vehicle is stationary.

i Depending on the vehicle and on the length of time following the last time the engine was stopped, the sound alert is reactivated:

- when the vehicle is unlocked;
- or
- when a door is opened;
- or
- when the engine is restarted.

Activating, deactivating the over-speed sound alert using the 4 "My Safety" button



- **To deactivate the sound alert**, press button **4** twice in succession. The indicator light on button **4** goes out;
- **To reactivate the sound alert**, press button **4** once. The indicator light on button **4** comes on.

Activating, deactivating the over-speed sound alert from the multimedia screen 5



To activate or deactivate the sound alert, please refer to the multimedia instructions.



Select "ON" or "OFF".

ADDITIONAL DRIVING AID FUNCTIONS



Activating, deactivating the over-speed sound alert from the trip computer 6

(depending on the vehicle)



- **With the vehicle stopped**, press the switch 7 as many times as required to reach the  tab;
- or
- press switch 7 and repeatedly press control 8 or 9 to reach the  tab;
- press switch 10 "OK"
- repeatedly press control 8 or 9 to reach the  menu, then press the 10 "OK" switch;

- repeatedly press control 8 or 9 to reach the "DRIVING ASSIST" menu, then press the 10 "OK" switch;
- repeatedly press control 8 or 9 to reach the "Speed alert" menu, then press the 10 "OK" switch;
- press the 10 "OK" switch again to activate or deactivate the sound alert:

-  alert activated;
-  alert deactivated.

Variation of the limited speed or cruising speed



To adapt the speed limiter or cruise control setpoint to the detected speed

limit, press switch 11 (RES/+) or 12 (SET/-).

Temporary unavailability

If the system is unavailable for reasons related to the camera or map data, the



symbol or, depending on the

vehicle, the  symbol is displayed on the instrument panel. If there is still a problem, contact an approved dealer.

The system cannot detect the speed limit if:

- the windscreen is not clean;
- the camera is blinded by the sun;
- there is insufficient visibility (fog, etc.);
- the signs are not legible (snow, etc.) or are hidden (by another vehicle or by trees);
- map information is not up to date.

Note: when the front camera is obscured, the "Front camera no visibility" message appears on the instrument panel. Clean the windscreen area in front of the camera.

Operating faults

When the system detects an operating fault, the  or, depending on the

ADDITIONAL DRIVING AID FUNCTIONS

vehicle,  is displayed on the instrument panel.

In some cases, they are accompanied by the following message:

– « Driving assist unavailable » ;

or

– « Check Front camera » ;

or

– « Check Driving assist ».

Consult an approved Dealer.



This function is an additional driving aid. This function is not under any circumstances intended

to replace the due care and attention of the driver, who should at all times be in control of the vehicle.

The driver must always adapt their speed to the highway code and traffic conditions, regardless of system indications.

The system may not detect all speed limit signs or may interpret them incorrectly.

The driver must not ignore road signs undetected by the system and should give priority to complying with the actual road signs and the highway code.

In the event of poor visibility (fog, snow, frost, etc.), it is possible that the system may not indicate the correct speed to the driver.

SPEED LIMITER



The speed limiter function helps you stay within the driving speed limit that you choose, known as the **limit speed**.

 You can link the speed limiter to the "Road sign detection" function → 246.



The speed limiter function is in no way linked to the braking system.

Controls

1. Speed limiter On/Off switch.
2. Cruise control On/Off switch.
3. Switch to activate and decrease the limit speed (**SET/-**).
4. Switch to activate and increase the limited speed or to recall the stored limited speed (**RES/+**).
5. Switch the function to standby, with limit speed stored (**0**).

Driving

When a limit speed has been set but not yet reached, driving is similar to driving a vehicle without the speed limiter function.

Once you have reached the stored speed, no effort on the accelerator pedal will allow you to exceed the programmed speed except in an emergency (refer to information on "Exceeding the limit speed").

Switching on



SPEED LIMITER

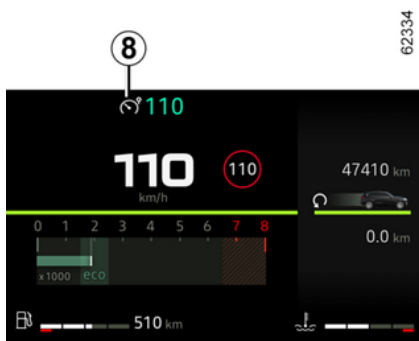

Press the switch **1**. The **6** or **8** warning lights appear in grey or, depending on the vehicle, the **7** warning light appears in orange.

The "**Cruise control ON**" or, depending on the vehicle, the **LIMIT** warning light appears on the instrument panel accompanied by dashes to indicate that the cruise control function is operating and waiting to store a limit speed.

To store the current speed, press switch **4 (RES/+)** or switch **3 (SET/-)**: the limit speed replaces the dashes and, depending on the vehicle, the **6** warning light appears in white.

The minimum speed that can be stored is 19 mph (30 km/h).

Varying the limit speed



The limit speed can be changed by pressing repeatedly or holding down:

- the switch **4 (RES/+)** to increase the speed;
- the switch **3 (SET/-)** to reduce the speed.

Exceeding the limit speed

It is possible to exceed the limit speed at any moment. To do this, press the accelerator pedal **firmly down** beyond the point of resistance.

While the speed is being exceeded, the programmed speed displayed on the instrument panel flashes. Then, release the accelerator pedal: the speed

limiter function will return as soon as you reach a speed lower than the memorised speed.



If the speed limiter is not available (after several attempts to activate), contact an approved dealer.

Limited speed cannot be maintained

When driving down a steep gradient, the system may not maintain the speed limit: the speed limit flashes in red on the instrument panel and an audible signal warns you at regular intervals.

Putting the function on standby

The speed limiter function is suspended when you press switch **5 ((O))**. The limit speed is stored and displayed in grey on the instrument panel.

Recalling the limit speed

If a speed has been stored, it can be recalled by pressing the switch **4**.

SPEED LIMITER

i When the speed limiter is set to standby, pressing switch **3** reactivates the function without taking into account the memorised speed: it is the speed at which the vehicle is moving that is taken into account.

Switching off the function

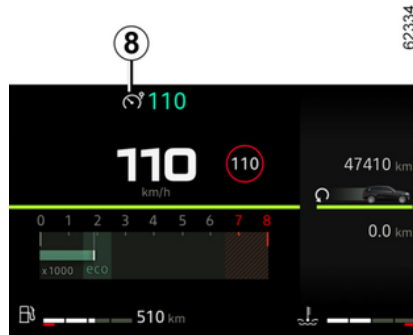
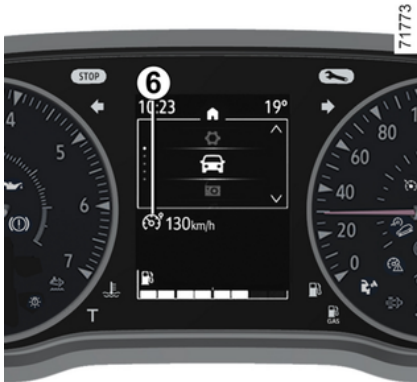

- when you press the **1** switch. In this case, the speed is no longer stored;
- when you press the **2** switch. In this case the cruise control is selected and there is no stored speed.

The orange warning light **7** or, depending on the vehicle, the **6** or **8** warning lights disappears from the instrument panel to confirm that the function is deactivated.

The speed limiter function is interrupted:

CRUISE CONTROL



The cruise control function helps you to maintain your driving speed at a speed that you choose, called the **cruising speed**.

This cruising speed can be set at any speed above 19 mph (30 km/h).



You can link the cruise control function to the "Road sign detection" function

→ 246.



The cruise control function is in no way linked to the braking system.

Controls

1. Cruise control On/Off switch.
2. Switch to activate and decrease cruising speed (**SET/-**).
3. Switch to activate and increase cruising speed or to recall the stored cruising speed (**RES/+**).
4. Put the function on standby (with storage of the cruising speed) (**0**).
5. Speed limiter On/Off switch.



This function is an additional driving aid.

It can under no circumstances replace the

driver's responsibility to respect speed limits or to be vigilant.

The driver must always be in control of the vehicle.

Cruise control must not be used in heavy traffic, on winding or slippery roads (black ice, aquaplaning, gravel) and during bad weather (fog, rain, side winds etc.).

There is a risk of accidents.

CRUISE CONTROL

Switching on

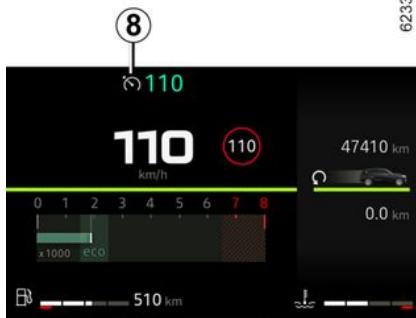

Activating cruise control



3

Press the switch **1**.

The **6** or **8** warning lights appear in grey or, depending on the vehicle, the **7** warning light appears in green.

The "Cruise control ON" or, depending on the vehicle, the **CRUISE** warning light appears on the instrument panel accompanied by dashes to indicate that the cruise control function is activated and waiting to store a cruising speed.

CRUISE CONTROL

3

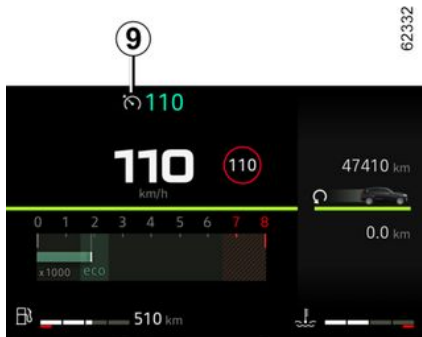

62332

At a steady speed above approximately 19 mph (30 km/h), press switch **2** (SET/-) or switch **3** (RES/+): the function is activated and the current speed is taken into account.

The cruising speed replaces the dashes. Cruise control is confirmed by the appearance in white of the set speed and warning light **6** or, depending

on the vehicle, warning light **8**, **7** or **9** in green in addition to warning light **7**.

Depending on the vehicle, if you try to activate the function below 18 mph (30 km/h), the message "Invalid Speed" is displayed and function remains inactive.

Driving

Once a cruising speed is registered and the cruise control function is active, you may lift your foot off the accelerator pedal.



Please note that you must keep your feet close to the pedals in order to react in an emergency.

Adjusting the cruising speed



71706

The cruising speed can be changed by repeatedly pressing the:

- switch **2** (SET/-) to reduce the speed;
- switch **3** (RES/+) to increase the speed.

Note: press and hold one of the switches to modify the speed by successive increments.

Exceeding the cruising speed

The cruising speed may be exceeded at any time by depressing the accelerator pedal. While it is being exceeded, the cruising speed flashes on the instrument panel.

Then, release the accelerator pedal: after a few seconds, the vehicle will automatically return to its set cruising speed.

Cruising speed cannot be maintained

When driving down a steep gradient, the system is unable to maintain the cruising speed: the memorised speed will flash on the instrument panel.



If the cruise control is no longer available (after several attempts to activate it), contact an Approved Dealer.

CRUISE CONTROL



Cruise control with cruising speed maintained during gear changing:

This function maintains the cruise control speed before and after a gear change, without any action required from the driver.

Putting the function on standby

The function is set to standby if you:

- press the switch **4 (O)**;
- press the brake pedal;
- press the clutch pedal for a prolonged period or if the vehicle is in neutral for a prolonged period on vehicles equipped with a manual gearbox;
- shift to neutral position on vehicles equipped with an automatic gearbox.

The cruising speed is stored and displayed in grey on the instrument panel.



Depending on the vehicle, the warning light **8** disappears to confirm standby.

Returning to the cruising speed

If a speed is stored, it can be recalled, once you are sure that the road conditions are suitable (traffic, road surface, weather conditions, etc.). Press switch **3 (RES/+)** if the vehicle speed is above 19 mph (30 km/h).



When the stored speed is recalled, the activation of cruise control is confirmed by the display in white of the cruising speed and, depending on the vehicle, the **8** or **9** warning light.

Note: if the speed previously stored is much higher than the current speed, the vehicle will accelerate more rapidly to reach this threshold.

When the cruise control function is on standby, pressing the switch **2 (SET/-)** to reactivate the cruise control function without taking into account the stored speed: the speed at which the vehicle is moving will be taken into account.

CRUISE CONTROL

Switching off the function



The cruise control function is interrupted:

- when you press the **1** switch. In this case, the speed is no longer stored;
- when you press the **5** switch. In this case the speed limiter is selected and there is no stored speed.

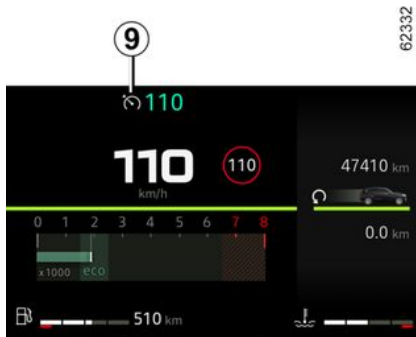

The green **7** warning light or, depending on the vehicle, the **6** or **9** warning light disappears from the instrument panel to confirm that the function is deactivated.



Putting the cruise control on standby or switching it off does not cause a rapid reduction in speed: you must brake by pressing the brake pedal.

PARKING AIDS

Reversing camera

Operation



When reverse gear is engaged, the camera **1** located at the rear of the vehicle transmits a view of the area behind the vehicle to the multimedia display **2** accompanied by three guide lines **3**, **4** or **5** (fixed, moving and trailer guide lines).

This system uses several guidelines for its operation (mobile for trajectory and fixed for distance). When the red zone is reached, use the bumper image to stop accurately.



Fixed guide lines **3**

The fixed gauge includes coloured markers **A**, **B** and **C** indicating the distance behind the vehicle:

- **A** (red) at approximately 30 centimetres from the vehicle;
- **B** (yellow) at approximately 70 centimetres from the vehicle;
- **C** (green) at approximately 150 centimetres from the vehicle.

This gauge remains fixed and indicates the vehicle trajectory if the wheels are in line with the vehicle.

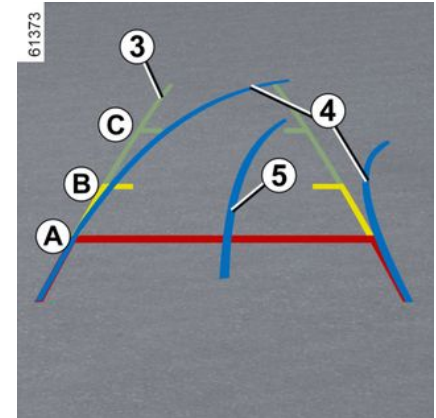

Moving guide line **4**

This is shown in blue on the multimedia screen **2**. It indicates the vehicle trajectory according to the position of the steering wheel.

Trailer guide lines **5**

This is shown in blue on the multimedia screen **2**. This indicates the trajectory of the trailer towbar according to the steering wheel position. It allows the driver to position the towbar as close as possible to the trailer's towing head.

« Trailer view »

If a trailer is connected, while in a forward gear press the "Camera" menu in the "Vehicle" world on your multimedia screen **2** to enable the camera **1** to

PARKING AIDS

transmit a view of the rear environment during approximately 30 seconds.

Special feature

Make sure that the camera is not obscured (by dirt, mud, snow, condensation etc.).

Settings



Vehicle stationary, engine on, from the multimedia screen **2**, you can add or remove the guides and adjust the camera image settings (brightness, contrast etc.). Please refer to the multimedia instructions for further information.

"Zoom auto" function

If an obstacle is detected behind the vehicle, the function "Zoom auto" switches the current display to a top rear view.

To activate/deactivate the "Zoom auto" function, please see the multimedia user manual.



The screen shows a reverse mirror image.

The frames are a representation projected on a flat surface. This information is to not be taken into account when superimposed on a vertical object or an object on the ground.

Objects which appear on the edge of the screen may be deformed.

In very bright light (snow, vehicle in sunshine, etc.), the camera vision may be adversely affected.

If the luggage compartment is open or incorrectly closed, the "WARNING: Boot Open" message appears on the multimedia screen.

Deactivating the system

The system may be deactivated:

- when the vehicle is travelling faster than approximately 6 mph (10 km/h);
- shortly after disengaging reverse gear.

Operating faults

When reverse gear is engaged, if the system detects an operating fault, a black screen is displayed temporarily on the multimedia screen **2**.

This may be caused by a fault affecting the camera or screen (clearness, fixed image, delayed communication etc.).

If the temporary display of the black screen persists, please consult an approved dealer.

PARKING AIDS



This function is an additional aid. It cannot, therefore, under any circumstances replace the vigilance or the responsibility of the driver.

The driver should always be ready for sudden incidents while driving: always ensure that there are no small, narrow moving obstacles (such as a child, animal, pushchair, bicycle, stone, post, etc.) in the blind spot when manoeuvring.

Difference between the estimated distance and actual distance

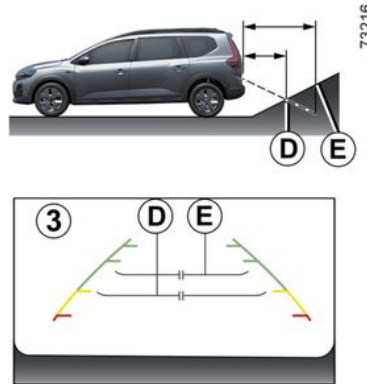

Reversing towards a steep uphill slope

The fixed guidelines **3** show the distances as closer than they actually are.

The objects shown on the screen are actually further away on the slope.

For example, if the screen displays an object at **D**, the actual distance of the object is at **E**.

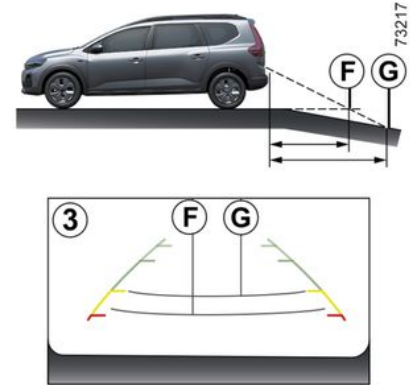

Reversing towards a steep downhill slope

The fixed guidelines **3** show the distances as further than they actually are.

Therefore, the objects shown on the screen are actually closer on the slope.

For example, if the screen displays an object at **G**, the actual distance of the object is at **F**.

PARKING AIDS

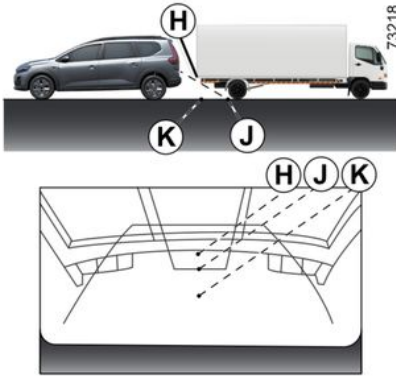

Reversing towards a protruding object

Position **H** seems further than position **J** on the screen. However, position **H** is at the same distance as position **K**.

The trajectory indicated by the fixed and mobile guidelines do not take into account the height of the object. So there is a risk that the vehicle may collide with the object when reversing towards position **K**.

Multi-view camera

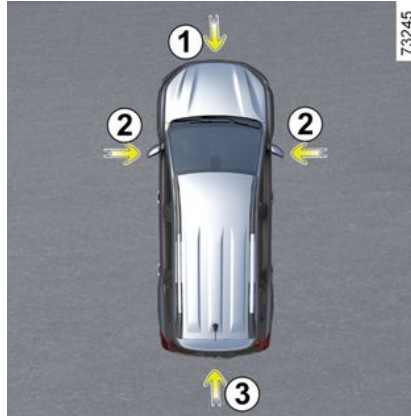

If fitted on the vehicle, the four cameras **1**, **2** and **3** located in the front bumper, door mirrors and tailgate help you with difficult manoeuvres.



The cameras transmit four separate views to the screen **4**, making it possible to view the area around the vehicle.

Note: make sure that the cameras are not obscured (by dirt, mud, snow, condensation, etc.).

PARKING AIDS



This function is an additional aid. It cannot, therefore, under any circumstances replace the vigilance or the responsibility of the driver.

The driver should always be ready for sudden incidents while driving: always ensure that there are no small, narrow moving obstacles (such as a child, animal, pushchair, bicycle, stone, post, etc.) in the blind spot when manoeuvring.

Activating the system

With the ignition on, the system may be activated:

- in automatic mode, when changing into reverse gear: the system is activated and the camera located on the tailgate transmits a view of the area behind the vehicle onto the screen **4**;
- in manual mode, with the vehicle stationary and the engine on, from the "Vehicle" world on your multimedia screen **4**, press the "360° Camera" menu and the front view will appear on the multimedia screen.

Note: depending on the vehicle, certain settings can be adjusted from the screen **4**. Refer to the multimedia instructions.

Automatic mode



Automatic mode is activated when reverse gear is engaged and the screen **4** shows the rear camera view. When there is a quick change from reverse gear to forward gear, the screen **4** shows the image transmitted from the front camera.

Automatic mode is deactivated:

- by selecting another camera view from the menu on the screen **4**;
- automatically as soon as you reach about 7 mph (12 km/h);

- shortly after disengaging reverse gear.

Manual mode

To activate it, select the desired camera view from the menu on the screen **4**.

A message appears on the screen **4** for approximately five seconds to confirm the activation of manual mode.

Manual mode is deactivated:

- automatically as soon as you reach approximately 6 mph (10 km/h);
- around 3 minutes after disengaging reverse gear, in manual mode;
- by pressing the "Back" button after disengaging reverse, in manual mode.

PARKING AIDS

Reversing camera 3



If the rear camera is activated automatically or manually, the view from the camera is displayed on the screen 4.

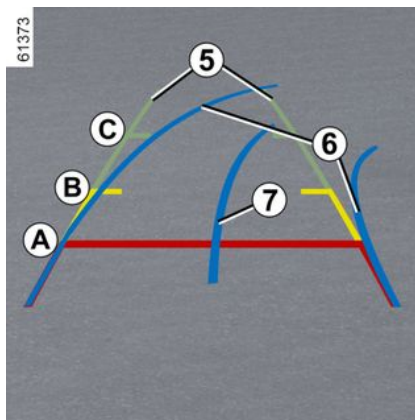

Fixed guide lines 5

The fixed gauge includes coloured markers **A**, **B** and **C** indicating the distance behind the vehicle:

- **A** (red) at approximately 30 centimetres from the vehicle;
- **B** (yellow) at approximately 70 centimetres from the vehicle;
- **C** (green) at approximately 150 centimetres from the vehicle.



The image displayed on the multimedia screen may seem faster than reality.

Moving guide line 6

(depending on the vehicle)

This is shown in blue on the multimedia screen 4. It indicates the vehicle trajectory according to the position of the steering wheel.

Trailer guide lines 7

This is shown in blue on the multimedia screen 4. This indicates the trajectory of the trailer towbar according to the steering wheel position. It allows the driver to position the towbar as close as possible to the trailer's towing head.

« Trailer view »

If a trailer is connected, while in a forward gear press the "Camera" menu in the "Vehicle" world on your multimedia screen 4 to enable the camera 3 to transmit a view of the rear environment during approximately 30 seconds.

"Zoom auto" function

If an obstacle is detected behind the vehicle, the function "Zoom auto" switches the current display to a top rear view.

To activate/deactivate the "Zoom auto" function, please see the multimedia user manual.

PARKING AIDS



The screen shows a reverse mirror image.

The frames are a representation projected on a flat surface. This information is to not be taken into account when superimposed on a vertical object or an object on the ground.

Objects which appear on the edge of the screen may be deformed.

In very bright light (snow, vehicle in sunshine, etc.), the camera vision may be adversely affected.

If the luggage compartment is open or incorrectly closed, the "Tailgate open" message appears.

Front camera 1



If the front camera is activated automatically or manually, the view from the camera is displayed on the screen **4**.

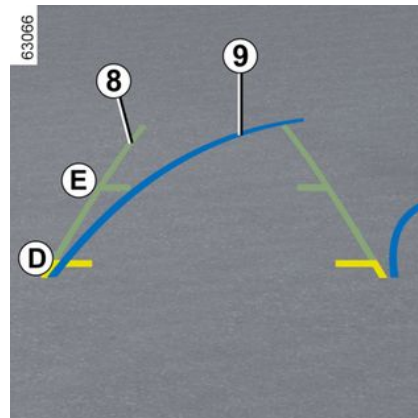

Fixed guide lines 8

The fixed guide line comprises coloured markers **D** and **E** indicating the distance in front of the vehicle:

- **D** (yellow) at approximately 70 centimetres from the vehicle;
- **E** (green) at approximately 150 centimetres from the vehicle.



The image displayed on the multimedia screen may seem faster than reality.

PARKING AIDS

Moving guide line 9

(depending on the vehicle)

This is shown in blue on the multimedia screen 4. It indicates the vehicle trajectory according to the position of the steering wheel.

"Zoom auto" function

If an obstacle is detected in front of the vehicle, the function "Zoom auto" switches the current display to a top front view.

To activate/deactivate the "Zoom auto" function, refer to the multimedia instructions.



The screen shows a reverse mirror image.

The frames are a representation projected on a flat surface. This information is to not be taken into account when superimposed on a vertical object or an object on the ground.

Objects which appear on the edge of the screen may be deformed.

In very bright light (snow, vehicle in sunshine, etc.), the camera vision may be adversely affected.

If the luggage compartment is open or incorrectly closed, the "Tailgate open" message appears.

Side cameras 2



The cameras 2 installed in the door mirrors transmit the side views to the screen 4.

To activate the desired camera view, select it on the screen 4. See the multimedia equipment instructions for further information.

PARKING AIDS

Difference between the estimated distance and actual distance

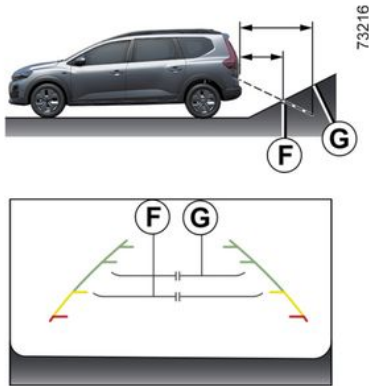

Driving or reversing towards a steep uphill slope

The fixed guidelines **5** show the distances as closer than they actually are. The objects shown on the screen are actually further away on the slope.

For example, if the screen displays an object at **F**, the actual distance of the object is at **G**.

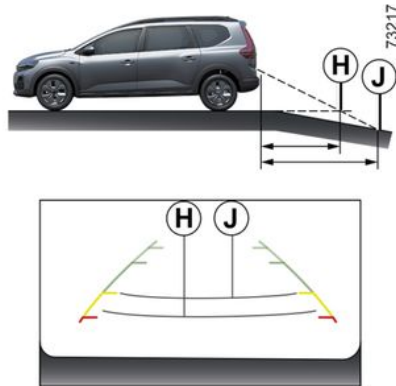

Driving or reversing towards a steep downhill slope

The fixed guidelines **5** show the distances as further than they actually are.

Therefore, the objects shown on the screen are actually closer on the slope.

For example, if the screen displays an object at **J**, the actual distance of the object is at **H**.

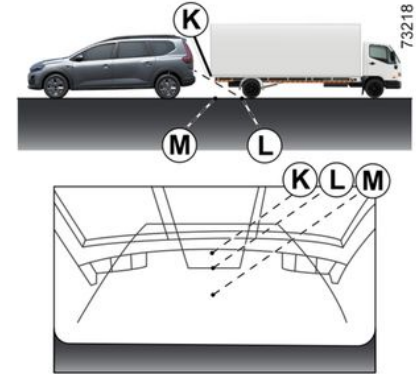

Driving or reversing towards a protruding object

Position **K** seems further than position **L** on the screen. However, position **K** is at the same distance as position **M**.

The trajectory indicated by the fixed and mobile guidelines do not take into account the height of the object. So there is a risk that the vehicle may collide with the object when reversing towards position **M**.

PARKING AIDS

Parking Distance Control

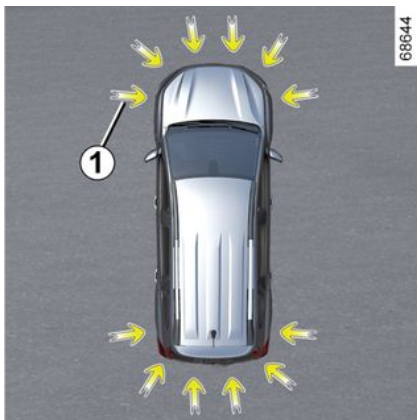

Ultrasonic sensors, indicated by arrows **1**, are fitted in the bumpers to detect obstacles near the vehicle.

The function alerts the driver via audible signals and, depending on the vehicle, a display representing the area where the obstacle was detected.

Depending on the equipment, the system detects obstacles behind, in front and to the sides of the vehicle.

The parking distance control system is only activated when the vehicle is driven at a speed below approximately 6 mph (10 km/h).

The function does not take into account towing or carrying systems that are not recognised by the system.



This function is an additional driving aid.

Under no circumstances should it replace the driver's care or responsibility whilst reversing.

The driver should always be ready for sudden incidents while driving: always ensure that there are no small, narrow moving obstacles (such as a child, animal, pushchair, bicycle, stone, post, etc.) in the blind spot when manoeuvring.



An impact to the underside of the vehicle while manoeuvring (e.g. striking a post, raised kerb or other street furniture) may result in damage to the vehicle (e.g. deformation of an axle). To avoid any risk of accident, have your vehicle checked by an approved Dealer.

Location of the ultrasonic sensors **1**

Ensure that the area around the ultrasonic sensors indicated by the arrows **1** is not obscured (by dirt, mud, snow, a badly fitted/attached number plate), impacted, modified (including paintwork) or obstructed by any accessory fitted to the rear and/or, depending on the vehicle, to the front of your vehicle.

PARKING AIDS

Operation



Depending on the vehicle, the display **2** shows the vehicle surroundings alongside the beeps.

Obstacle detection

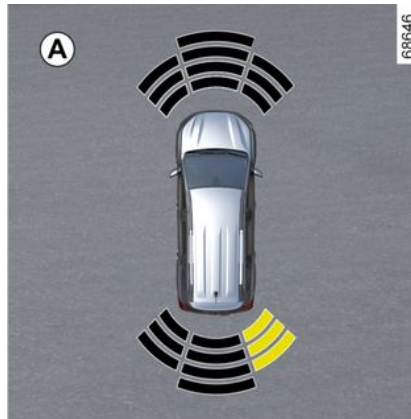

The system is able to detect most obstacles located near the rear and, depending on the equipment, near the front and sides of the vehicle.

The audible signal frequency will increase as the vehicle approaches an obstacle, until it becomes a solid beep at approximately 20 cm for an obstacle detected on the sides and approximately 30 cm for an obstacle detected to the front or rear.

Depending on the vehicle, the area where the obstacle has been detected is shown (display **A**). Depending on the vehicle, the area is displayed in green, orange (or yellow depending on

the vehicle) or red, depending on the proximity of the detected obstacle.

i In the event of a change in trajectory during a manoeuvre, the risk of collision with an obstacle may be signalled late.

Activation/deactivation

Activating, deactivating the system from the multimedia screen **3**



From "Vehicle" mode on your multimedia screen **3**, press the "PARKING ASSIST" menu.

PARKING AIDS

Activate or deactivate areas covered by the ultrasonic detectors.

Please refer to the multimedia instructions for further information.

Note: depending on the vehicle, the rear detection zone cannot be deactivated.

Activating, deactivating the system from the on-board computer 4

(depending on the vehicle)



– **With the vehicle stationary**, press the switch **5** as many times as re-

quired to reach the  tab; or

– press switch **5** and repeatedly press

control **6** or **7** to reach the  tab;

– press the **8** "OK" switch

– repeatedly press control **6** or **7** to

reach the  menu, then press the **8** "OK" switch;

– repeatedly press control **6** or **7** to reach the "DRIVING ASSIST" menu, then press the **8** "OK" switch;

– repeatedly press control **6** or **7** to reach the "Parking" menu, then press the **8** "OK" switch;

– press switch **8** "OK" again to activate or deactivate the function:

–  function activated;

–  function deactivated.

Note: depending on the vehicle, the "rear" detection zone cannot be deactivated.

Parking distance control automatic deactivation

The system is deactivated:

– when the vehicle speed is above approximately 6 mph (10 km/h);

– depending on the vehicle, when the vehicle is stationary for more than approximately five seconds and an obstacle is detected (such as when in a traffic jam, etc.);

– when the vehicle is in neutral for a manual gearbox or in position **N** or **P** for automatic gearboxes;

– when an operating fault is detected.

Note: depending on the vehicle, if the vehicle is fitted with a towbar recognised by the system, only the rear Park Assist function is deactivated.

Adjustment



For safety reasons, carry out any adjustments while the vehicle is stationary.



Each time the vehicle is started, the function continues the mode saved the last time the engine was stopped.

Settings from the multimedia screen 3

PARKING AIDS



With the vehicle stationary, from the "Vehicle" world on the your multimedia screen **3**, press the "Parking assistance" menu.

Please refer to the multimedia instructions for further information.

Settings from the on-board computer **4**

(depending on the vehicle)



– **With the vehicle stationary**, press switch **5** as many times as required to

reach the  tab;

or

– press control **5** and repeatedly press

control **6** or **7** to reach the  tab;

– depending on the vehicle, press the **8** "OK" switch

– repeatedly press control **6** or **7** to

reach the  menu, then press the switch **8** "OK";

– repeatedly press control **6** or **7** to reach the "DRIVING ASSIST" menu, then press switch **8** "OK";

– repeatedly press control **6** or **7** to reach the "Parking" menu, then press the **8** "OK" switch;

– repeatedly press control **6** or **7** to select the setting, then press the **8** "OK" switch.

Deactivating the system sound (depending on the vehicle)

Activate or deactivate the parking distance control sound.

Note: if you mute the sound, when approaching an obstacle you will be alerted only by the display.

Parking distance control audio volume

Adjust the Park Assist volume using the volume bar.

 Each time the vehicle is started, the function continues the mode saved the last time the engine was stopped.

Special cases

You can manually deactivate sound alerts or, depending on the vehicle, the detection zone concerned in the event that:

– towing, carrying or trailer equipment that is unrecognised by the system is

PARKING AIDS

present in front of the ultrasonic sensors;

- the ultrasonic sensors are damaged.

Note: even if the sound is muted, the displays will continue to warn you.

3

Operating faults

When the system detects an operating fault:

- either a beep sounds for approximately three seconds when the reverse gear is engaged, accompanied by the "Check Parking sensors" message on the instrument panel;
- or the system does not produce any sound (unless deliberately deactivated) or there is no display when the reverse gear is engaged.

Check that your ultrasonic sensors are clean. If the fault persists, consult an approved Dealer.



When the vehicle is travelling at a speed below approximately 6 mph (10 km/h), some noises (motorcycle, lorry, pneumatic drill, etc.) may trigger the Park Assist system audible warnings.

PARKING AIDS

Advice



System servicing/repairs

- In the event of an impact, the alignment of the ultrasonic sensors may be altered and its operation may consequently be affected. Deactivate the function and consult an authorised dealer.
- Any work in the area where the ultrasonic sensors are located (repairs, replacements etc.) must be carried out by a qualified professional.

Only an authorised dealer is qualified to service the system.

System disturbance

Some conditions can disrupt or damage the system operation, for example:

- poor weather conditions (rain, snow, hail, black ice, etc.);
- some types of noise (motorcycle, lorry, pneumatic drill, etc.);
- fitting an non-compatible towing ball or hook.

Risk of false alarms or absence of warnings

If the system behaves abnormally contact an authorised dealer.

Limitation of the system operation

- The ultrasonic detection zones should be kept clean and free of any modifications in order to ensure the proper operation of the system.
- Small objects moving close to the vehicle (motorcycles, bicycles, pedestrians, etc.) may not be recognised by the system.
- The system may not detect obstacles that are too close to the vehicle.
- The system may not provide a warning when the other vehicles or obstacles are travelling at a significantly different speed.
- When there is a change in trajectory during a manoeuvre, the system may be slow in reporting obstacles.

EMERGENCY CALL

If the vehicle is equipped, the emergency call function can be used to call the emergency services (without charge) automatically or manually in the event of an accident or illness, reducing the time it takes for the emergency services to arrive.

Note: the emergency call function is operational:

- in countries covered by 2G and 3G or, depending on the vehicle, 4G telecommunication infrastructure and associated telematic emergency services that are compatible with the system;
- depending on the network coverage in the geographical region where the vehicle is being driven.

If you use the emergency call function to report an accident which you have witnessed, this implies stopping where traffic conditions allow to allow the emergency services to locate your vehicle and therefore the location of the reported accident.

In all cases, comply with local legislation.

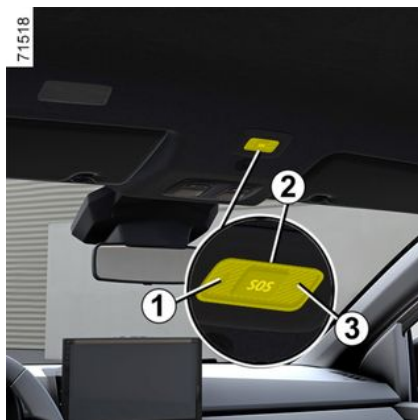

1. System operation warning light:

- green: operational (e.g. system and network available);
- off: non-operational (e.g. network unavailable);
- red: operational fault
- flashing green: call in progress.

2. SOS button;

3. Microphone;

4. Speaker.



Use the emergency call only in the event of an emergency you are involved in, if you witness an accident or if you feel ill.



In the event of an accident, if the location and traffic conditions permit, stay close to the vehicle in order to be able answer the call centre quickly if necessary.

EMERGENCY CALL

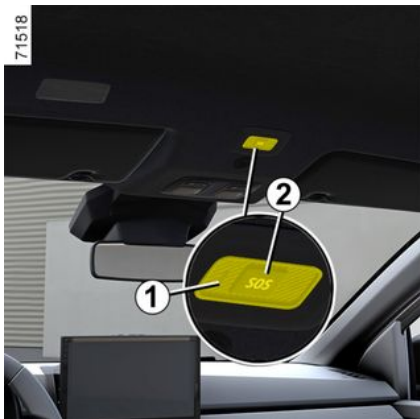

A call always takes place as follows:

- the call is initiated with the emergency services;
- data related to the incident (manufacturer's plate, time of the call, last locations, vehicle direction, etc.) is sent;
- voice communication takes place with the emergency services;
- if necessary, emergency assistance is called.

There are two emergency call modes:

- automatic mode;
- manual mode.

Automatic mode

When the system is operational, automatic mode is activated.

The emergency call starts automatically in the event of an accident that has required the activation of the protective equipment (seat belt pretensioners, airbag etc.).

Manual mode

The emergency call can be initiated by:

- pressing and holding the button **2** for at least 3 seconds;
- or
- pressing the button **2** five times within 10 seconds.

If the button was pressed by mistake, it is possible to cancel the call by pressing and holding the button **2** for around two seconds, before the call is connected to the call centre.

Once a call is established, only the call centre can end it.

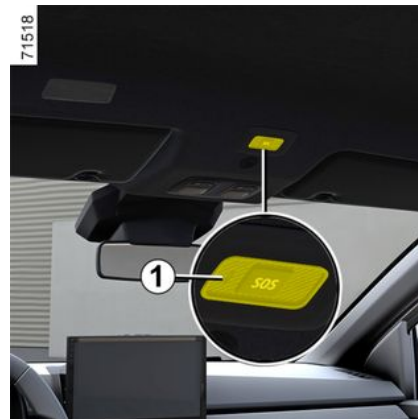

Operating faults

In some cases, the emergency call may not work (e.g. low battery, etc.).

When the system detects an operating fault, the warning light **1** appears in red for over 30 minutes. Consult an approved Dealer as soon as possible.

 The system operates with a dedicated battery. The battery service life is approximately 4 years (the **1** warning light lights up in red to inform you). Consult an approved Dealer.

EMERGENCY CALL



To guarantee your safety and the proper operation of the system, any operation carried out on the battery (removal, disconnection, etc.) must be carried out by a qualified specialist.

Risk of serious burns from electric shocks.

You must respect the replacement intervals (without exceeding them) as stated in the maintenance document.

The battery is a specific type.

Please ensure it is replaced with the same type.

Call an approved Dealer.



Without the emergency call feature, the system is not trackable and will not be under constant surveillance. Data is automatically and constantly erased, and the system stores only the last three positions of the vehicle.

Data is only sent in the event of an emergency call. Data sent to the call centre is treated according to the personal data protection laws applicable in the country where you are located. The system stores activity history data for 13 hours only.

The vehicle owner has the right of access to their data. They can request that the data be corrected, deleted or locked.

AIR VENTS, HEATING AND AIR CONDITIONING

Air vents: air outlets

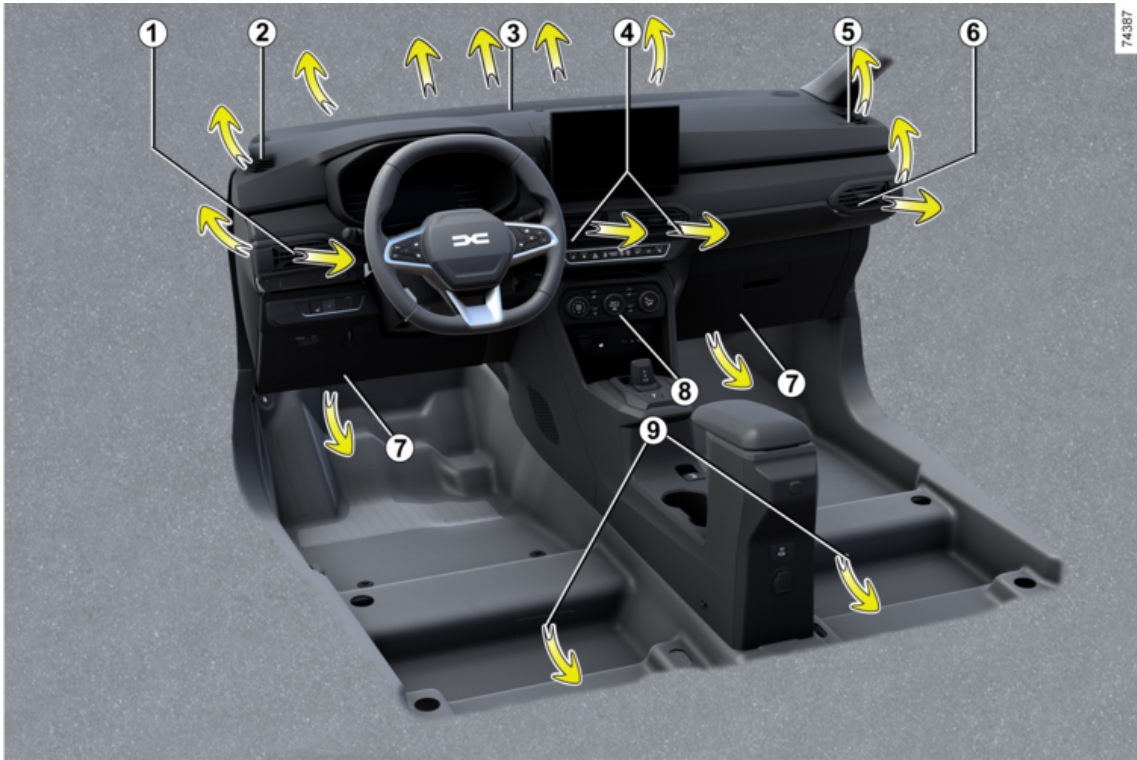

4

AIR VENTS, HEATING AND AIR CONDITIONING

- 1** Left-hand air vent
- 2** Left-hand side window demisting vent
- 3** Windscreen demisting vents
- 4** Centre air vents
- 5** Right-hand side window demister outlet
- 6** Right-hand air vent
- 7** Footwell heater outlets for front occupants
- 8** Control panel
- 9** Footwell heater outlets for rear passengers (depending on the vehicle)

AIR VENTS, HEATING AND AIR CONDITIONING

Centre 4 and side 1 and 6 air vents



Air flow

Air vent 1

To open: move the cursor **10** to the right.

To close: move the cursor **10** to the left, as far as it will go.

Air vent 6

To open: move the cursor **10** to the left.

To close: move the cursor **10** to the right, as far as it will go.

Direction

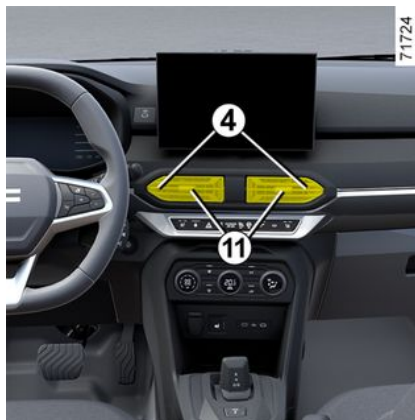

Air vents 4

Move the cursor **11** to the desired position.



Do not add anything to the vehicle's ventilation circuit (for example, to remove bad odours).

There is a risk of damage or of fire.

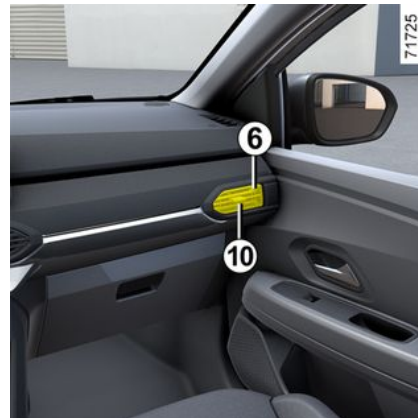

Do not attach any objects to the air vents (e.g. telephone mounting).

Risk of damage.



To remove bad odours from your vehicles, only use the systems designed for this purpose. Consult an approved Dealer.

Rear seats

(depending on the vehicle)

AIR VENTS, HEATING AND AIR CONDITIONING



Footwell heater outlets for occupants **12**.



Do not add anything to the vehicle's ventilation circuit (for example, to remove bad odours).

There is a risk of damage or of fire.

Manual air conditioning, heating system

System A

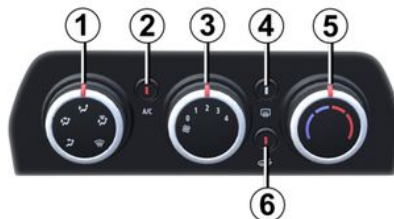

Controls

The controls will depend on the vehicle equipment level.

1. Distribution of air.
2. Switching air conditioning on or off.
3. Adjusting the ventilation fan speed.
4. De-icing/demisting of the rear screen and, depending on the vehicle, the rear view mirrors.
5. Adjusting the air temperature.

6. Switching passenger compartment isolation mode/air recirculation mode on

Information and advice for use
→ 288.

Adjusting the air temperature

Turn control **5** to obtain the desired temperature. The further towards the red the slide is, the higher the temperature will be.

Adjusting the ventilation fan speed

Move control **3** from 0 to 4. The further the control is positioned to the right, the greater the amount of air blown into the passenger compartment. To stop air from entering the passenger compartment, set the **3** control to "0".

The system is deactivated: the ventilation speed for the passenger compartment air is zero (vehicle stationary), you can however still feel a slight flow of air when the vehicle is moving.

AIR VENTS, HEATING AND AIR CONDITIONING

i Prolonged use of this control in position 0 can lead to condensation forming on the side windows and windscreen and problems due to the use of non-renewed air in the passenger compartment.

Switching passenger compartment isolation mode/air recirculation mode on.



67957

A warning light illuminates on the **6** button to confirm its operation.

Under these conditions, air is taken from the passenger compartment and

is recirculated, with no air being taken from outside the vehicle.

i Prolonged use of air recirculation can lead to condensation forming on the side windows and windscreen and discomfort due to the lack of fresh air in the passenger compartment. We therefore advise you to return to normal mode (external air) as soon as the air recirculation function is no longer required, by pressing the **6** button.

Air recirculation operates as follows:

- isolating the vehicle from the external atmosphere (e.g. when driving in polluted areas, etc.);
- to bring the passenger compartment to the desired temperature as quickly as possible.

Rapid demisting

Turn controls **1**, **3** and **6** to positions:

- demisting ;
- maximum fan speed;
- external air.

Using the heating and air conditioning system increases the speed of demisting.

Heated rear screen



With the engine running, press the button **4** (the warning light comes on).

This function de-ices/demists the rear screen and the electric de-icing rear-view mirrors (depending on the vehicle).

Depending on the vehicle, the function is stopped:

- after a period of time set by the system (the indicator light disappears);
- by pressing button **4** again (the indicator light disappears).

AIR VENTS, HEATING AND AIR CONDITIONING

Distribution of air in the passenger compartment

67957



Turn control **1** to choose the distribution option.



The air flow is directed to the dashboard vents.



The air flow is directed towards the dashboard vents and the footwells.



The air flow comes mainly through the vents located at the occupants' feet (underneath the dashboard and/or underneath the front seats).



The air flow is distributed between front side window demisting vents, the windscreen demisting vents and the footwells.



All the air is then directed to the windscreen and front side window demisting vents.

Switching the air conditioning on or off

The air conditioning is switched on (indicator light lit) or off (indicator light off) using button **2**

Activation is not possible if the **3** control is set to 0.

The air conditioning system is used for:

- lowering the temperature inside the passenger compartment;
- eliminating condensation more quickly.

The air conditioning does not operate when the exterior temperature is low.



Fuel consumption increases when the air conditioning is being used (switch it off when it is not required).

System B

67958

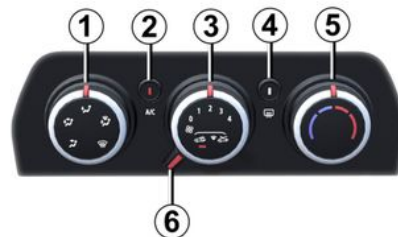

4

Controls

The controls will depend on the vehicle equipment level.

1. Distribution of air.
2. Switching air conditioning on or off.
3. Adjusting the ventilation fan speed.
4. De-icing/demisting of the rear screen and, depending on the vehicle, the rear view mirrors.
5. Adjusting the air temperature.
6. Switching passenger compartment isolation mode/air recirculation mode on

AIR VENTS, HEATING AND AIR CONDITIONING

Information and advice for use
→ 288.

Adjusting the air temperature

Turn control **5** to obtain the desired temperature. The further towards the red the slide is, the higher the temperature will be.

Adjusting the ventilation fan speed

Move control **3** from 0 to 4. The further the control is positioned to the right, the greater the amount of air blown into the passenger compartment. To stop air from entering the passenger compartment, set the **3** control to "0".

The system is deactivated: the ventilation speed for the passenger compartment air is zero (vehicle stationary), you can however still feel a slight flow of air when the vehicle is moving.

i Prolonged use of this control in position 0 can lead to condensation forming on the side windows and windscreen and problems due to the use of non-renewed air in the passenger compartment.

Switching passenger compartment isolation mode/air recirculation mode on.

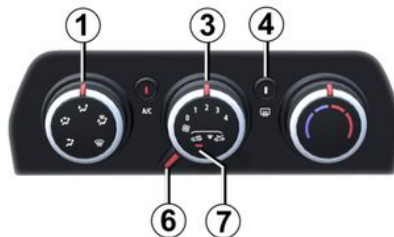

A warning light **7** lights up to confirm operation.

Under these conditions, air is taken from the passenger compartment and is recirculated, with no air being taken from outside the vehicle.

i Prolonged use of air recirculation can lead to condensation forming on the side windows and windscreen and discomfort due to the lack of fresh air in the passenger compartment. You are therefore advised to return to normal mode (external air) as soon as the air recirculation function is no longer required, by turning control **6** to the right.

Air recirculation operates as follows:

- isolating the vehicle from the external atmosphere (e.g. when driving in polluted areas, etc.);
- to bring the passenger compartment to the desired temperature as quickly as possible.

Rapid demisting

Turn controls **1**, **3** and **6** to positions:

- demisting ;
- maximum fan speed;
- external air.

Using the air conditioning increases the speed of demisting.

AIR VENTS, HEATING AND AIR CONDITIONING

Heated rear screen



With the engine running, press the button **4** (the warning light comes on).

Depending on the vehicle, this function de-ices/demists the rear screen and the exterior rearview mirrors.

Depending on the vehicle, the function is stopped:

- after a period of time set by the system (the indicator light disappears);
- by pressing button **4** again (the indicator light disappears).

Distribution of air in the passenger compartment

67958



Turn control **1** to choose the distribution option.



The air flow is directed to the dashboard vents.



The air flow is directed towards the dashboard vents and the footwells.



The air flow comes mainly through the vents located at the occupants' feet (underneath the dashboard and/or underneath the front seats).



The air flow is distributed between front side window demisting vents, the windscreen demisting vents and the footwells.



All the air is then directed to the windscreen and front side window demisting vents.

Switching the air conditioning on or off

The air conditioning is switched on (indicator light lit) or off (indicator light off) using button **2**

Activation is not possible if the **3** control is set to 0.

The air conditioning system is used for:

- lowering the temperature inside the passenger compartment;
- eliminating condensation more quickly.

The air conditioning does not operate when the exterior temperature is low.



Fuel consumption increases when the air conditioning is being used (switch it off when it is not required).

4

Automatic climate control

The controls

67959



AIR VENTS, HEATING AND AIR CONDITIONING

(depending on the vehicle)

1. Adjusting the ventilation fan speed.
2. "Clear View" function.
3. Adjusting the air temperature.
4. Switching air conditioning on or off.
5. Passenger compartment air distribution adjustment.
6. Air distribution mode display.
7. Switching passenger compartment isolation mode/air recirculation mode on
8. Automatic mode.
9. Temperature display.
10. De-icing/demisting of the rear screen and, depending on the vehicle, the rear view mirrors.
11. Ventilation speed display.

Automatic mode

The automatic climate control system guarantees comfort in the passenger compartment and good visibility (except in the event of extreme conditions), whilst optimising consumption. The system controls the ventilation speed, air distribution, air recirculation, and starting and stopping the air conditioning and air temperature.

AUTO: optimises the selected comfort level according to exterior conditions.

Press the button **8**. The integrated indicator light on button **8** comes on.

Adjusting the ventilation fan speed



In automatic mode, the system uses the most suitable amount of air to reach and maintain the desired comfort level.

You can still adjust the ventilation speed by turning control **1** to increase or reduce the ventilation speed.

Adjusting the air temperature

Turn control **3** to obtain the desired temperature.

Special feature: the highest and lowest settings allow the system to pro-

duce maximum hot or cold temperature levels ("Lo" and "Hi").

 The displayed temperature values show a comfort level.

When the vehicle is started, increasing or decreasing the value displayed does not mean that the temperature reaches comfort level more quickly. The system still optimises the decrease or the increase in temperature (the ventilation will not start at maximum speed immediately: it increases gradually). It may take from a few seconds to several minutes. Generally speaking, unless there is a particular fault, the dashboard air vents should remain open.

"Clear View" function

Press button **2**, the indicator light above comes on.

This function quickly demists and defices the windscreen, the rear screen, the front side windows, and the exterior or rear view mirrors (depending on the vehicle). It automatically activates the

67959

AIR VENTS, HEATING AND AIR CONDITIONING

air conditioning and rear screen de-icing functions.

Note: it automatically deactivates air recirculation.

Press button **2** to stop the heated rear screen operating. The indicator light above goes out.

To exit this function, press button **2** or **8** or adjust the ventilation speed by turning control **1**.

Adjusting the distribution of air in the passenger compartment





67959

Turn the control **5** according to the distribution of air required. The integrated warning light in the button comes on.

It is possible to combine two positions at the same time.

 The air flow is then directed to the windscreen and front side window demisting vents.

 The air flow is distributed between front side window demisting vents, the windscreen demisting vents and the footwells.

 The air flow comes mainly through the vents located at the occupants' feet (underneath the dashboard and/or underneath the front seats).

 The air flow is directed towards the dashboard vents and the footwells.

 The air flow is directed to the dashboard air vents and the central vents for the rear passengers.

Switching the air conditioning on or off

67959



4

In automatic mode, the system switches the air conditioning system on or off, depending on the climate conditions.

Press switch **4** to force activation (the warning light above comes on) or stop the air conditioning (the warning light above goes out).



Some buttons have an operating light indicating their operative state.

AIR VENTS, HEATING AND AIR CONDITIONING

Rear screen de-icing and demisting

Press button **10**, the indicator light above comes on. This function enables rapid demisting or de-icing of the rear screen and de-icing of the rear view mirrors (on equipped vehicles).

To exit this function, press button **10** again. Demisting automatically stops.

Air recirculation (isolation of the passenger compartment)

67969



This function is managed automatically but you can also activate it manually. In this case, the operation is confirmed by a warning light above button **7**.



Demisting/de-icing will still take priority over the air recirculation.

Note:

- during recirculation, air is taken from the passenger compartment and is recycled without any air being taken from outside the vehicle;
- air recirculation allows the passenger compartment to be isolated from the external atmosphere (useful when driving in polluted areas, etc.);
- to bring the passenger compartment to the desired temperature as quickly as possible.

Manual use

Press button **7**, the indicator light above comes on.

Note: in order to prevent the windows from misting up, the system may automatically deactivate the function. The integrated indicator light on button **7** goes out.

Prolonged use of this position may lead to odours, caused by non-renewal of air, and the formation of condensation on the windows.

We therefore advise you to return to automatic mode as soon as air recircu-

lation is no longer needed, by pressing button **7**.

To exit this function, press the button **7** again.

Stopping the system

Turn the control **1** to "OFF" to stop the system. To start it, turn the control **1** again to adjust the blower speed or press button **8**.



Fuel consumption increases when the air conditioning is being used (switch it off when it is not required).

Air conditioning: information and advice on use

Advice on use

In some situations, (air conditioning off, air recirculation activated, ventilation speed at zero or low, etc.) you may notice that condensation starts to form on the windows and windscreen.

If there is condensation, use the "**Clear View**" function to remove it, then use the air conditioning in automatic mode to stop it forming again.

AIR VENTS, HEATING AND AIR CONDITIONING



Do not add anything to the vehicle's ventilation circuit (for example, to remove bad odours).

There is a risk of damage or of fire.

Consumption

You will normally notice an increase in fuel consumption (especially when driving in town) when the air conditioning is operating.

For vehicles fitted with air conditioning with no automatic mode, switch off the system when it is not required.

Advice for reducing consumption and helping to preserve the environment

Drive with the air vents open and the windows closed.

If the vehicle has been parked in the sun, open the doors for a few moments to let the hot air escape before starting the engine.



Use the air conditioning system regularly, even in cold weather, running it at least once a month for approximately 5 minutes.

Maintenance

Refer to the maintenance document for your vehicle for the inspection frequency.

Operating faults

As a general rule, contact your Approved Dealer in the event of an operating fault.

– Reduction in de-icing, demisting or air conditioning performance.

This may be caused by the cabin filter cartridge becoming clogged.

– No cold air is being produced.

Check that the controls are set correctly and that the fuses are sound. Otherwise, switch off the system.

Special features of Hybrid versions

The vehicle's air conditioning system is also used to cool the traction battery.

A prolonged drop in air conditioning efficiency may lead to premature deterioration of the traction battery

Presence of water under the vehicle

After prolonged use of the air conditioning system, it is normal for water to be present under the vehicle. This is caused by condensation.



Do not open the refrigerant circuit. The fluid may damage eyes or skin.

Refrigerant fluid

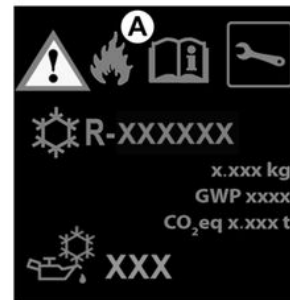

The refrigerant fluid circuit (of which some components are hermetically

AIR VENTS, HEATING AND AIR CONDITIONING

sealed) may contain fluorinated greenhouse gases.

Depending on the vehicle, you will find the following information on label **A** affixed inside the engine compartment.

The presence and location of the information on the label depends on the vehicle.

4



Type of refrigerant fluid



(XXX) Type of oil in the air conditioning circuit



Inflammable product



Consult the vehicle user manual



Maintenance

x.xxx kg	(1) Quantity of refrigerant fluid present in the vehicle.
GWP xxxx	(2) Global warming potential.
CO2 eq x.xxx t	(3) Quantity in weight and in CO2 equivalent.

Additional information

Depending on label and depending on the type of refrigerant:

Refrigerant fluid R-134a

Refrigerant fluid R-1234yf

- **(1)** 0,450 kg/0,465 kg/0,520 kg/0,650 kg
- **(2)** GWP 0.501
- **(3)** 0.0002 t/0.0003 t



Do not open the refrigerant circuit. The fluid may damage eyes or skin.



Before carrying out any action in the engine compartment, you must switch off the ignition

→ 162 or → 164.

MULTIMEDIA EQUIPMENT

Multimedia system



The presence and location of this equipment depends on the vehicle's multimedia equipment.

1. Multimedia screen.
2. Multimedia sockets USB-C in the centre console.
3. Accessories socket → 301.
4. Steering column control.
5. Voice command.
6. Multimedia socket.
7. Multimedia sockets USB-C for the rear passengers (depending on the vehicle).



Using the telephone

We remind you of the need to conform to the legislation in force concerning the use of such equipment.



Connect accessories with a maximum power of 12 watts only.
Fire hazard.

Multimedia port



Multimedia sockets USB-C 2 and 7 (depending on the vehicle) can be used to charge accessories with a maximum power of 12 Watts (5 Volts) per socket.

Note: the multimedia sockets USB-C 2 can also be used the transfer data.



If you connect a cable from an accessory to a USB port (e.g. a smartphone charging cable), be sure to disconnect it when no longer needed.

Risk of short circuit and damage to the USB port in the event of contact between the end of the cable and a metallic object (e.g. cigarette lighter, etc.).



Please refer to the multimedia instructions for further information.

MULTIMEDIA EQUIPMENT

Hands-free telephone integrated control



Use the microphone **8** and the steering column control **4**.



Using the telephone

We remind you of the need to conform to the legislation in force concerning the use of such equipment.

Induction charging area **9**



Depending on the vehicle, zone **9** is equipped with a magnetic device **C**. → 303



When driving, make sure that the container held by the cup holder is properly closed so that it does not tip over.
Risk of damage to surrounding electrical and/or electronic equipment in the event of liquid spillage.

MULTIMEDIA EQUIPMENT

Phone holder A



On vehicles that are equipped, lift the flap **10**, place your phone **13** horizontally onto the stand **11** then lower the flap **10** while keeping the phone in position on the stand **12**.



For safety reasons, carry out any adjustments while the vehicle is stationary.



Make sure that the telephone is securely held in place between the **11** and **12** stands before use.



Make sure that the telephone is securely held in place in the telephone holder to ensure that it is not thrown onto the occupants during sudden turning or braking.



Using the telephone

We remind you of the need to conform to the legislation in force concerning the use of such equipment.

Removable phone holder B

On vehicles that are equipped, to fit the removable telephone holder **B**, observe the following instructions:

MULTIMEDIA EQUIPMENT

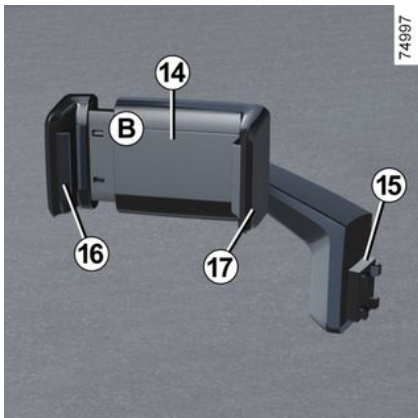

On vehicles that are equipped, to fit the removable telephone holder **B**, observe the following instructions:

- remove the cover **18** (movement **C**);
- attach the base **15** of the telephone holder to the component **19** (movement **D**);
- pull the clamp **16** to the left;

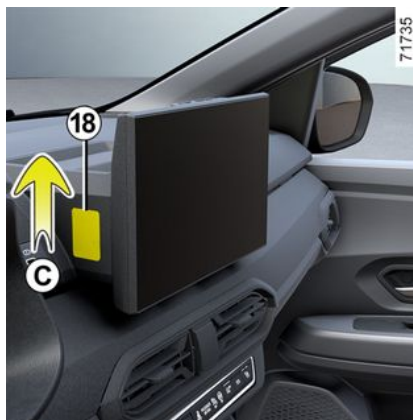

– place your telephone in the telephone holder **14** pressing the fixed clamp **17**, then release the clamp **16** so that the telephone is firmly held in place between clamps **16** and **17**.

To remove the removable telephone holder **B**, proceed in the reverse order.

Note: You can manually adjust the tilt of the telephone holder **14** to the desired position.



MULTIMEDIA EQUIPMENT



Make sure that the base of the telephone holder is correctly fitted and that the telephone is securely held in place in the telephone holder, so that it is not thrown onto the occupants during sudden turning or braking.



For safety reasons, carry out any adjustments while the vehicle is stationary.



Using the telephone
We remind you of the need to conform to the legislation in force concerning the use of such equipment.

PASSENGER COMPARTMENT EQUIPMENT

Electric windows

Electric windows

These systems operate with the ignition on or off, until one of the front doors is opened (limited to about 3 minutes).

4



Driver's responsibility

Never leave your vehicle with the card or key inside, with a child, adult

who is not self-sufficient or a pet in the vehicle, even for a short while.

They may pose a risk to themselves or to others by starting the engine or activating equipment (such as the gear lever or electric windows).

If any part of the body becomes trapped, reverse the direction of the window immediately by pressing the relevant switch.

Risk of serious injury.



The electric windows operate with the ignition switched on.

From the driver's seat

Press the window switch down or pull it up to lower or raise the window to the desired height.

- 1** for the driver's side;
- 2** for the front passenger's side;
- 3** and **5** for the rear passengers.

Passenger safety

The driver can deactivate operation of the rear passenger electric windows by pressing switch 4. A confirmation message is displayed on the instrument panel or, depending on the vehicle, the indicator light built into the switch lights up.



From the front passenger seat

Press the switch **6**.



Avoid resting any objects against a half-open window: there is a risk that the electric window could be damaged.

One-touch mode

This mode works in addition to the operation of the electric windows described previously.

Briefly press or pull a window switch as far as it will go: the window will be

PASSENGER COMPARTMENT EQUIPMENT

fully raised or lowered. Pressing the switch again stops the window moving.

Impossible to operate the electric window

The electric window is equipped with a heat protection mode: if you press the window switch repeatedly (many times within a few minutes), it goes into protection mode (locking the window in the closed position).

To end the heat protection mode, with the ignition on do not perform any action on the switch for approximately 20 minutes. The protection will be automatically deactivated at the end of this time period.

Until then, the use of the electric window is limited. After approximately five minutes you will be able to press the switch up to four times within approximately five minutes.

Note: if the ignition is switched off before the end of the 20-minute period, the procedure will have to be started from the beginning.

From the rear seats



Press the switch 7.



When closing the windows, ensure that no part of the body (arm, hand, etc.) is protruding from the vehicle.

Risk of serious injury.



Safety of rear occupants

The driver can prevent the operation of the rear electric windows by pressing switch 4. A confirmation message is displayed on the instrument panel.

Driver's responsibility

Never leave your vehicle with the key inside, and with a child, a dependent adult or a pet, even for a short while.

They may pose a risk to themselves or to others by starting the engine or activating equipment (such as the gear lever or electric windows).

If any part of the body becomes trapped, reverse the direction of the window immediately by pressing the relevant switch.

Risk of serious injury.

Remote control window opening/closing

When unlocking the doors from the outside, if you **press and hold the card unlocking button**, all the win-

PASSENGER COMPARTMENT EQUIPMENT

dows equipped with a one-touch electric window will open automatically.

When locking the doors from the outside, if you **press and hold the card locking button**, all the windows equipped with a one-touch electric window will close automatically.

It is recommended that the user only operates the system when the vehicle can be seen clearly and no one is inside.



When closing the windows, ensure that no part of the body (arm, hand, etc.) is protruding from the vehicle.

Risk of serious injury.

Operating faults

In case of a fault when closing a window, the system reverts to normal mode: pull the switch concerned up as often as necessary to fully close the window (the window will close gradually), hold the switch (still on the closure side) for one second then lower and raise the window fully to reinitialise the system.

If necessary, contact an approved dealer.

Manually operated rear windows



Turn the handle **8** to lower or raise the window to the desired height.

Interior lighting

Courtesy light

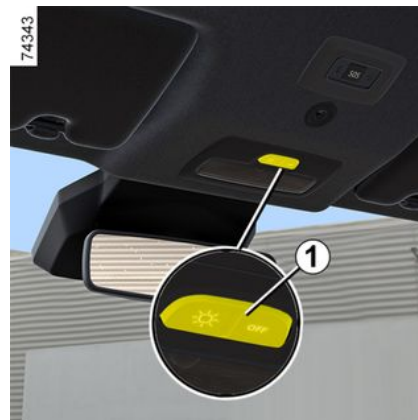

Press switch **1**, or, depending on the vehicle, switch **2** or **3** to enable:

- continuous lighting;
- or temporary lighting, controlled by opening one of the front doors, or by opening one of the four doors, depending on the vehicle. The light only goes out when the doors are correctly closed;
- or else the light definitively turned off.

PASSENGER COMPARTMENT EQUIPMENT

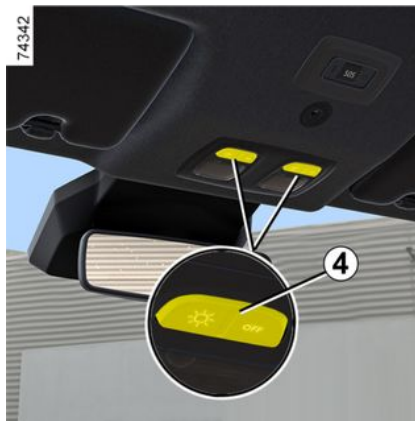

Map reading lights

(depending on the vehicle)

Press switch **4** to enable:

- continuous lighting;
- or temporary lighting, controlled by opening one of the front doors, or by opening one of the four doors, depending on the vehicle. The light only goes out when the doors are correctly closed;
- or else the light definitively turned off.

Glove box light

(depending on the vehicle)



The light **5** comes on when the cover is opened.

Luggage compartment light

(depending on the vehicle)

PASSENGER COMPARTMENT EQUIPMENT



The light **6**, comes on when the luggage compartment is opened.



Automatic operation of interior lighting (depending on the vehicle)

- if the doors are unlocked using the remote control, the interior lighting is switched on for approximately 30 seconds.
- If a door is open (or not properly closed), the lighting is switched on for approximately 1 to 3 minutes.
- if all the doors are closed, the interior lighting starts to dim when the ignition is switched on.

Sun visor, mirror, grab handle

Sun visor **1** and **2**



Lower the sun visor **1** or **2** over the windscreen or unclip it and flip it to cover the side window.

PASSENGER COMPARTMENT EQUIPMENT

Courtesy mirrors 3



Depending on the vehicle, the sun visors are fitted with a courtesy mirror. Lift the cover 4.

Grab handles for the front 5 and rear 6 or, depending on the vehicle, 7

These can be used for support by passengers while the vehicle is moving. Do not use them for getting into or out of the vehicle.

Clothes hooks 8



Accessories socket, ashtray, cigarette lighter

Ashtray 1



This may be stored in housing 2 or 4. Lift the cover to open. To empty, pull the ashtray towards you and it will be released from its housing.

 If your vehicle is not fitted with a cigarette lighter and an ashtray, these can be obtained from an approved dealer.

PASSENGER COMPARTMENT EQUIPMENT

Cigarette lighters **3** and **5** or, depending on the vehicle, **6**



With the ignition on, push in cigarette lighter **3**. It will spring back with a click when it is ready. Pull it. After use, replace it without pushing it all the way in.

Accessories sockets **3 and **5** or, depending on the vehicle, **6****

The sockets are provided to connect accessories approved by our Technical Department.



Connect accessories with a maximum power of 120 Watts (12 V) only. When several accessory sockets are used at the same time, the total power of the connected accessories must not exceed 180 watts.

Fire hazard.

PASSENGER COMPARTMENT STORAGE, FITTINGS

Front door storage compartments 1



Nothing should be placed on the floor (area in front of the driver) as these objects may slide under the pedals during sudden braking manoeuvres, thus obstructing their use.

Centre console storage compartment



When driving, make sure that the container held by the cup holder is properly closed so that it does not tip over. **Risk of damage to surrounding electrical and/or electronic equipment in the event of liquid spillage.**

Centre console storage compartment/Induction charging zone 2



Depending on the vehicle, zone 2 is equipped with a magnetic device **C** that is designed to hold your smartphone in place, provided that it is equipped with magnetic technology or that it is equipped with a compatible (magnetic) case. This system enables stable attachment while optimising the charging of your device.

For more information on the charging status, please refer to the multimedia instructions.

PASSENGER COMPARTMENT STORAGE, FITTINGS

4  It is essential not to leave any objects (start-up card, USB drive, SD card, credit card, jewellery, keys, coins, etc.) **2** in the induction charging zone when charging your phone. Remove any magnetic cards or credit cards from the phone case before positioning your telephone in the induction charging area **2**.

 Objects left in the induction charging area **2** may over-heat. You are advised to place them in the areas provided for this purpose (storage compartment, sun visor compartment etc.).

Placement for cup or ashtray **3**



Ensure that no hard, heavy or pointed objects are placed in the "open" storage compartments in such a way that they may fall onto passengers during sharp turning, sudden braking or in the event of an impact.

Passenger side storage compartment



Pull handle **4** to open it.

This glove box can be used to store A4 format documents.

Inside the cover, a compartment is provided for pens, maps, etc.



Nothing should be placed on the floor (area in front of the driver) as these objects may slide under the pedals during sudden braking manoeuvres, thus obstructing their use.

Centre console storage compartment **5**

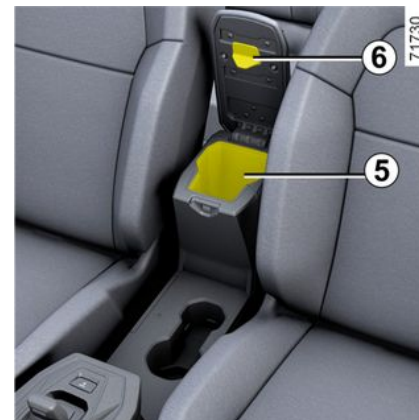

PASSENGER COMPARTMENT STORAGE, FITTINGS

Lift the central armrest cover **6**.

Rear storage compartment **7**



Rear door storage compartment **8**



Ensure that no hard, heavy or pointed objects are placed in the "open" storage compartments in such a way that they may fall onto passengers during sharp turning, sudden braking or in the event of an impact.

Front seat storage compartments **9**

(depending on the vehicle)

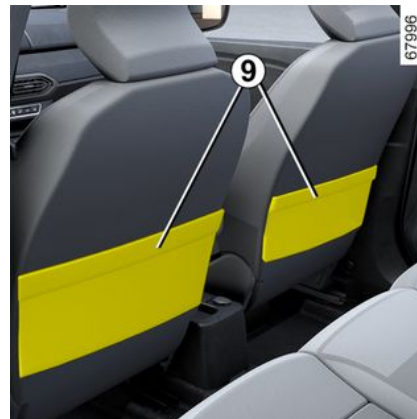

Bag hooks **10**



Maximum weight per hook: 5 kg.

PASSENGER COMPARTMENT STORAGE, FITTINGS

Cup holder **11** and storage compartment **12**



i When driving, make sure that the container held by the cup holder is properly closed so that it does not tip over.
Risk of damage to surrounding electrical and/or electronic equipment in the event of liquid spillage.

Rear trays **13**

(depending on the vehicle)

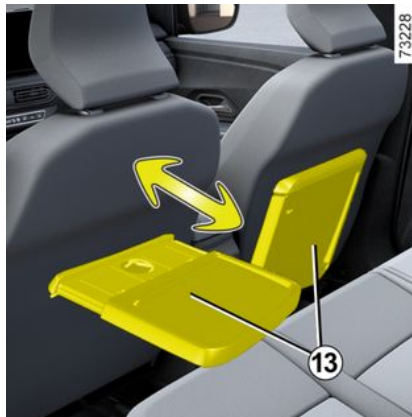

Raise the tray to the horizontal position.

It is recommended that you use the trays **13** only while the vehicle is stationary.

Multi-accessory holder YouClip **14**, **15**, **16** and **17**

Depending on the vehicle, they are designed to secure the cube **18**, the lamp **21**, the bag hook **23** (located in the luggage compartment) or the accessories approved by the brand's Technical Department.

Contact an approved Dealer for all advice.



Ensure that accessories YouClip are correctly fitted so that they may not be projected onto passengers during sudden turning, braking or in the event of an accident.



PASSENGER COMPARTMENT STORAGE, FITTINGS



Cube 18

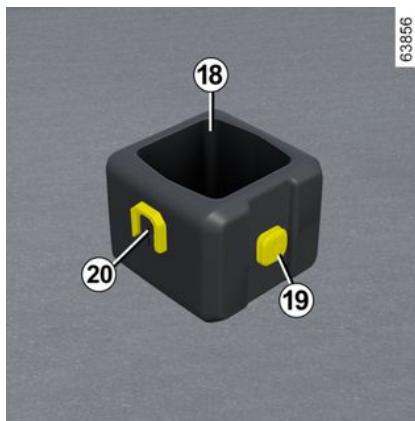

To install the cube on equipped vehicles, slide the base **20** of the cube from top to bottom on the multi-accessory holder **14** or **15**.

You can use the cube as a cup holder.

To remove the cube, slide the base **20** of the cube from bottom to top on the multi-accessory holder.

Maximum weight per cube: 0.5 kg.

Lamp 21

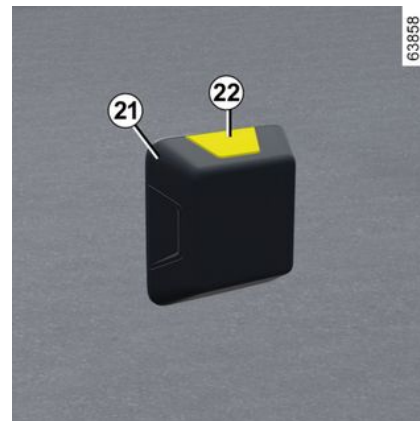

You can attach the lamp to the base **19** of the cube or to one of the multi-accessory holders **14**, **15**, **16** or **17**. Press the button **22** to switch on the lamp.

PASSENGER COMPARTMENT STORAGE, FITTINGS

Bag hook 23

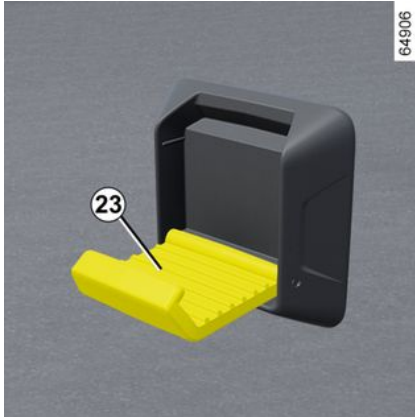

You can attach the bag hook to the base **19** of the cube or to one of the multi-accessory holders **14**, **15**, **16** or **17**.

Maximum weight per hook on the base of the cube: 1 kg.

Maximum weight per hook on the base **14**: 2 kg.

Maximum weight per hook on the base **16**: 5 kg.

TRANSPORTING OBJECTS

Luggage compartment storage

Luggage cover

To roll up the luggage cover **1**



Pull luggage cover **1** gently towards you, holding it by the ends (movement **A**), to release the pins from their mounting points located on each side of the luggage compartment.

Use the ends to guide the luggage cover as it rolls up.

Removing/refitting the luggage cover



Push the luggage cover to the right (movement **B**) and lift the left-hand side of the inertia reel.

To refit the luggage cover, insert the right-hand side, then push it to the right and lower the left-hand side of the reel into its housing.



No person or animal should be on the third row rear seats if the luggage compartment cover is not removed.

Luggage compartment cover storage



You can store the luggage cover **1** directly on the floor.

To do this, remove the cover **2** and insert the right-hand side of the folded luggage cover **1** into the housing **3**.



Do not place any objects, especially heavy or solid objects on the luggage cover. These may pose a risk to the vehicle occupants if the driver has to brake suddenly or if the vehicle is involved in an accident.

TRANSPORTING OBJECTS

Luggage compartment storage space and fittings

Anchorage points

The anchorage points **1** located in the luggage compartment allow loads to be secured.

i Always position objects being transported so that the heaviest items are resting against the back of the rear bench seat.

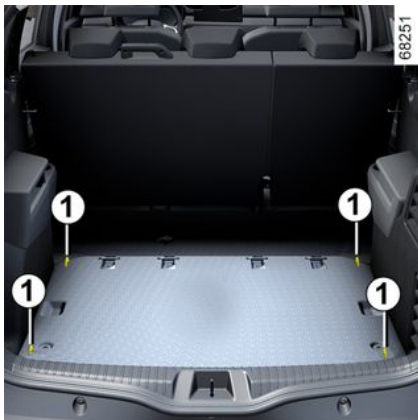

Always position the heaviest items directly on the floor. If the vehicle is equipped with anchorage points on the luggage compartment floor, use them. The luggage should be loaded in such a way that no items will be thrown forward and strike the occupants if the driver has to brake suddenly. Fasten the rear seat belts, even if the seats are not occupied.

Transporting objects in the luggage compartment

Always position the objects transported so that the largest surface is against:



the rear bench seatbacks, for normal loads (example **A**);



73219

73220

TRANSPORTING OBJECTS

the front seats when the rear seats are folded down → 59 (example **B**).

Ensure that the objects being transported are evenly distributed throughout the loading area.

If you have to place objects on the folded seat back, it is vital that you remove the headrests before folding the seat back so that it can be folded as flat as possible against the seat.



Always position the heaviest items directly on the floor. If the vehicle is equipped, use the lashing points **1** located on the luggage compartment floor. The luggage should be loaded in such a way that no items will be thrown forward and strike the occupants if the driver has to brake suddenly. Fasten the rear seat belts, even if the seats are not occupied.



Luggage net



If fitted, this can be used when transporting animals or luggage to isolate them from the passenger section.

It is fitted behind the second row bench seat or behind the driver and passenger seats.



The luggage net must not be used to restrain or hold objects.
Risk of injury.

Fitting the luggage net behind the second row rear seats



Inside the vehicle, on each side:
– remove the third row rear seats;

TRANSPORTING OBJECTS

- insert the upper rod of the net **4** into the anchoring points;
- lift the cover **2** to gain access to the anchoring points used to attach the top of the net;
- insert the upper rod of the net **4** into the anchoring points;
- attach the two hooks **6** of the net straps **5** to the anchoring points **3**;
- adjust the net strap **5** so that it is taut.



Do not install the luggage net in this position when a passenger is occupying a rear seat.

The label **A** located on the side of the luggage net reminds you of these instructions.

Fitting the luggage net behind the front seats

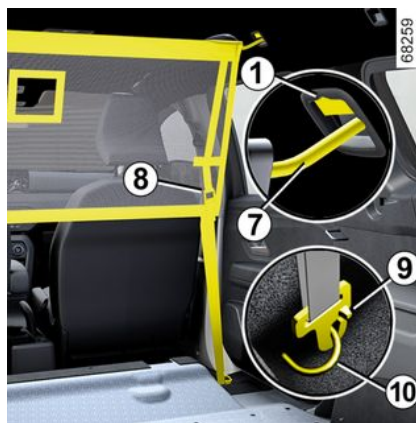

Inside the vehicle, on each side:

- raise the seat and second-row rear bench seat until it is upright;

- lift the cover **1** to gain access to the anchoring points used to attach the top of the net;
- insert the upper rod of the net **7** into the anchoring points;
- attach the two hooks **9** of the net straps **8** to the anchoring points **10**;
- adjust the net strap **8** so that it is taut.



The luggage net is designed to retain a maximum weight of 10 kg.
Risk of injury.

TRANSPORTING OBJECTS

Towing



Choice and fitting of towing equipment

Maximum weight of towing equipment

Towbar (cross member and hitch) not originally fitted to the vehicle: the entire towbar and mountings must not exceed **23 kg**.

Any towing device must not obstruct any lighting component or the number plate when not in use. In all cases, you must comply with the regulations of the particular country you are in.

For fitting and conditions of use, refer to the equipment's fitting instructions.

Please keep these instructions with the rest of the vehicle documentation.

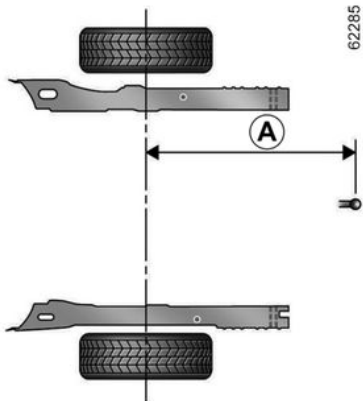

Estate version:

A = 944 mm maximum

62286

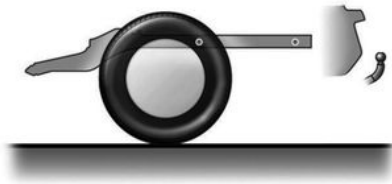

Carrying equipment

User precautions

Using the tailgate

Before operating the tailgate, check the objects and/or accessories (bicycle rack, roof box, etc.) fitted on the roof bars: these must be correctly positioned and secured, and must not prevent the luggage compartment door from operating correctly.



Ensure that the objects being transported are evenly distributed throughout the equipment loading area.



It is prohibited to attach any carrying device (bicycle rack, cargo box, etc.) resting on the tailgate. To install a carrying device on your vehicle, contact an approved Dealer.

TRANSPORTING OBJECTS

Roof carrying equipment



It is forbidden to attach any carrying device the roof of vehicles not originally fitted with longitudinal or modular roof bars.



For information on the range of equipment adapted to your vehicle, we advise you to consult an approved Dealer. Refer to the manufacturer's instructions for information on how to fit and operate the equipment. Please keep these instructions with the rest of the vehicle documentation.

Vehicles fitted with modular roof bars

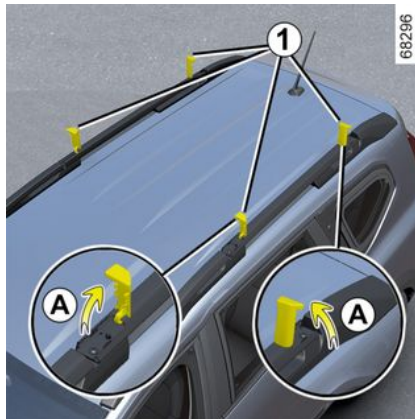

If the vehicle is equipped, this device enables you to position the roof bars in either the transverse position (carrying position) or the longitudinal position (standard position).

Maximum permissible load on roof bars: 80 kg (including the carrying equipment).

To place the bars in the transverse position:

– unclip the rotary covers **1** and put them in the vertical position (movement **A**);

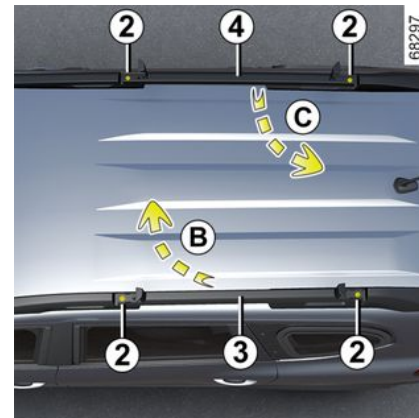

- loosen the bolts **2** using the torque wrench **7** located in the glovebox;
- raise bars **3** and **4** and fit them in transverse position **5**. To do this, place the bar **3** (movement **B**) in the front position, then place the bar **4** (movement **C**) in the rear position.

TRANSPORTING OBJECTS

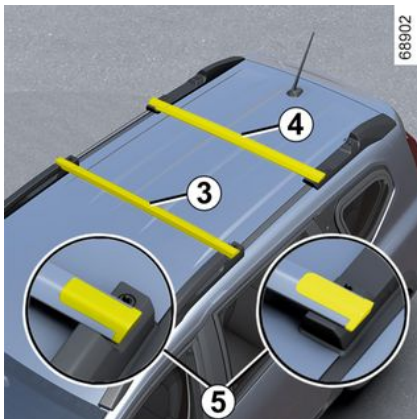

68902

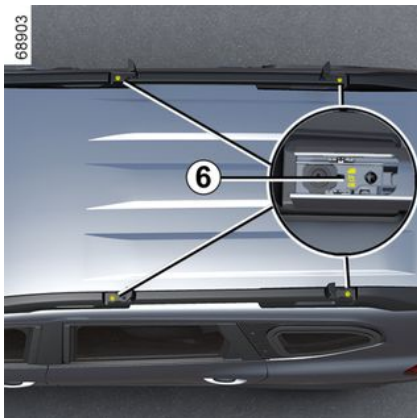

68903

Note: make sure that bars **3** and **4** are positioned correctly and, depending on the vehicle, that they comply

with the direction shown on each mark **6** located on the mountings at each end of the bars.

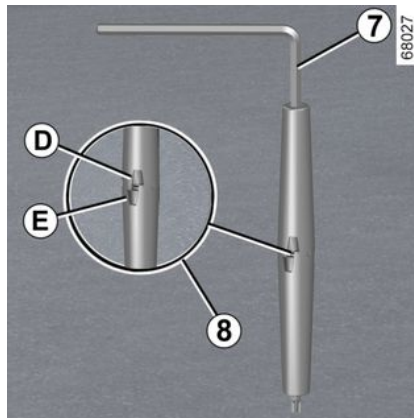

68027

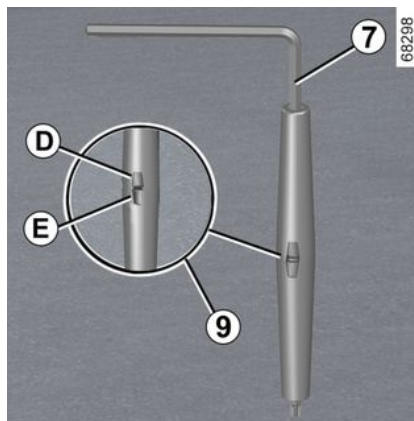

68298

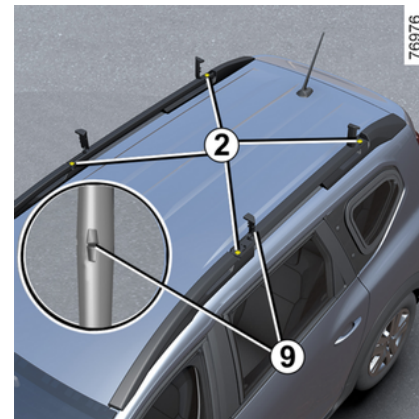

76976

4

- use the tool **7** to tighten the bolts **2**: markers **D** and **E** located on the tool are offset (mark **8**);
- tighten the bolts **2** as far as possible using the tool **7** until markers **D** and **E** located on the tool **7** are parallel (mark **9**);
- re-clip the rotary covers **1**.

Note: bars **3** and **4** are not interchangeable.



It is strictly forbidden to place the roof bars in the transverse position (carrying position) when entering a roller-type car wash.

TRANSPORTING OBJECTS



Roof bars in the transverse position

The maximum speed must be limited to 80

mph (130 km/h).

During the journey, check the installation and tighten the bolts every 300 miles (500 km) or so.



When not using the bars in transverse position, refit the bars in longitudinal position in order to optimise fuel consumption and avoid air noise.

To place the bars in the longitudinal position:

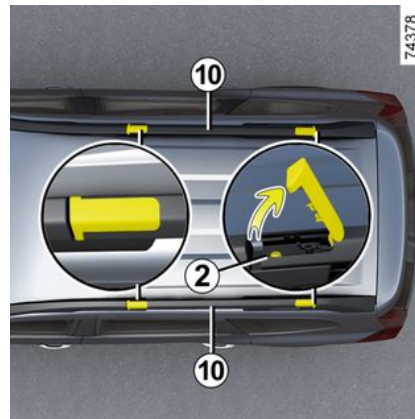
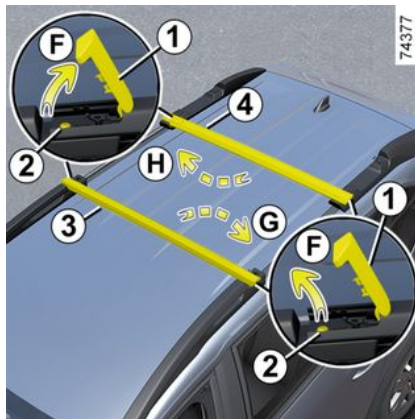

- unclip the rotary covers **1** and put them in the vertical position (movement **F**);
- loosen the bolts **2** using the torque wrench **7** located in the glovebox;
- raise bars **3** and **4** and fit them in the longitudinal position **10**. To do this, put the bar **3** (movement **G**) and bar **4** (movement **H**) in the longitudinal position.

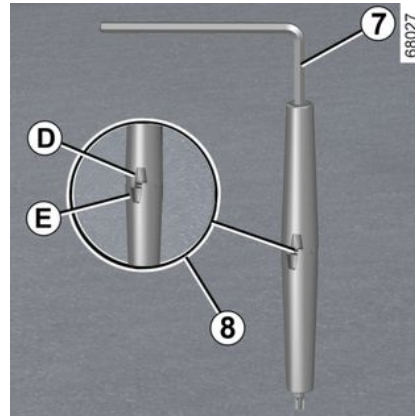

TRANSPORTING OBJECTS

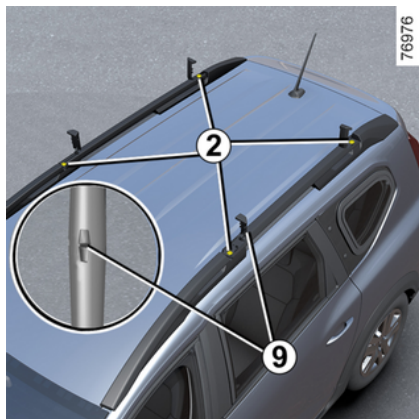
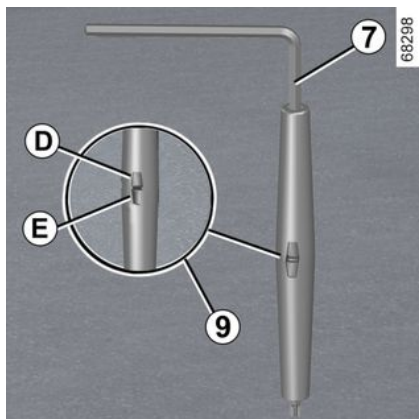

– tighten the bolts **2** as far as possible using a torque wrench **7** until markers

D and **E** located on the tool **7** are parallel (mark **9**);

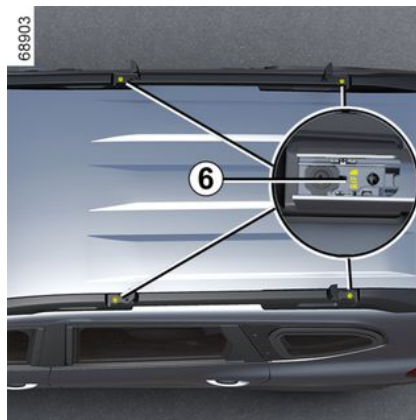

Note: make sure that bars **3** and **4** are positioned correctly and, depending on the vehicle, that they comply with the direction shown on each mark **6** located on the mountings at each end of the bars.

– re-clip the rotary covers **1**.

Note: bars **3** and **4** are not interchangeable.



Make sure that the two modular roof bars are correctly positioned and locked.



The modular roof bars are originally assembled and approved by our Technical Department. They are provided together with the bolts **2** and the tool **7**. These must only be used for attaching the roof bars to the vehicle. In the event of loss, contact an approved Dealer to obtain them.



Check that the objects and/or accessories (bike rack, roof box etc.) fitted to the modular roof bars are correctly positioned, evenly distributed and secured.

TRANSPORTING OBJECTS

Vehicles fitted with longitudinal roof bars



4

If fitted on the vehicle, you can transport luggage or additional equipment (bicycle rack, ski rack, etc):

- on a roof rack;
- on transverse roof bars fitted onto the longitudinal roof bars **11**;
- directly onto the longitudinal roof bars.

Maximum permissible load on roof bars: 80 kg (including the carrying equipment).

ACCESSING THE ENGINE, LEVELS

Bonnet



To open the bonnet, pull the handle **1** located on the left-hand side of the dashboard with a door open.

Unlocking the bonnet catch

To unlock, gently lift the bonnet and push the tab **4** in the direction indicated by the arrow **A** to release the catch **2**.

 Before carrying out any operation in the engine compartment, you must switch off the ignition
→ 162 → 164.

Opening the bonnet





Raise the bonnet and disengage the stay **6** from its mounting **3**; for your own safety, place the stay in its retainer **5**.

Closing the bonnet

Check that nothing has been left in the engine compartment.

To close the bonnet, refit the stay **6** into its mounting **3**, hold the bonnet in the middle then lower the bonnet to 30 cm above the closed position before letting go. It will latch automatically under its own weight.

 Please note when working close to the engine that it may be hot. The engine cooling fan may also start at any moment. The  label in the engine compartment reminds you of this.
Risk of injury.

 When working in the engine compartment, ensure that the windscreen wiper stalk is in the park position.
Risk of injury.

ACCESSING THE ENGINE, LEVELS



Avoid placing any pressure on the engine bonnet: risk of the bonnet closing by accident.



Ensure that the bonnet is properly locked.
Ensure that nothing is preventing locking (grit, cloths, etc.).



After any procedure in the engine compartment, make sure that you do not forget anything (cloth, tools, etc.).
Otherwise, this may lead to engine damage or cause a fire.



In the event of even a slight impact involving the radiator grille or bonnet, have the bonnet lock checked by an approved dealer as soon as possible.

Engine oil

General information

A combustion engine uses oil for lubrication and cooling of moving parts and it is normal to top up the level between scheduled oil changes.

However, contact your approved Dealer if more than 0.11 gal (0.5 litre) is being consumed every 600 miles (1,000 km) after the running in period.

Oil change frequency: check the oil level from time to time and certainly before any long journey to avoid the risk of damaging your engine.

Reading the oil level

The oil level should be read with the vehicle on level ground, after the engine has been switched off for some time.

The dipstick must be used to read the exact oil level and make sure that the maximum level has not been exceeded (risk of engine damage).

Depending on the vehicle, the instrument panel display only alerts the driver when the oil level is at its minimum.

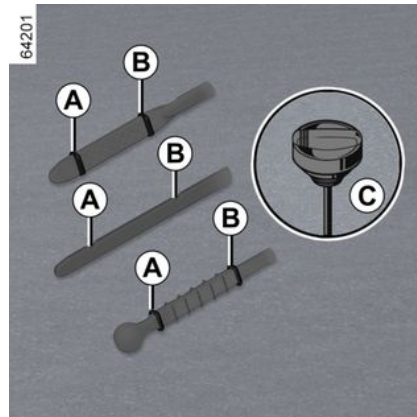

- Remove the dipstick and wipe with a clean, lint-free cloth;
- push the dipstick in as far as it will go (for vehicles equipped with a "cap-dipstick" **C**, screw the cap in as far as it will go);
- remove the dipstick again;
- read the level: it should never fall below the "MINI" level **A** nor exceed the "MAXI" level **B**.

Once the operation has been completed, ensure that the dipstick is pushed in as far as it will go or that the "cap-type dipstick" is completely screwed in.

ACCESSING THE ENGINE, LEVELS



Use a funnel or protect the filling neck area to avoid engine oil escaping onto a hot part of the engine compartment or a sensitive part (e.g. electrical components).

Fire hazard.



Exceeding the maximum engine oil level

Under no circumstances should the maximum filling level **B** be exceeded: this could damage the engine and the emission control system. If the level exceeds the MAXI level, **do not start your vehicle**, contact an approved Dealer.

Topping up, filling, oil change

Topping up/Filling

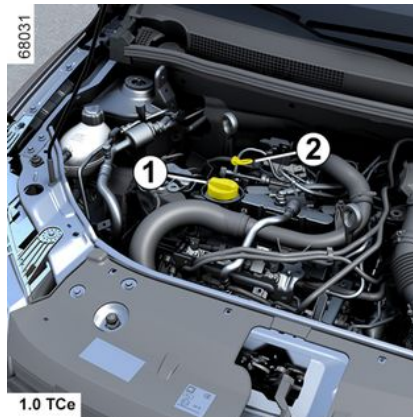

The vehicle must be parked on level ground and the engine should be stopped and cold (e.g. before the engine is started up for the first time that day).



Before carrying out any action in the engine compartment, you must switch off the ignition

→ 162 or → 164.



Do not exceed the "**MAXI**" level and do not forget to refit the cap **1** and the dipstick **2**.

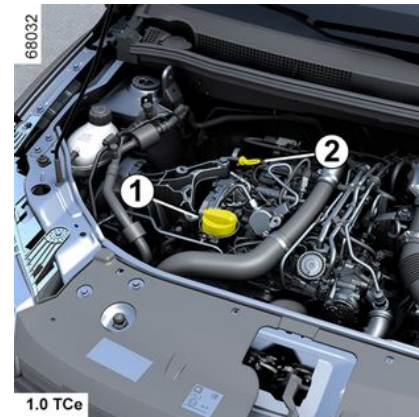

- Loosen the cap **1**;
- top up the level (as a guide, the capacity between the "MINI" and the "MAXI" mark on the dipstick **2** is between 0.33 and 0.44 gallons (1.5 and 2 litres) depending on the engine);
- wait for approximately 20 minutes to allow the oil to flow;
- check the level using the dipstick **2** (as described previously).

ACCESSING THE ENGINE, LEVELS

Once the operation has been completed, ensure that the dipstick is pushed in as far as it will go or that the "cap-type dipstick" is completely screwed in.

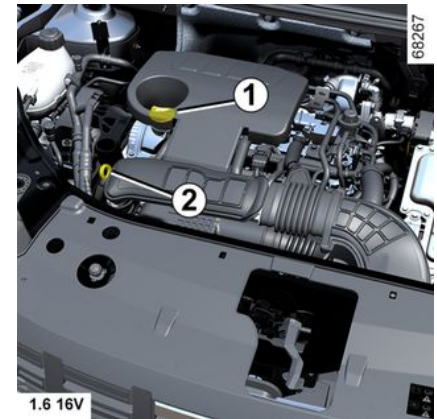
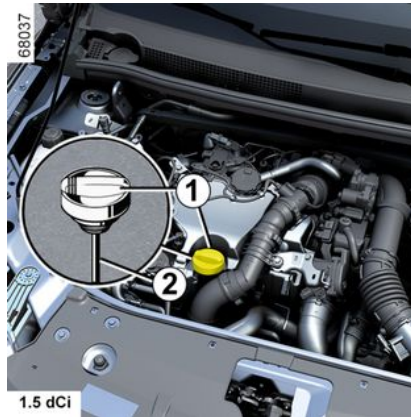
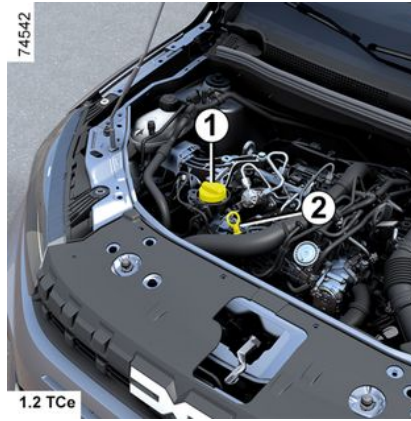
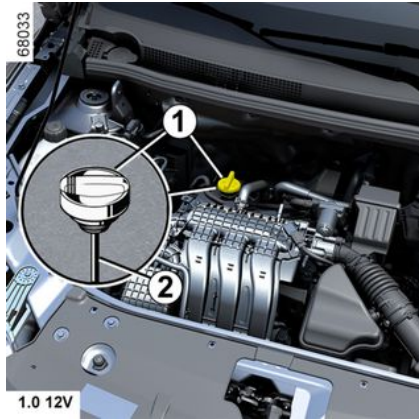

Exceeding the maximum engine oil level

Under no circumstances should the maximum

filling level be exceeded: this could damage the engine and the emission control system.

If the level exceeds the MAXI level, **do not start your vehicle**, contact an authorised dealer.

ACCESSING THE ENGINE, LEVELS

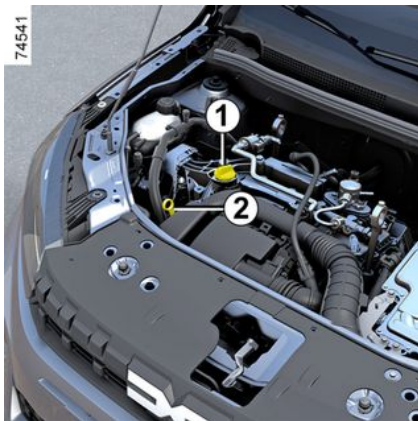

Oil change

Service interval: refer to the maintenance document for your vehicle.

Oil change capacity

Please refer to the maintenance document for your vehicle, or contact an authorised dealer.

Always check the engine oil level using the dipstick, as explained previously (it should never fall below the minimum level, or be over the maximum level on the dipstick).

Engine oil grade

Refer to the maintenance document for your vehicle.



Adding engine oil

Use a funnel or protect the filling neck area to avoid engine oil escaping onto a hot part of the engine compartment or a sensitive part (e.g. electrical components).

Fire hazard.



Never run the engine in an enclosed space as exhaust gases are poisonous.



When working in the engine compartment, ensure that the windscreen wiper stalk is in the park

position.

Risk of injury.



Filling and/or checking the oil level:

when topping up or checking the oil level, ensure that no oil leaks onto the engine components.

Do not forget to properly close the cap and refit the dipstick to prevent any oil spatter on hot engine components.

Fire hazard.



Please note when working close to the engine that it may be hot. The engine cooling fan may also start at any moment. The



label in the engine compartment reminds you of this.

Risk of injury.



If there is an abnormal or repeated drop in the fluid level, consult an approved Dealer.

ACCESSING THE ENGINE, LEVELS



Engine oil change: if you are changing the oil when the engine is hot, be careful not to scald yourself as the oil drains.

Coolant level

Combustion engine coolant



With the engine off and the vehicle on flat ground, the level **when cold** must be between the "MINI" and "MAXI" marks on the coolant reservoir **1**.

Top this level up **when cold** before it reaches the "MINI" mark.

Frequency of checking coolant level
Check the coolant level regularly (very severe damage is likely to be caused to the engine if it runs out of coolant).

If the level needs to be topped up, only use products approved by our Technical Department which ensure:

- antifreeze protection;
- anti-corrosion protection of the cooling system.



No operations should be carried out on the cooling circuit when the combustion engine is hot.

Risk of burns.

Replacement intervals

Refer to the maintenance document for your vehicle.



If there is an abnormal or repeated drop in the fluid level, consult an approved Dealer.



When working close to the combustion engine, be aware that it may be hot. The engine cooling fan may also start at any moment.



The  label in the engine compartment reminds you of this.
Risk of injury.

Electric traction system coolant

(hybrid version)

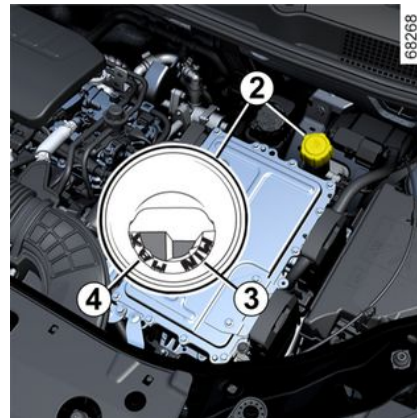

This system is different to that of the combustion engine. It is used for cooling the electric motor.

ACCESSING THE ENGINE, LEVELS

Reading the level

With the ignition off and the vehicle parked on level ground, unscrew the coolant reservoir cap **2**.

The level **when cold** must be between the "MIN" **3** and "MAX" marks **4** shown on the inside of the funnel.

Frequency of checking coolant level

Check the coolant level regularly (very severe damage is likely to be caused to the electrical circuit if it runs out of coolant).

If a top-up is required, you must contact an approved dealer to perform the top-up.

Replacement intervals

Refer to the maintenance document for your vehicle.

Levels, filters

Brake fluid level



 This should be checked frequently, and immediately if you notice even the slightest loss in braking efficiency.

The level should be read with the engine switched off and on level ground.



Before carrying out any action in the engine compartment, you must switch off the ignition

➔ 162 or ➔ 164.

Level

It is normal for the level to drop as the brake shoes become worn, but it must never drop below the "MINI" warning line shown on the brake fluid reservoir **1**.

If you wish to check the disc and drum wear yourself, you should obtain the document explaining the checking procedure from the manufacturer's network or website.



When working in the engine compartment, ensure that the windscreen wiper stalk is in the park position.

Risk of injury.

Topping up

After any operation on the hydraulic circuit, a specialist must replace the fluid.

Only use fluids approved by the Technical Department and which have been taken from a sealed container.

Replacement intervals

Please refer to the maintenance document for your vehicle.

ACCESSING THE ENGINE, LEVELS



If there is an abnormal or repeated drop in the fluid level, consult an approved Dealer.

Screen washer

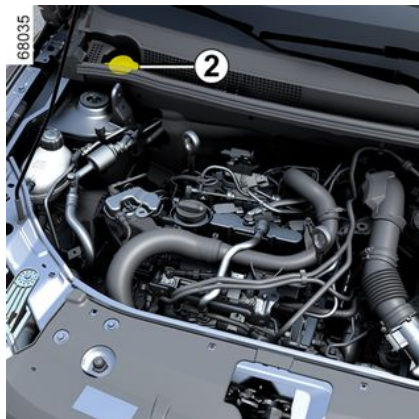

Topping up



With the engine off, open the cap 2. Fill until you can see the fluid, then replace the cap.

This reservoir supplies the front and rear headlight screen washers (if the vehicle is equipped with them).

Note: check the reservoir level regularly and top up the fluid before going on a trip.

Fluid: you should only use windscreen washer fluid containing anti-freeze.

We advise you to consult an approved dealer or a qualified professional.

Note: do not use hard water (risk of damage to the priming pump or of limescale building up on the pump and the jets).

Jets: use a tool such as a needle to adjust the height of the windscreen washer jets.

Filters

The replacement of filter elements (air filter, cabin filter, diesel filter etc.) is scheduled in the maintenance operations for your vehicle.

Replacement intervals for filter components: refer to the maintenance document for your vehicle.

Cabin filter

If your vehicle is not originally fitted with a cabin filter, it is possible to have one retrofitted.

Contact an approved Dealer.



Before carrying out any operation in the engine compartment, you must switch off the ignition
➔ 162, ➔ 164.



When working in the engine compartment, ensure that the windscreen wiper stalk is in the park position.
Risk of injury.



Please note when working close to the engine that it may be hot. The engine cooling fan may also start at any moment. The



label in the engine compartment reminds you of this.
Risk of injury.

BATTERY

"12 V" battery



The battery **1** does not require maintenance. **You should not open it or add any fluid.**



Handle the battery **1** with care as it contains sulphuric acid which must not come into contact with the eyes or the skin. If it does, wash the affected area with plenty of cold water and consult a doctor, if necessary.

Keep any flames, red hot objects or sparks away from the battery components (risk of explosion).

Depending on the vehicle, a system continuously checks the battery charge status. If this decreases, the "12V battery backup mode" message appears on the instrument panel followed by "Battery Low Start Engine". In this case, start the engine, drive the vehicle or wait until the message disappears from the instrument panel.

Note: after 5 to 30 minutes of vehicle use with the engine off, the "12V battery backup mode" message may be displayed to warn the user that the power consuming functions (interior lighting, radio, navigation, ventilation, accessories power supply, etc.) may be automatically cut off.

Your battery charging status may diminish, especially if you are using your vehicle:

- for short trips;
- in an urban setting;
- when the temperature is low;
- after extended use of energy-consuming devices (radio, etc.) with the ignition switched off.



Before carrying out any operation in the engine compartment, you must switch off the ignition

→ 162, → 164.

5



BATTERY



Please note when working close to the engine that it may be hot. The engine cooling fan may also start at any moment. The



label in the engine compartment reminds you of this.

Risk of injury.

- **8** refer to the manual;
- **9** corrosive materials.



For your own safety and for the proper operation of the vehicle's electrical equipment (lights, wind-screen wipers, ABS, etc.), any intervention on the battery (removal, disconnection, etc.) must categorically be performed by a specialist professional.

Risk of serious burns from electric shocks.

You must respect the replacement intervals (without exceeding them) as stated in the maintenance document.

The battery is a specific type.

Please ensure it is replaced with the same type.

Call an approved Dealer.

"12 V" secondary battery

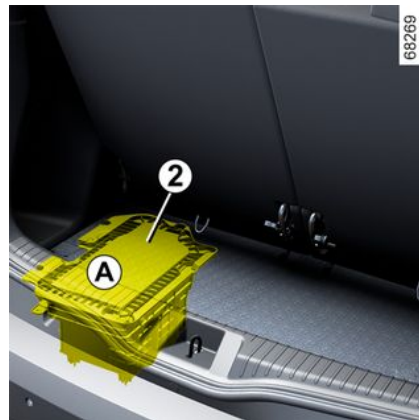

The "12 V" battery **2** is located at the rear of the vehicle Hybrid: it supplies the power required to unlock/lock the vehicle and to operate the equipment.

You should not open it or add any fluid.

The "12 V" battery charge level **2** may decrease, especially if you use your vehicle:

- when the outside temperature drops;
- after extended use of power-consuming functions while the ignition is switched off;
- after a prolonged period of parking.

5



Label A

- **4** naked flames and smoking are prohibited;
- **5** eye protection compulsory;
- **6** keep away from children;
- **7** explosive material;

BATTERY



For your own safety and to ensure the proper operation of the vehicle's electrical equipment

(lights, windscreen wipers, ABS, etc.), any operation on the "12 V" battery (removal, disconnection, etc.) **must** be performed by a qualified specialist.

Risk of serious burns or electric shocks.

You **must** respect the replacement intervals (without exceeding them) as stated in the maintenance document.

The battery is a specific type.

Please ensure it is replaced with the same type.

Call an approved Dealer.



It is prohibited to disconnect the "12 V" battery.

Risk of serious burns or electric shocks.

Secondary 48 V battery



Depending on the vehicle, a secondary battery **3** is located under the front passenger seat or under the driver's seat in a specific compartment: it supplies the energy required to operate some equipment.

The secondary battery **3** does not require any maintenance. **You should not open it or add any fluid.**

Label **B**



The label **B** is located on the battery **3**:

- **10** hazardous electrical voltage;
- **11** risk of explosion;
- **12** corrosive materials;
- **13** naked flames and smoking are prohibited;
- **14** do not dispose of as waste;
- **15** recyclable materials;
- **16** eye protection compulsory;
- **17** refer to the manual;
- **18** keep away from children.

Note: to ensure its performance and proper operation, the secondary battery **3** is fully recharged during driving, at regular intervals (approximately once every two months).

BATTERY

On such occasions, you may experience a temporary decrease in power and/or engine braking. This is completely normal.



For your own safety and for the proper operation of the vehicle's electrical equipment (lights, windscreen wipers, ABS, etc.), any intervention on the battery (removal, disconnection, etc.) must categorically be performed by a specialist professional.

Risk of serious burns or electric shocks.

The battery is a specific type. Please ensure it is replaced with the same type. Call an approved Dealer.

As the 48 V battery is air-cooled, it is normal for the customer to hear a quiet ventilation noise in certain situations, although this is not always the case.

CLEANING

Bodywork maintenance

A well-maintained vehicle will last longer. It is therefore recommended to maintain the exterior of the vehicle regularly.

Your vehicle has been treated with very effective anti-corrosion products. It is nevertheless subject to various outside influences.

Corrosive agents in the atmosphere

- atmospheric pollution (in built-up and industrial areas);
- saline atmospheres (near the sea, particularly in hot weather);
- seasonal and damp climatic conditions, (e.g.: road salt in winter, water from road cleaners, etc.).

Minor impacts

Abrasive action

Dust and sand in the air, mud, road grit thrown up by other vehicles, etc.

You should take a number of minor precautions in order to safeguard your vehicle against such risks.

You should do the following

Wash your car frequently, **with the engine off**, with cleaning products recommended by the manufacturer (never use abrasive products). Rinse thoroughly beforehand using a jet washer:

- spots of tree resin and industrial pollution;
- mud in the wheel arches and underneath the body which forms damp patches;
- **bird droppings, which cause a chemical reaction with the paint that rapidly discolours paintwork and may even cause the paint to peel off;**

Wash the vehicle **immediately** to remove these marks as it is impossible to remove them by polishing;

- salt, particularly in the wheel arches and underneath the body after driving in areas where the roads have been gritted.

Remove any plant matter (resin, leaves, etc.) from the vehicle regularly.

Observe local regulations about washing vehicles (e.g. do not wash your vehicle on a public highway).

Observe the vehicle stopping distances when driving on gravelled surfaces to prevent paint damage.

Repair, or have repaired quickly, areas where the paint has been damaged, to prevent corrosion spreading.

Remember to visit the body shop periodically in order to maintain your anti-corrosion warranty. Refer to the maintenance document.

When washing the vehicle with a high-pressure cleaning device, please take the following precautions:

- make sure that your vehicle's paintwork, the area or the component that you want to clean is compatible with this type of washing;
- the pressure delivered by the device must be less than 100 bar;
- when washing, position the spray nozzle at least 15 cm from the vehicle and check that the water flow rate is less than 3.30 gal (15 l) per minute;
- do not persist in washing the same area, impacted points or the seals (risk of damage to the paint, seals becoming detached, etc.).

If mechanical components, hinges, etc. have been cleaned, they must be protected again by spraying with products approved by our Technical Department.



We have selected special products to care for your vehicle and you can obtain these from the manufacturer's accessory outlets.

CLEANING

Do not do the following

Wash the vehicle in bright sunlight or freezing temperatures.

Do not scrape off mud or dirt without pre-wetting.

Allow dirt to accumulate on the exterior.

Allow rust to form following minor impacts.

Do not use solvents not approved by our Technical Department to remove stains as this could damage the paintwork.

Do not drive in snow or muddy conditions without washing the vehicle, particularly under the wheel arches and body.



Degrease or clean using high-pressure cleaning equipment or by spraying products not approved by our Technical Department:

- mechanical components (e.g. engine compartment);
- wheels (e.g. braking system components such as brake callipers);
- underbody;
- parts with hinges (e.g. inside the doors);
- painted plastic external fittings (e.g. bumpers).

Doing this could give rise to corrosion or operational faults.

Vehicles with a matte paint finish

This type of paint requires certain precautions.

You should do the following

Wash the vehicle by hand using plenty of water, using a soft cloth or a gentle sponge.

Do not do the following

Use wax-based products (polishing).

Rub too hard.

Wash the vehicle in a roller-type car wash.

Attach stickers to the paintwork (risk of leaving marks).



Wash the vehicle using a high-pressure cleaning device.

Using a roller type car wash

To maintain your vehicle and prevent damage, we advise you to observe the following instructions as well as those indicated by the car wash:

- return the wiper stalk to the off position → 148;
- close all opening elements and windows;

– check that any exterior equipment (additional headlights, etc.) is fitted correctly to the vehicle;

- remove the aerial if present;
- fold in the door mirrors (if possible);
- remove any accessories (roof bars, bicycle rack, etc.).

Note: depending on the vehicle, after washing remember to refit the aerial by screwing it in as far as possible.

Cleaning the headlights, rear lights, sensors and cameras.

Use a soft cloth or cotton wool.

If this does not clean them properly, moisten the cloth with soapy water, then wipe clean with a soft damp cloth or cotton wool.

Finally, carefully dry off with a soft dry cloth.

Do not use alcohol-based cleaning products or utensils such as scrapers.

Cleaning stickers, decorative films, etc.

You should do the following

Use a soft cloth or cotton wool.

Moisten it with soapy water, then always wipe clean with a soft cloth or cotton wool.

CLEANING

Finally, carefully dry off with a soft dry cloth.

Do not do the following

Use alcohol-based cleaning products.

Use utensils (e.g. a scraper).

Rub too hard.



Wash the area using a high-pressure cleaning device.

Interior trim maintenance

A well-maintained vehicle will last longer. It is therefore recommended to maintain the interior of the vehicle regularly.

A stain should always be dealt with swiftly.

Whatever the type of the stain, use **cold (or tepid) soapy water with natural soap**.

Detergents (washing-up liquid, powdered products, alcohol-based products) should not be used.

Use a soft cloth.

Rinse and wipe up excess water.

Multimedia screen

Maintenance of the screen may depend on the type of multimedia equip-

ment. Please refer to the multimedia instructions for further information.

Glass instrument panel

(e.g. instrument panel, clock, exterior temperature display, radio display, etc.)

Use a soft cloth or cotton wool.

If this does not clean them properly, use a soft cloth (or cotton wool) slightly moistened with soapy water and then wipe clean with another soft damp cloth or cotton wool.

Finally, **carefully** dry off with a soft dry cloth.

Do not use products containing alcohol and/or spray fluids on the area.

Seat belts

These must be kept clean.

Use products selected by our Technical Department (approved outlets) or warm, soapy water and a sponge and wipe with a dry cloth.

Detergents or dyes must not be used.

Textiles (seats, door trim, etc)

Vacuum-clean the textiles **regularly**.

Liquid stain

Use soapy water.

Dab lightly (never rub) with a soft cloth, rinse and remove the excess.

Solid or pasty stain

Carefully remove the excess solid or pasty material **immediately** with a spatula (working from the edges to the centre to avoid spreading the stain).

Clean as for a liquid stain.

Special instructions for sweets or chewing gum

Put an ice cube on the stain to solidify it, then proceed as for a solid stain.



For further recommendations for maintaining the interior, and/or for any unsatisfactory results, please see an authorised dealer.

Removal/replacing removable equipment originally fitted in the vehicle

If you need to remove equipment in order to clean the passenger compartment (for example, mats), always ensure that they are correctly refitted and are the right way around (the driver's mat should be fitted on the driver's side, etc.) and fit them with the components supplied with the equipment (for example, the driver mat should al-

CLEANING

ways be fixed using the pre-fitted mounting components).

With the vehicle stationary, always ensure that nothing will impede driving (anything obstructing the pedals, heel wedged by the mat etc.).

Do not do the following

Position objects such as deodorants, scents etc. near air vents as this could damage your dashboard trim.

5



Use high-pressure cleaning equipment or sprays inside the passenger compartment:

- without careful use, this equipment could impair the correct functioning of the electrical or electronic components in the vehicle, or have other detrimental effects.

TYRES

Tyres

Tyre and wheel safety

The tyres are the only contact between the vehicle and the road, so it is essential to keep them in good condition. You must make sure that your tyres conform to local road traffic regulations.

Maintaining the tyres



The tyres must be in good condition and the treads must have sufficient depth: tyres approved by our Technical Department have wear warning strips **1** which are **indicators moulded into the tread at several points**.

When the tyre tread has been worn to the level of the wear indicators, **they become visible 2: it is then necessary to replace your tyres because the tread is 1.6 mm deep at most, resulting in poor road-holding on wet roads.**

An overloaded vehicle, long journeys by motorway, particularly in very hot weather, or continual driving on poorly surfaced minor roads will lead to more rapid tyre wear and affect safety.



Incidents which occur when driving, such as striking the kerb, may damage the tyres and wheel rims, and could also lead to misalignment of the front or rear axle geometry. In this case, have the condition of these checked by an approved dealer.

Tyre pressures

Adhere to the tyre pressures (including the emergency spare wheel). Tyre pressures should be checked at least once a month and additionally before any long journey (refer to the label af-

fixed to the edge of the driver's door)
→ 337.



Incorrect tyre pressures lead to abnormal tyre wear and unusually hot running. These are factors which may seriously affect safety and lead to:

- poor road holding;
- the risk of blow-outs or of throwing a tread.

The pressure depends on the load and the speed of use. Adjust the pressure according to the conditions of use (refer to the label affixed to the edge of the driver's door).

Pressures should be checked when the tyres are cold. Ignore higher pressures which may be reached in hot weather or after driving at high speed.

If tyre pressures cannot be checked when the tyres are **cold, assume an increase of 0.2 to 0.3 bar** (or 3 PSI).

Never deflate a hot tyre.

TYRES



Please be aware that a poorly tightened or missing valve cap can make the tyres less airtight and may lead to pressure loss. Always use valve caps identical to the originals and screw them down fully.



Vehicle fitted with a tyre pressure loss warning system

In the event of under-inflation (puncture, under-inflation, etc.),

the  warning light appears on the instrument panel → 202 → 197.

Changing wheels around

This practice is not recommended.

Emergency spare wheel

→ 343 → 345.

Fitting new tyres



For your safety and to comply with the law. When they need to be replaced, only tyres of the same make, size, type and profile should be used on a single axle.

They must either have a load capacity and speed rating at least equal to those of the original tyres, or conform to those recommended by an approved dealer.

Failure to heed these instructions could endanger your safety and affect your vehicle's roadworthiness.

Risk of loss of control of the vehicle.

Use in winter

Chains

For safety reasons, fitting snow chains to the rear axle is strictly forbidden.

Chains must not be fitted to tyres which are larger than those originally fitted to the vehicle.



Chains may only be fitted to tyres of the same size as those originally fitted to **your vehicle**.

Only certain chains can be fitted to tyres. Consult an approved Dealer.

"Snow" or "Winter" tyres

We would recommend that these be fitted to all **four wheels** to ensure that your vehicle retains maximum adhesion.

Caution: these tyres sometimes have a specific direction of rotation and a maximum speed index which may be lower than the maximum speed for your vehicle.

Studded tyres

This type of equipment may only be used for a limited period and as laid down by local legislation.

It is necessary to observe the speed specified by current legislation.

These tyres must, at a minimum, be fitted to the two front wheels.

TYRES



In all cases, we would recommend that you contact your approved dealer who will be able to advise you on the choice of equipment which is most suitable for your vehicle.

Tyre pressure

Label A



Open the driver's door to read it.

Tyre pressures should be checked when the tyres are cold.

If tyre pressures cannot be checked when the tyres are **cold, the pressure**

values indicated must be increased by 0.2 to 0.3 bar (or 3 PSI). Never deflate a hot tyre.

Tyre pressures must correspond to the current usage of the vehicle (empty, carrying a load, motorway driving, etc.). Observe the tyre pressures (including the emergency spare wheel). These must be checked at least once a month and before any long journey.

Depending on the vehicle, after each reinflation or readjustment of the tyre pressure, you should reset the tyre pressure reference value → 335.



Vehicle fitted with a tyre pressure loss warning system

In the event of under-inflation (puncture, under-inflation etc.),

the  warning light appears on the instrument panel → 202 → 197.

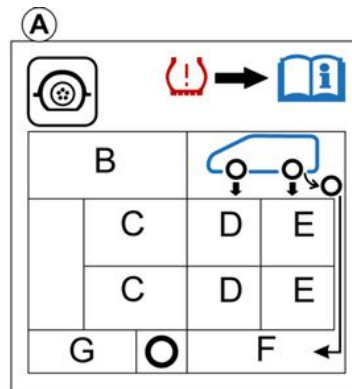

The presence and location of the information on the label depends on the vehicle.

B: size of the tyres fitted to the vehicle.

C: intended driving speed.

D: front tyre pressure.

E: rear tyre pressure.

F: tyre pressure for the emergency spare wheel.

G: size of the emergency spare wheel tyre.

TYRES



Vehicles used fully laden (Maximum Permissible All-up Weight) and towing a trailer

The maximum speed must be limited to **62 mph (100 km/h)** and the tyre pressure increased by **0.2 bar** → 385.

Risk of tyre blowouts.

Tyre safety and chain fitting: for information on maintenance conditions and, depending on the vehicle version, the use of chains → 335.



For your safety and to comply with the law. When they need to be replaced, only tyres of the same make, size, type and profile should be used on a single axle.

They must either have a load capacity and speed rating at least equal to those of the original tyres, or conform to those recommended by an Approved Dealer.

Failure to heed these instructions could endanger your safety and affect your vehicle's roadworthiness.

Risk of loss of control of the vehicle.

Tyre inflation kit



The kit repairs tyres when the tread **A** has been damaged by objects smaller than 4 mm.

It cannot repair all types of puncture, such as cuts larger than 4 mm, cuts in the tyre sidewall **B**, etc.

Ensure also that the wheel rim is in good condition.

Do not pull out the foreign body causing the puncture if this is still in the tyre.

TYRES



Do not attempt to use the inflation kit if the tyre has been damaged as a result of driving with a puncture.

You should therefore carefully check the condition of the tyre sidewalls before any operation. Driving with underinflated, flat or punctured tyres can be dangerous and may make the tyre impossible to repair.

This repair is temporary

A tyre which has been punctured should always be inspected (and repaired, where possible) by a specialist as soon as possible. When taking a tyre which has been repaired using this kit to be replaced, you must inform the specialist.

When driving, vibration may be felt due to the presence of the repair product injected into the tyre.



The kit is only approved for inflating the tyres of the vehicle originally equipped with the kit.

It must never be used to inflate the tyres of another vehicle, or any other inflatable object (rubber ring, rubber boat, etc.).

Avoid spillage on skin when handling the repair product bottle. If droplets do leak out, rinse them off with plenty of water.

Keep the repair kit away from children.

Do not dispose of the empty bottle in the countryside. Return it to your approved dealer or to a recycling organisation.

The bottle has a limited service life which is indicated on its label.

Check the expiry date.

Contact an approved dealer to replace the inflation tube and repair product bottle.

62281

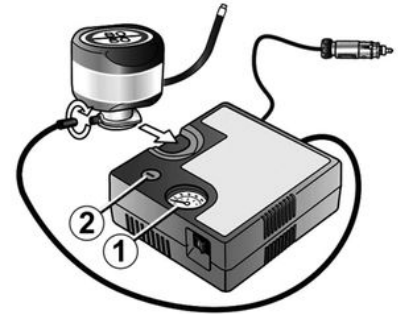

Depending on the vehicle, in the event of a puncture, use the kit located in the boot or underneath the luggage compartment carpet.

The image may not be contractual with the kit supplied with the vehicle.



Before using the kit, park the vehicle at a sufficient distance from traffic, switch on the hazard warning lights, apply the parking brake, ask all passengers to leave the vehicle and keep them away from traffic.

TYRES

Vehicle fitted with a tyre pressure loss warning system

In the event of under-inflation (puncture, underinflation, etc.),

the  warning light appears on the instrument panel → 202 → 197.

With the engine running and the parking brake applied:

- Disconnect any accessories previously connected to the vehicle's accessory sockets;
- **see the information on the inflation kit compressor** located in the vehicle luggage compartment and follow the instructions for use;
- inflate the tyre to the recommended pressure → 337;
- after a maximum of 15 minutes, stop inflating and read the pressure (on the pressure 1));

Note: while the container is emptying (approximately 30 seconds), the pressure gauge 1 will briefly indicate a pressure of up to 6 bar, then the pressure drops.

– adjust the pressure: to increase it, continue inflation with the kit. To reduce it, press the button 2.

If a minimum pressure of 1.8 bar cannot be obtained after 15 minutes, repair is impossible. Do not drive the vehicle. Consult an approved dealer.



If the vehicle is parked on the hard shoulder, you must warn other road users of your vehicle's presence with a warning triangle or with other devices as per the legislation applying to the country you are in.

62281

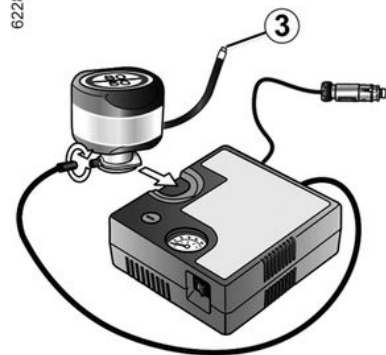

Once the tyre is correctly inflated, remove the kit: unscrew the inflation adapter slowly from the container 3 to prevent any product spatter and store the container in plastic packaging to prevent product leaks.



Nothing should be placed around the driver's feet as during sudden braking such objects may slide under the pedals and obstruct their use.

– Affix the driving recommendation label (located under the container) to the dashboard where the driver can see it.

TYRES

- Put the kit away.
- At the end of this initial inflation operation, air will still escape from the tyre. You must drive a short distance in order to seal the hole.
- Start immediately and drive at a speed of between 12 and 37 mph (20 and 60 km/h) in order to distribute the product evenly within the tyre, then stop driving after 2 miles (3 km) to check the pressure.
- If the pressure is higher than 1.3 bar but lower than the recommended pressure (refer to the label affixed to the edge of the driver's door), you should readjust it. Otherwise, contact an approved dealer: the tyre cannot be repaired.

Precautions when using the kit

The kit should not be operated for more than 15 consecutive minutes. The container must be replaced after the first use even if liquid remains inside.



Please be aware that a poorly tightened or missing valve cap can make the tyres less airtight and may lead to pressure loss. Always use valve caps identical to the originals and screw them down fully.



Following repair with the kit, do not travel further than 124 miles (200 km). In addition, reduce your speed and under no circumstances exceed 50 mph (80 km/h). The sticker, which you must affix in a prominent position on the dashboard, reminds you of this. Depending on the country or local legislation, a tyre repaired with the inflation kit will need to be replaced.

Tools

Access to the tools

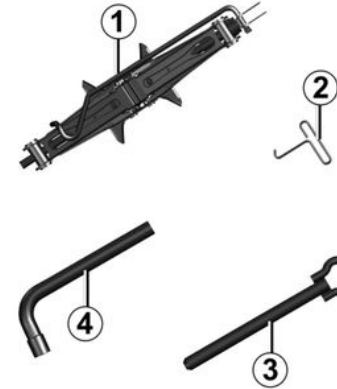

The presence of the tools depends on the vehicle.

Jack 1

To use the jack, loosen the nut **5**. When storing the jack, fold it correctly and replace it in its housing. Tighten the nut **5** to secure the jack.

TYRES



Do not leave the tools unsecured inside the vehicle as they may be projected during braking.

After use, make sure the tools are correctly positioned in their housings: avoid the risk of injury.

Hubcap tool 2

This tool is used to remove the wheel trims.



Towing eye 3

→ 348



Depending on the vehicle, to access the towing ring 3 remove the flap 6.

Wheelbrace 4

This can be used to lock or unlock the wheel bolts and the towing eye 3.



For your safety, the use of a jack not recommended by the manufacturer is strictly prohibited.

The jack is specific to the vehicle and used to change the wheels. Under no circumstances should it be used:

- on another vehicle;
- to carry out a repair;
- to access the underside of the vehicle.

Risk of injury.

Risk of damage to the vehicle.

TYRES

Puncture, emergency spare wheel

In case of puncture

Depending on the vehicle, either an emergency spare wheel or a tyre inflation kit is provided → 338.

 **Vehicle fitted with a tyre pressure loss warning system**

In the event of under-inflation (puncture, under-inflation, etc.),

the  warning light appears on the instrument panel → 202 → 197.



If the vehicle is parked on the hard shoulder, you must warn other road users of your vehicle's presence with a warning triangle or with other devices as per the legislation applying to the country you are in.



Do not touch the exhaust, **risk of burns.**

Emergency spare wheel

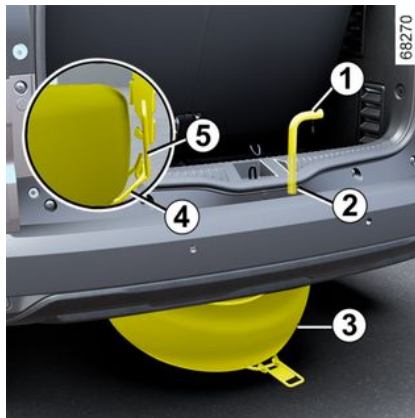

This is placed in the subframe **4** beneath the vehicle.

To take out the emergency spare wheel **3**:

- Open the luggage compartment door;
- loosen the bolt **2** using the wheel-brace **1** → 341;
- release the catch **4** by taking it by the handle **5**;

- remove the emergency spare wheel **3**.

To store the wheel **3** in the sub-frame:

- Store the punctured wheel in the subframe **4**;
- to refit the subframe **4** in its original position, proceed in the reverse order and tighten the bolt using the wheel brace **1** to refit the assembly;
- Check that it is correctly locked in place.



Do not leave the tools unsecured inside the vehicle as they may be projected during braking. After use, make sure the tools are correctly positioned in their mountings: **failure to do so presents a risk of injury.**

TYRES

Warnings



If the spare wheel has been stored for several years, have it checked by your Dealer to ensure that it is safe to use.

Vehicle equipped with an emergency spare wheel that differs from the other four wheels:

- Never fit more than one emergency spare wheel to the same vehicle.
- The punctured wheel is wider than the emergency spare wheel, so the height of the vehicle ground clearance is reduced.
- Replace the emergency spare wheel as soon as possible with a wheel identical to the original one.
- When this is fitted to the vehicle, which must only be a temporary measure, the driving speed must not exceed the speed indicated on the label on the wheel.
- Fitting an emergency spare wheel may alter the way the vehicle usually runs. Avoid sudden acceleration or deceleration and reduce your speed when cornering.
- If you need to use snow chains, fit the emergency spare wheel to the rear axle and check the tyre pressure.

6

TYRES

Changing a wheel

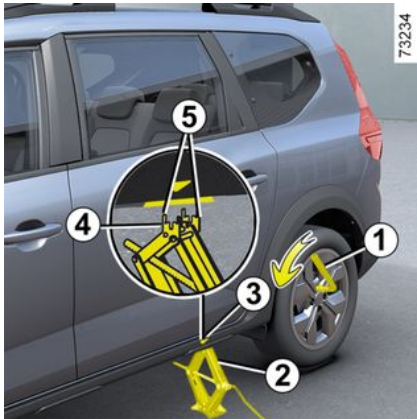

Switch on the hazard warning lights. Keep the vehicle away from traffic and on a level surface where it will not slip. Apply the parking brake and engage a gear (first or reverse, or **P** for automatic transmissions). Ask the passengers to leave the vehicle and to keep away from traffic.

Vehicles equipped with a jack and wheel brace

If necessary, remove the wheel trim. Unlock the wheel bolts using the wheel brace **1**. Position it so as to be able to push from above.



If the vehicle is parked on the hard shoulder, you must warn other road users of your vehicle's presence with a warning triangle or with other devices as per the legislation applying to the country you are in.

Position the jack **2** horizontally. The jack head **must** be lined up with the sill closest to the wheel affected and indicated by the arrow **3**.

Start cranking the jack by hand, positioning the jack support plate **4** in the slightly indented groove underneath the vehicle, located between the two notches **5** and in the direction of the arrow **3**.

Continue to crank the jack so that the baseplate is correctly positioned (it should be underneath the vehicle and aligned with the jack head).

Turn it a few times to lift the wheel off the ground.



To prevent any risk of injury or damage to the vehicle, only crank the jack until the wheel you are replacing is a maximum of 3 centimetres off the ground.

Undo the bolts and take off the wheel. Fit the emergency spare wheel on the central hub and turn it to locate the mounting holes in the wheel and the hub.

If bolts are supplied with the emergency spare wheel, only use these bolts for the emergency spare wheel.

Tighten the bolts, checking that the wheel is correctly positioned on its hub and lower the jack.

With the wheel on the ground, tighten the bolts fully and have the tightness of the bolts checked and the emergency spare wheel pressure checked as soon as possible.

TYRES



Anti-theft bolt

If you use anti-theft bolts, use the instructions on the inside of the wheel trim to position the bolts. (it may not be possible to fit the wheel trim).



Vehicle fitted with a tyre pressure loss warning system

In the event of under-inflation (puncture, under-inflation, etc.),

the  warning light appears on the instrument panel → 202 → 197.



If you have a puncture, replace the wheel as soon as possible. A tyre which has been punctured should always be inspected (and repaired, where possible) by a specialist.



Do not leave the tools unsecured inside the vehicle as they may be projected during braking. After use, make sure the tools are correctly positioned in their housings: avoid the risk of injury.



For your safety, the use of a jack not recommended by the manufacturer is strictly prohibited.

The jack is specific to the vehicle and used to change the wheels. Under no circumstances should it be used:

- on another vehicle;
- to carry out a repair;
- to access the underside of the vehicle.

Risk of injury.
Risk of damage to the vehicle.

Wheel trims, wheel trim – wheel

Central wheel trim with visible wheel bolts



(e.g. wheel trim 1)

The bolts are directly accessible.



Do not leave the tools unsecured inside the vehicle as they may be projected during braking. After use, make sure the tools are correctly positioned in their housings: avoid the risk of injury.

TYRES

Central wheel trim with concealed wheel bolts

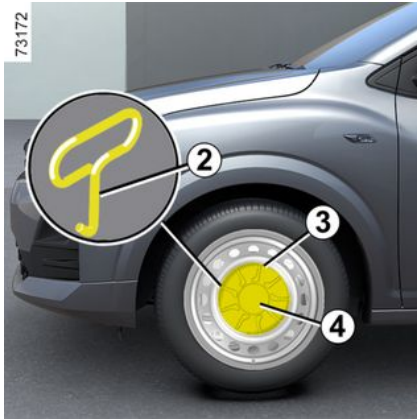

(e.g. wheel trim **4**)

Remove it using the hubcap tool **2**, inserting the tool into the recess **3** provided.

To refit it, turn it so that it is aligned with the rim and clip it in place.

Wheel trim with visible wheel bolts

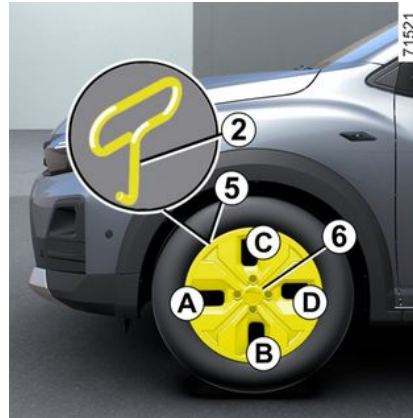

(e.g. wheel trim **6**)

Remove it using the hubcap tool **2**, inserting the tool into the valve recess **5**.

To refit it, align it with the valve **5**.

Push the retaining hooks in fully, starting on the side of valve **A**, followed by **B** and **C**, finishing at the side opposite valve **D**.

BREAKDOWN RECOVERY

Towing: breakdown

Before towing, set the gearbox to the neutral position (**N** position on vehicles fitted with an automatic gearbox),

then wait around one minute (on the Hybrid version, unlock the steering column then release the parking brake.

Steering column unlocking

Insert the key into the ignition, turn it to the "On" position **ON 2** or, depending on the vehicle, with the card present in the passenger compartment, press the engine start button **for approximately two seconds** without pressing the brake pedal → **162** → **164**

Set the lever to neutral (position **N** for vehicles equipped with an automatic gearbox).

On the E-tech full hybrid version, wait approximately one minute before towing.

The steering column unlocks and the accessory functions are powered: you can use the vehicle's lights (direction indicator lights, brake lights). At night, the vehicle must have its lights on.

Depending on the vehicle, the "Permanent IGN activated" message appears on the instrument panel.

If the driver's seat belt is fastened, unfasten it.

Open the driver's door.

Release the parking brake while press-

ing the brake pedal → **180**. The  warning light disappears from the instrument panel or, depending on the vehicle, and the "Parking brake loose" message is displayed on the instrument panel).

Close the driver's door and do not lock the vehicle (depending on the vehicle, "Permanent IGN activated" mode must remain activated).

On the Hybrid version, wait approximately one minute before towing.

Depending on the vehicle, once the towing is complete, press the engine start button for more than two **seconds** without pressing the brake pedal (risk of battery discharging). The "Permanent IGN activated" message disappears from the instrument panel.

The speed specified by current legislation for towing must always be observed. If you are driving the towing vehicle, do not exceed the maximum towing weight for your vehicle → **385**.

Towing a vehicle with an automatic transmission, mechanical lever

Transport the vehicle on a trailer or tow it with the front wheels off the ground.

Under exceptional circumstance, you may tow the vehicle with all four wheels on the ground, only going forward, with the gear lever in the neutral **N** and over a maximum distance of 50 miles (80 km) at a maximum speed of 16 mph (25 km/h).



Leave the card in the vehicle during towing.
Risk of the steering column locking.

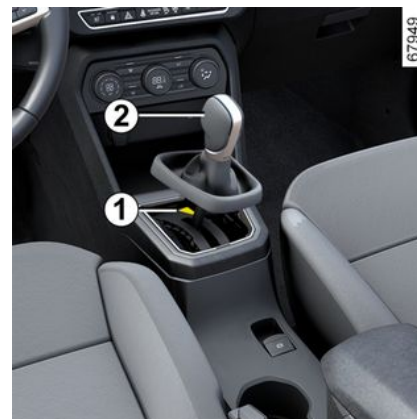

When setting off, if the lever is locked in position **P** when you press the brake pedal (e.g. battery fault), it is possible to manually release the lever to un-

BREAKDOWN RECOVERY

block the drive wheels. To do this, unclip the base of the gaiter and press the **1** push button while simultaneously pressing the **2** button on the lever to unlock the lever and shift to position **N**.

Contact your Approved Dealer as soon as possible.

Only use the front 3 and rear 7 towing points (never use the driveshafts or any other part of the vehicle). These towing points may only be used for pulling. They must never be used for lifting the vehicle directly or indirectly.



When the engine is stopped, steering and braking assistance are no longer provided.

Access to towing points

Front towing point

(depending on the vehicle)

Press area **A** to extract the upper section of the flap

Tighten the towing eye 4 to the maximum: first by hand until it stops, then finish by locking it using the wheel brace.

Use only the towing ring **4** and the wheelbrace → **341**.

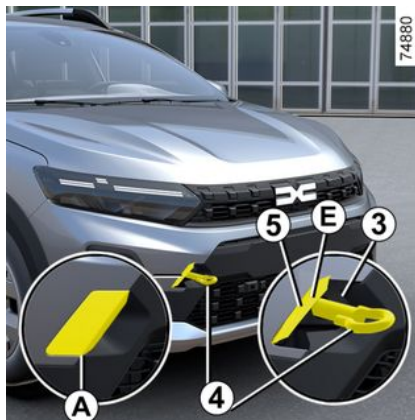

Rear towing point

(depending on the vehicle)

Press area **C** to remove the upper section of the flap, then insert a flat-blade tool into area **D** to pry open the flap **6**.

Tighten the towing eye 4 to the maximum: first by hand until it stops, then finish by locking it using the wheel brace.

Use only the towing ring **4** and the wheelbrace → **341**.

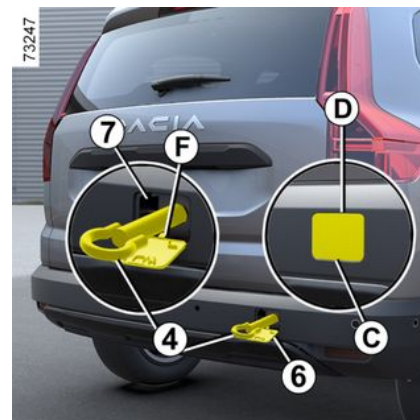

Refitting flap 5 and 6.

After use, loosen the towing eye **4** and press the flap **5** in area **E** to lock it.

- Loosen the towing eye **4**;
- place the hook **F** in its housing;
- press on area **G**

BREAKDOWN RECOVERY



Ensure that the tow eye is screwed in correctly.
Risk of losing the towed object.



- Use a rigid tow bar. If a rope or cable is used (where the law allows this), the vehicle being towed must be able to brake.
- a vehicle must not be towed if it is not fit to be driven.
- avoid accelerating or braking suddenly when towing, as this may result in damage being caused to the vehicle.
- In any case, it is advisable not to exceed **16 mph (25 km/h)**.



Do not leave the tools unsecured inside the vehicle as they may be projected during braking.



When the engine is stopped, steering and braking assistance are no longer provided.



Do not remove the key from the ignition switch, or leave the card in the vehicle during towing (depending on the vehicle).
Risk of the steering column locking.

Towing or recovering your vehicle with a platform truck

71527



BREAKDOWN RECOVERY



71526



It is strictly prohibited to tow your vehicle with the front wheels on the ground. Before towing your vehicle or transporting it on a flatbed, observe the following instructions:

- you must abide by the towing conditions that apply in the country where you are located;
- with the card in the passenger compartment, press the engine start button;
- set the gear control to the **N** position: the parking brake is released;
- press the engine Start button for more than two seconds. The accessories functions are powered: you can use the vehicle lighting functions (hazard warning lights, brake lights, etc.). At night the vehicle lights must be on;

- once you have finished towing, press the engine start button for more than two seconds (risk of discharging the battery).

Battery: breakdown recovery

To avoid all risk of sparks:

- Ensure that any power consumers (courtesy lights, etc.) are switched off before disconnecting or reconnecting a battery;
- when charging, switch off the charger before connecting or disconnecting the battery;
- do not place any metal objects on the battery as this may create a short circuit across the terminals;
- always wait at least one minute after the engine has been switched off before disconnecting a battery;
- make sure that you reconnect the battery terminals after refitting.



Before carrying out any action in the engine compartment, you must switch off the ignition

→ 162 or → 164.

Connecting a battery charger

The battery charger must be compatible with a battery with nominal voltage of 12 volts.

Do not disconnect the battery while the engine is running. **Follow the instructions given by the manufacturer of the battery charger you are using.**



Special procedures may be required to charge some batteries. Contact your approved dealer.

Avoid all risk of sparks which may cause an immediate explosion, and charge the battery in a well ventilated area.

Risk of serious injury.

BREAKDOWN RECOVERY



Handle the battery with care as it contains sulphuric acid which must not come into contact with the eyes or skin. If it does, wash the affected area with plenty of cold water. If necessary, consult a doctor.

Keep any flames, red hot objects or sparks away from the battery components (**risk of explosion**). Please note when working close to the engine that it may be hot. The engine cooling fan may also

start at any moment. The  label in the engine compartment reminds you of this.

Risk of injury.

Starting the vehicle using the battery from another vehicle

If you have to use the battery on another vehicle to start your vehicle, obtain suitable jump leads (with a large cross section) from an approved dealer or, if you already have jump leads, ensure that they are in perfect condition.

The two batteries must have an identical nominal voltage: 12 V. The battery supplying the current should have a capacity (amp-hours, Ah) which is at least the same as that of the discharged battery.

Ensure that there is no contact between the two vehicles (risk of short circuit when the positive terminals are connected) and that the discharged battery is properly connected. Switch off your vehicle ignition.

Start the engine of the vehicle supplying the current and run it at an intermediate engine speed.

Note: on the Hybrid version, as the battery cannot be directly accessed, it is necessary to use the remote terminals located in the engine compartment.



Do not use your Hybrid vehicle to restart a "12 V" battery in another vehicle.

The electrical power in the secondary "12 V" battery of an Hybrid vehicle is not sufficient for this operation.

Risk of damage to the vehicle.

"12 V" battery in the engine compartment

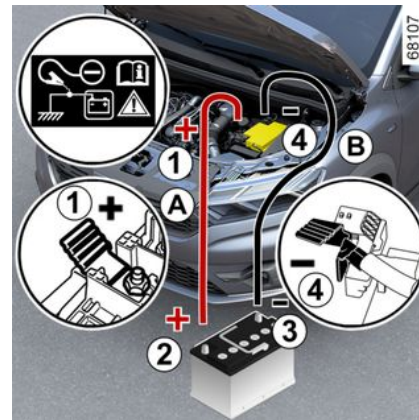

(combustion version)

Attach the positive cable (+) **A** to terminal (+) **1** of the discharged battery, then to terminal (+) **2** of the battery supplying the current.

Attach the negative cable (-) **B** to terminal (-) **3** of the battery supplying the current and then to terminal (-) **4** or, depending on the vehicle, (-) **5** of the discharged battery.

BREAKDOWN RECOVERY

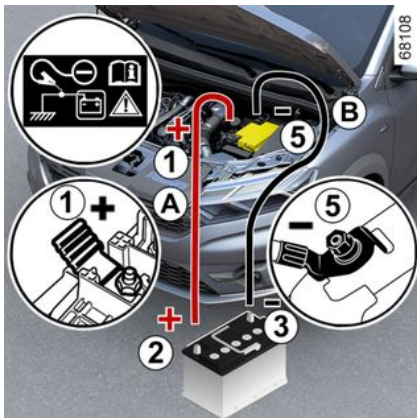

Start the engine as normal. As soon as the engine starts running, disconnect cables **A** and **B** in reverse order (**4 - 3 - 2 - 1**) or, depending on the vehicle, (**5 - 3 - 2 - 1**).



Ensure that there is no contact between cables **A** and **B** and that positive cable **A** is not in contact with any metallic component in the vehicle supplying the current.

Risk of serious injury and/or damage to the vehicle.



Depending on the vehicle, in the event of a battery fault (disconnected, discharged battery, etc.), the steering wheel angle must be reset → 138.

The "12 V" battery at the rear of the vehicle

(Hybrid version)

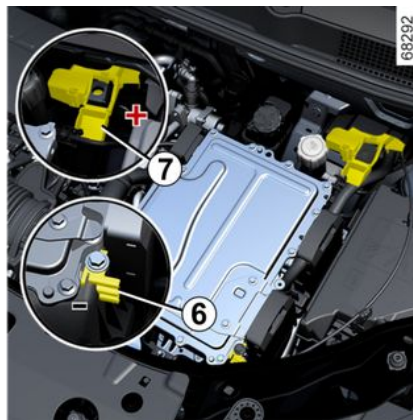

The battery is not directly accessible. Use **terminal 6 (-)** and **terminal 7 (+)** in the engine compartment.



Note: open the cover **8** of terminal **6** (+) by pressing the button **9** in the direction indicated by the arrow.

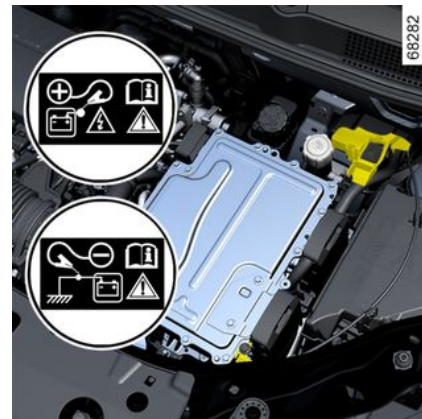

BREAKDOWN RECOVERY



It is forbidden to disconnect the positive cable in the engine compartment.

Risk of the engine starting inadvertently.
Risk of burns by projection of sparks.

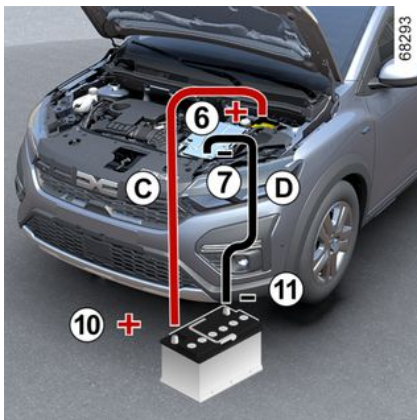

Attach the positive cable **C** to **terminal 6 (+)**, then to **terminal 10 (+)** of the battery supplying the current.

Attach the negative cable **D** to **terminal 11 (-)** of the battery supplying the current and then to **terminal 7 (-)**.

Press the brake pedal and the Start button. Once the engine has started, disconnect cables **C** and **D** in reverse order (**6 - 10 - 11 - 7**).

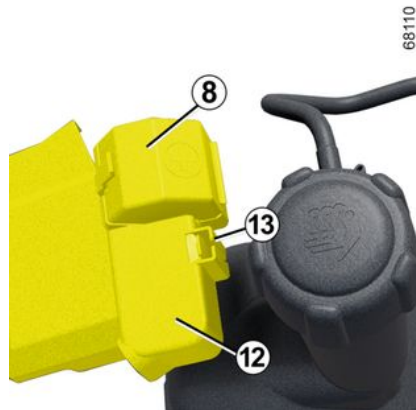

Each time you have used the cover **8**, check that the cover of terminal **13** is attached correctly to its tab **12**.



Ensure that there is no contact between cables **C** and **D** and that the positive cable **C** is not in contact with any metallic component in the vehicle supplying the current.

Risk of injury and/or damage to the vehicle.

HEADLIGHTS, LIGHTS: REPLACING BULBS

Exterior lighting: replacing bulbs

Front headlights: replacing the bulbs

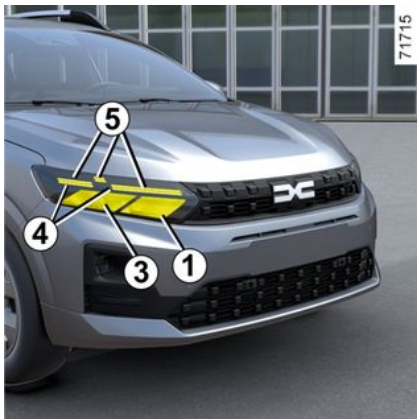

Main beam headlight 1

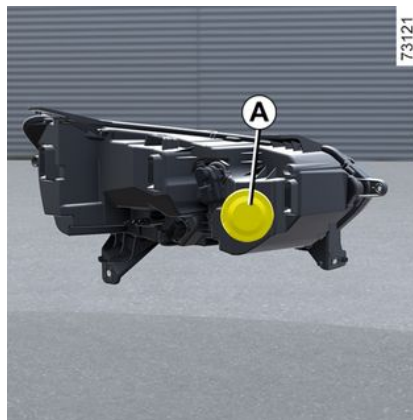

Remove the cover **A**.

Unclip the connector **2**, remove the assembly from its housing and take out the bulb.

Bulb type: H7.

Before replacing the bulb, make a careful note of its position in its housing. After changing it, check that the replacement bulb is in exactly the same position in the housing. Clip the cover in place.

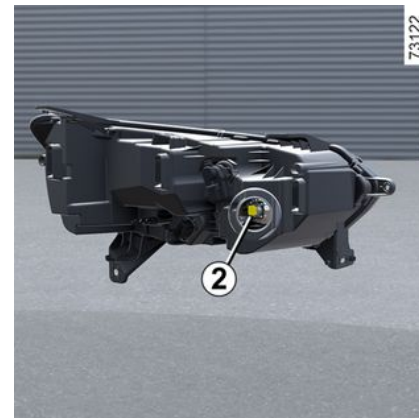

Dipped beam headlight 3 (LED)

Consult an approved Dealer.

Daytime running light/side light 4 (LED)

Consult an approved Dealer.

Direction indicator light 5 (LED)

Consult an approved Dealer.

HEADLIGHTS, LIGHTS: REPLACING BULBS



Please note when working close to the engine that it may be hot. The engine cooling fan may also start at any moment. The



label in the engine compartment reminds you of this.

Risk of injury.

Front fog lights 6



Because of their reduced accessibility, **we advise you to have your bulbs replaced by an approved Dealer.**



- Access the bulb holder by unclipping the flap 7;
- turn the bulb holder by a quarter of a turn;
- remove the bulb.

Bulb type: H16LL.

Additional lights

If you wish to fit fog lights to your vehicle, please consult an authorised dealer.

Rear and side lights

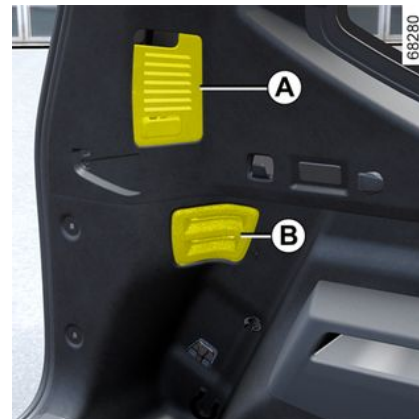

Side/fog lights, direction indicator lights, brake lights and reversing lights

(depending on the vehicle)

Open the luggage compartment door and remove covers **A** and **B**.

HEADLIGHTS, LIGHTS: REPLACING BULBS

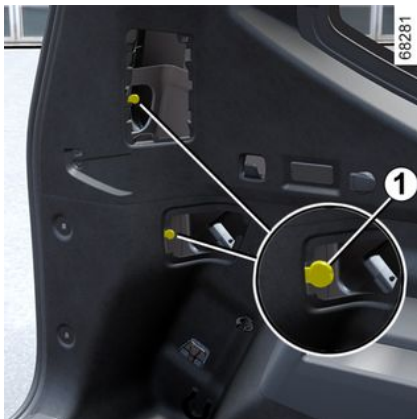

Loosen bolts **1** and **2** (using a screwdriver or similar tool), then remove the rear light unit from outside the vehicle.

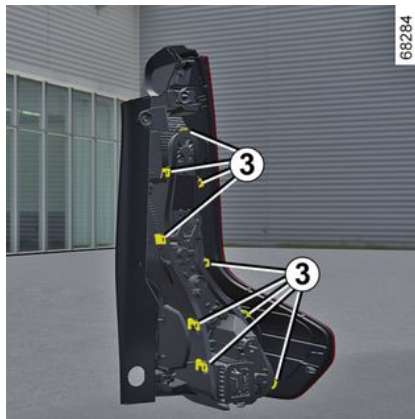

Pull the tabs **3** to unclip the bulb holder.

To refit it, carry out the above operations in reverse order.

Check the tabs are correctly locked in position.

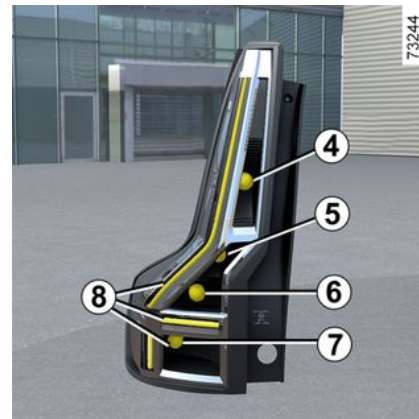

4. Brake light

Bulb type 4: P21W.

5. Reversing light

Bulb type 5: P21W.

6. Direction indicator light

Bulb type 6: PY21W

7. Side light/fog light

(depending on the vehicle)

Bulb type 7: P21W.

8. Daytime running light/side light 8 with LED

HEADLIGHTS, LIGHTS: REPLACING BULBS



High level brake light 9

Using a flat-blade screwdriver or similar tool, carefully unclip the brake light 9 while pressing on the upper surface of the brake light (movement **C**). Disconnect the brake light.



Access the bulb 10.

Bulb type 10: W16W.

To refit, position the brake light on the spoiler.

Press the upper edge of the part (movement **D**) then push the screen of the light in the areas where the clips are located until it clicks (movement **E**).

However, because of their reduced accessibility, **we advise you to have your bulb replaced by an approved Dealer.**



HEADLIGHTS, LIGHTS: REPLACING BULBS

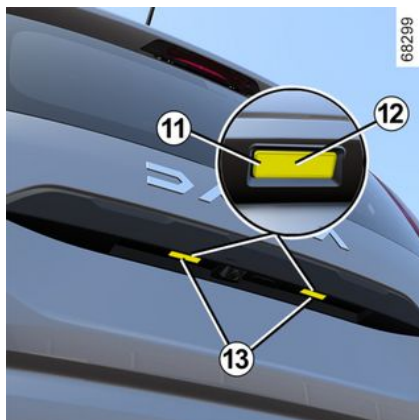

Number plate lights 13

Unclip the light 13 by pressing the tab 11 using a flat-blade screwdriver or similar tool.

Unclip the lens 12 and remove the bulb 14.

Bulb type: W5W.

LED number plate lights 13

(depending on the vehicle)

Consult an approved Dealer.

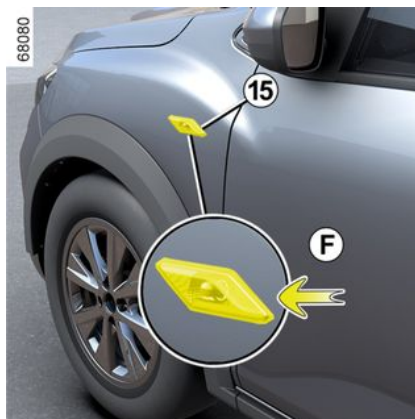

Indicator lights 15

Unclip the direction indicator light 15 using a flat-blade screwdriver or sim-

ilar tool positioned at **F** to lever the direction indicator light towards the outside of the vehicle.

Make a quarter of a turn (movement **G**) on the bulb holder 16 and remove the bulb 17 (movement **H**).

Bulb type: WY5W.

Replace the bulb and refit the direction indicator light.

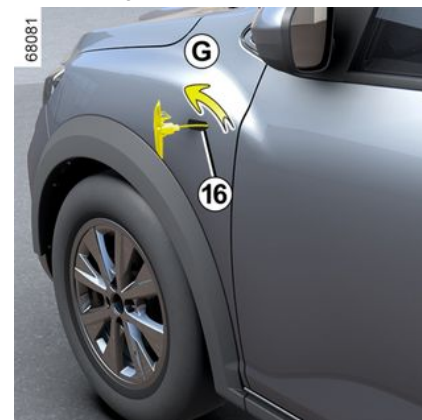

HEADLIGHTS, LIGHTS: REPLACING BULBS

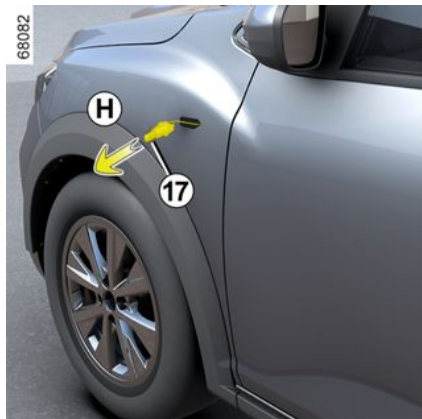

Interior lighting: changing bulbs

Front ceiling light 1



- Unclip the lens **2** using a tool such as a flat-head screwdriver positioned at **A**;
- unclip and release the bulb holder **3** using the tabs **4**;
- remove the bulb concerned.

Bulb type 5: W5W.



Refitting

- Clip the lens **2** onto the bulb holder **3**;
- clip in the courtesy light **1** until you hear the click;
- ensure that the interior lights are properly positioned and locked into place.



The bulbs are under pressure and may break when replaced.
Risk of injury.

HEADLIGHTS, LIGHTS: REPLACING BULBS



- Unclip the lens 7 using a tool such as a flat-head screwdriver positioned at B;
- unclip and release the bulb holder 8 using the tabs 9;
- remove the bulb concerned.

Bulb type 10: W5W.

Refitting

- Clip the lens 7 onto the bulb holder 8;
- clip in the reading spot light unit 6 until it clicks;
- make sure that the reading spots block is correctly positioned and locked into place.

Front reading spot lights 6

(depending on the vehicle)

HEADLIGHTS, LIGHTS: REPLACING BULBS

6

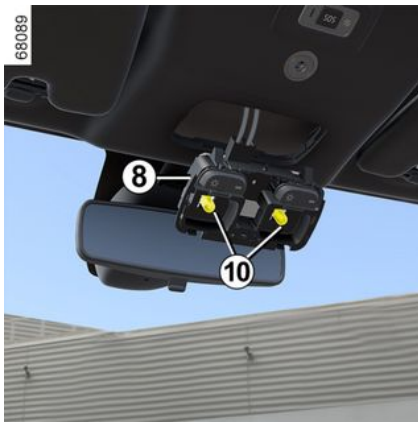

Rear reading spot light 11

(depending on the vehicle)

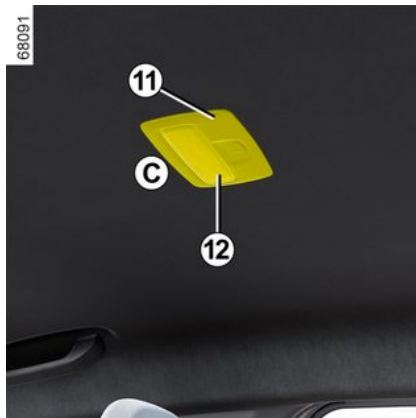

- Unclip the lens **12** using a tool such as a flat-head screwdriver positioned at **C**;
- unclip and release the bulb holder **13** using the tabs **14**;
- remove the bulb concerned.

Bulb type 15: W5W.



Refitting

- Clip the lens **12** onto the bulb holder **13**;
- clip in the reading spot light unit **11** until you hear the click;
- make sure that the reading spots block is correctly positioned and locked into place.

HEADLIGHTS, LIGHTS: REPLACING BULBS

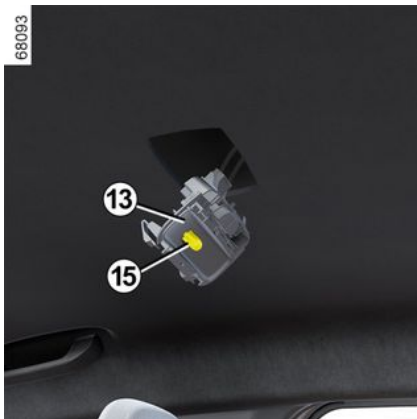

Rear courtesy light 16
(depending on the vehicle)

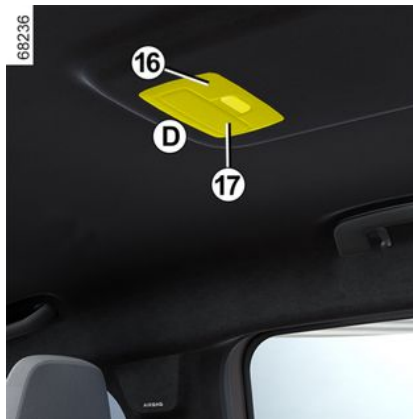

- Unclip the lens **17** using a tool such as a flat-head screwdriver positioned at **D**;
- unclip and release the bulb holder **18** using the tabs **19**;
- remove the bulb concerned.

Bulb type 20: W5W.



Refitting

- Clip the lens **17** onto the bulb holder **18**;
- clip in the rear courtesy light unit **16** until it clicks;
- make sure that the reading spots block is correctly positioned and locked into place.

HEADLIGHTS, LIGHTS: REPLACING BULBS

6



Rear courtesy light 21
(depending on the vehicle)

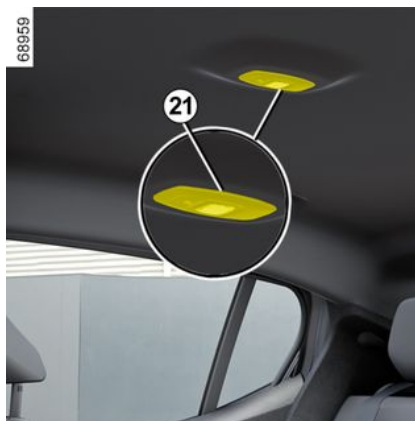

Using a flat-blade screwdriver or similar, unclip the rear courtesy light **21** by pressing the tab located on one side of the courtesy light to access the bulb.

Bulb type 21: W5W.

Glovebox light 22
(depending on the vehicle)

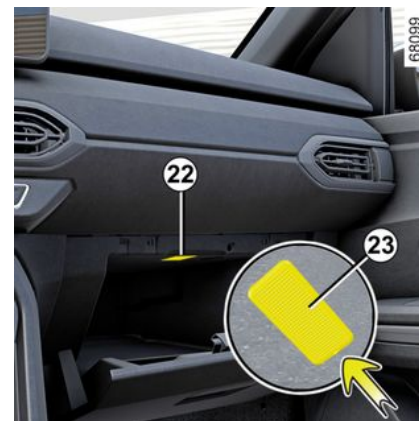

Unclip the light **22** by using a flat-blade screwdriver or similar tool to press on the tab **23** to move the light towards the inside of the box.

Disconnect the light.

Bulb type 22: W5W.

Luggage compartment light 24

Unclip the light **24** by using a flat-blade screwdriver or similar tool to press on the tab **25** to move the light towards the inside of the luggage compartment.

Disconnect the light.

Release the lens **26** and access the bulb **27**.

Bulb type 27: W5W.

HEADLIGHTS, LIGHTS: REPLACING BULBS

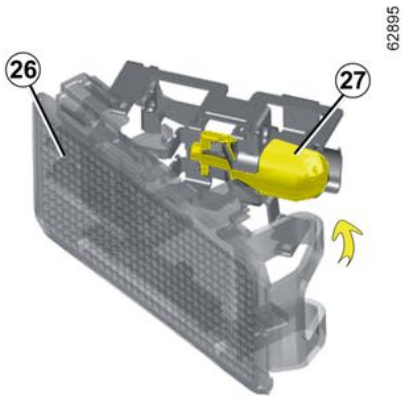
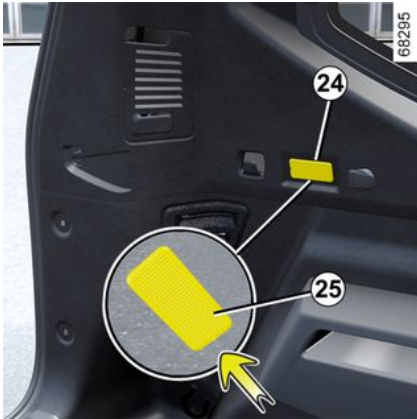

WIPER BLADES: REPLACEMENT

Replacing windscreen wiper blades 2



To replace the wipers, first put them in the service position **B**.

Engine running or ignition on:

- move the stalk **1** twice in succession to position **A** (single sweep): the wiper blades will stop in position **B** away from the bonnet;
- lift the wiper arm **3**;
- lower the tab **4** and remove the blade **2**.

Refitting

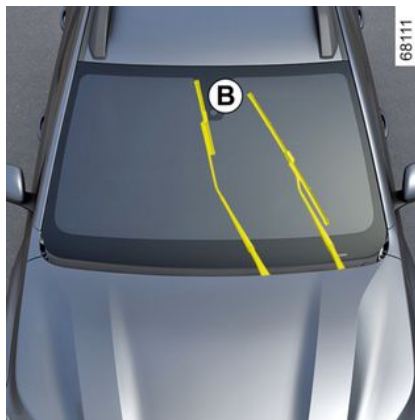

To refit the wiper blade **2**, insert it into its housing in the arm **3**, then clip it until you hear a click. Make sure that the blade is correctly locked in position.

To return the blades to the lowered position, make sure that the blades are folded down onto the windscreen then set the stalk **1** to position **A** (single sweep): the windscreen wiper blades will fold into the bonnet.

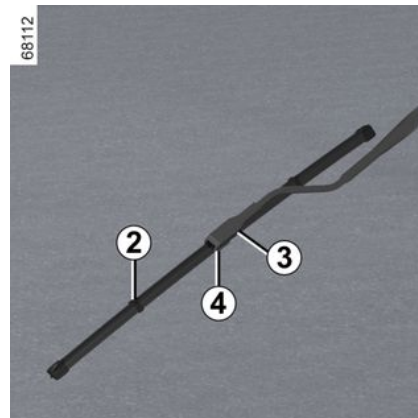

 Check the condition of the wiper blades. You are responsible for their service life:

- clean the blades, windscreen and rear screen regularly with soapy water;
- do not use them when the windscreen or rear screen is dry;
- separate them from the windscreen or rear screen when they have not been used for a long time.

WIPER BLADES: REPLACEMENT

Rear screen wiper blade 5

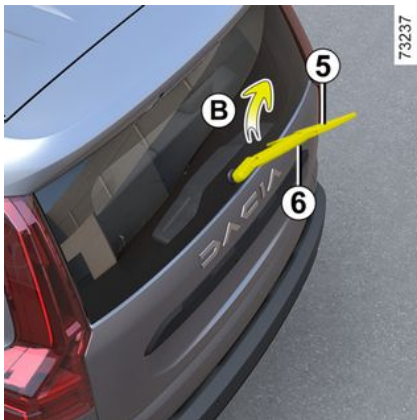

The stalk in the off position (deactivated):

- lift the wiper arm **6**;
- pivot the blade **5** (movement **B**) until it unclips;
- remove the blade by pulling it.

Refitting

To refit the wiper blade, proceed in the reverse order to removal. Make sure that the blade is correctly locked in position.



– In frosty weather, make sure that the wiper blades are not stuck by ice (to avoid the risk of the motor overheating).

– Check the condition of the wiper blades. Replace the wiper blades as soon as they begin to lose efficiency (approximately once a year).

Whilst changing the blade, take care not to drop the arm onto the window after it has been removed as this may break the window.



Before changing the rear wiper blade, make sure the stalk is in the off position (deactivated).

Risk of injury.

FUSES

Fuse box



If any electrical component does not work, check the condition of the fuses.

Unclip the flap **A** using the notch **1** or, depending on the vehicle, unclip the flap **B** using the notch **2**.

Tweezers 3

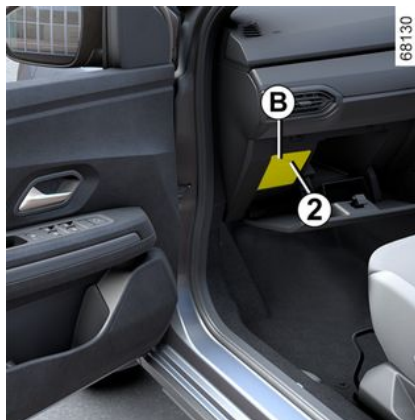

Detach the fuse using the tweezers **3**, located on the back of flap **A** or **B**.

To remove the fuse from the puller, slide the fuse to the side.

It is not advisable to use the free fuse locations.



To comply with current legislation, or as a precaution, you can obtain an emergency kit containing a set of spare bulbs and fuses from your approved Dealer.

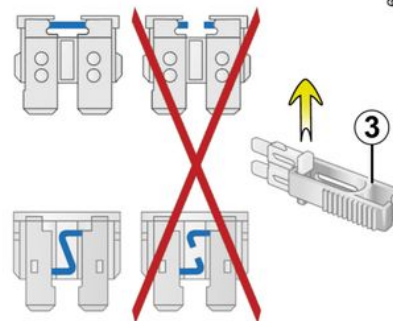

Check the fuse in question and, **if necessary, replace it with a fuse of the same rating as the original.**

If a fuse is fitted with too high a rating, it may cause the electrical circuit to overheat (risk of fire) in the event of an item of equipment using an excessive amount of current.

LPG fuse in the fuse box **A** or **B**

LPG fuse: LPG circuit shut-off or LPG circuit and petrol circuit shut-off.

FUSES



Please note when working close to the engine that it may be hot. The engine cooling fan may also start at any moment. The



label in the engine compartment reminds you of this.

Risk of injury.

Allocation of fuses

(the presence of certain fuse depends on the vehicle equipment level)



Horn



Front window winder, electric front windows



Rear electric windows



Brake lights, UCH



Courtesy light, luggage compartment light



Multimedia port



Towbar socket



Windscreen washer pump, steering column controls



Direction indicator lights, UCH



Cigarette lighter, accessories socket



Heated rear view mirrors



Rear view electric mirrors control



GPL LPG



Use the fuse allocation label in the storage compartment to identify the fuses.

Certain fuses should only be replaced by a qualified professional. These fuses are not listed on the label.

Only change the fuses represented on the label.

FITTING A RADIO



If your vehicle is not fitted with an audio system, one can be fitted and locations have been provided for:

- the front speakers **1** and **2**;
- the rear speakers **3**.

To install any equipment, please consult an approved dealer.

- i** – In all cases, follow the manufacturer's instructions carefully.
- – The specifications of the brackets and wires (available from our network) vary depending on the equipment level of your vehicle and the type of radio. Consult an approved Dealer to find out the correct part number.
 - No work may be carried out on the vehicle's electrical or radio circuits, except by approved dealers: an incorrectly connected system may result in damage to the electrical equipment and/or the components connected to it.

INSTALLATION AND USE OF ACCESSORIES



Electrical and electronic accessories

Before installing this type of accessory (particularly for transmitters/receivers: frequency bandwidth, power level, position of the aerial, etc.), make sure it is compatible with your vehicle. Contact an approved dealer.

Before connecting an accessory to a socket, please ensure that it does not exceed the maximum power authorised for the socket → 301 → 291. **Fire hazard.**

No work may be carried out on the vehicle's electrical and/or electronic circuits, except by a qualified professional. In fact, an incorrect connection and/or the installation of electrical/electronic accessories not approved by the manufacturer could lead to:

- damage to the electrical and/or electronic equipment;
- damage to the components connected to it;
- the collection and use of vehicle data;
- an invasion of privacy (modification, deletion or unwarranted access to personal data);
- cancellation of the authorisation for entry into service.

Risk of serious accidents. Risk of invasion of privacy.

If you have electrical equipment fitted in future, make sure that you are notified of the rating and position of the corresponding fuse.

Using the diagnostic socket

The use of electronic accessories on the diagnostic socket may cause serious disturbance to the vehicle's electronic systems and/or cause invasion of privacy (modification, deletion or unwarranted access to personal data). For your safety, we recommend that you only use electronic accessories approved by the manufacturer: consult an approved dealer. **Risk of serious accidents. Risk of invasion of privacy.**

Fitting aftermarket accessories

If you wish to install accessories on the vehicle: consult an approved dealer. Also, to ensure the correct operation of your vehicle, and to avoid any risk to your safety, we recommend that you use only accessories specifically designed for your vehicle, which are the only accessories for which the manufacturer will provide a warranty.

If you are using an anti-theft device, only attach it to the brake pedal.

Driver obstruction

INSTALLATION AND USE OF ACCESSORIES

On the driver's side, only use mats suitable for the vehicle, attached with the pre-fitted components, and check the fitting regularly. Do not lay one mat on top of another. **There is a risk of wedging the pedals.**

OPERATING FAULTS

The following advice will enable you to carry out quick, temporary repairs. For safety reasons, you should always contact an approved Dealer as soon as possible.

Using the card	POSSIBLE CAUSES	ACTION REQUIRED
The card does not lock or unlock the doors.	Card battery is flat.	Replace the battery. You will still be able to lock/unlock, and start your vehicle → 51 and → 162 or → 164.
	Use of devices operating on the same frequency as the card (mobile phone, etc.).	Stop using the devices or use the built-in key → 51.
	Vehicle located in a high electromagnetic radiation zone.	Use the key that is built into the card → 51.
	Vehicle battery flat.	
	The "Place card on zone + START" message appears on the instrument panel.	Place your card on the placement area → 164 then press the button START.
	The vehicle is started.	While the engine is on, it is not possible to lock/unlock using the card. Turn off the ignition.
	Desynchronisation of the card.	Unlock the driver's door by inserting the card's built-in key into the door lock → 51, then place the card on the placement area → 164 and press the START button to synchronise the card.

Using the remote control	POSSIBLE CAUSES	ACTION REQUIRED
The remote control does not lock or unlock the doors.	The remote control battery is flat.	Use the emergency key.
	Use of devices operating on the same frequency as the remote control (mobile phone, etc.).	Stop using the devices or use the key.
	Vehicle located in a high electromagnetic radiation zone.	Replace the battery. You will still be able to lock, unlock and start your vehicle → 51 and → 162 or → 164.

OPERATING FAULTS

Using the remote control	POSSIBLE CAUSES	ACTION REQUIRED
	<p>Discharged battery.</p> <p>The vehicle is started.</p> <p>Desynchronisation of the remote control.</p>	<p>While the engine is on, it is not possible to lock/unlock using the key. Turn off the ignition.</p> <p>Unlock the driver's door using the key in the door lock, then start the engine to synchronise the remote control.</p>
The starter is activated	POSSIBLE CAUSES	ACTION REQUIRED
The instrument panel indicator lights are weak or fail to light up and the starter does not turn.	<p>Battery terminals not tight, battery terminals disconnected or oxidised.</p> <p>Battery discharged or not operational.</p> <p>Faulty circuit.</p>	<p>Retighten, reconnect or clean them if they are oxidised.</p> <p>Connect another battery to the faulty battery → 351 or replace the battery if necessary.</p> <p>Do not push the vehicle if the steering column is locked.</p> <p>Consult an approved Dealer.</p>
The engine will not start.	<p>Starting conditions are not fulfilled.</p> <p>The "hands-free" card does not work.</p>	<p>→ 162 or → 164.</p> <p>Place the card in the recess provided for this purpose on the centre console.</p> <p>→ 162 or → 164.</p>
With the vehicle stationary, engine cold, the engine's idle speed is high.	Petrol version, this is not necessarily a fault. This may be caused by the increase in the engine temperature.	The engine's idle speed should decrease after about one minute. Otherwise, this may be caused by another fault. Call an approved Dealer.
The engine cannot be switched off.	Card not detected.	<p>Place the card in the recess provided for this purpose on the centre console.</p> <p>Press and hold the start button.</p>

OPERATING FAULTS

The starter is activated	POSSIBLE CAUSES	ACTION REQUIRED
	Electronic fault.	Press the start button 3 times quickly or press and hold.
The steering column remains locked.	Steering wheel locked.	Move the steering wheel while pressing the engine start button (or, depending on the vehicle, while using the ignition key) → 162.
	Faulty electrical circuit.	Consult an approved Dealer.

On the road	POSSIBLE CAUSES	ACTION REQUIRED
Vibrations.	Tyres not inflated to the correct pressure, incorrectly balanced or damaged.	Check the tyre pressures: if this is not the cause, have their condition checked by an approved Dealer.
White smoke from the exhaust.	In the diesel version, this is not necessarily a fault. Smoke may be caused by particle filter regeneration. Petrol version, this is not necessarily a fault. Depending on the climate conditions (cold, humidity etc.), smoke may be produced under hard vehicle acceleration.	→ 185 Reduce the engine speed and avoid sudden acceleration to gradually make the smoke disappear. Otherwise, this may be caused by another fault. Consult an approved Dealer.
Smoke under the bonnet.	Short-circuit or cooling system leak.	Stop, switch off the ignition, stand away from the vehicle and contact an approved Dealer.
The oil pressure warning light comes on:		
while cornering or braking	The level is too low.	Top up engine oil → 320 .
is slow to go out or remains lit up under acceleration.	Loss of oil pressure.	Stop the vehicle and contact an approved Dealer.

OPERATING FAULTS

On the road	POSSIBLE CAUSES	ACTION REQUIRED
Steering becomes heavy.	Assistance overheating. Fault with the electric assistance motor. Fault in the assistance system.	Drive carefully at reduced speed, be aware of the level of force in the steering wheel needed to turn the wheels. Consult an approved Dealer.
The engine is overheating. The coolant temperature indicator is in the warning zone and warning light	Engine cooling fan not working. Coolant leaks.	Stop the vehicle, switch off the engine and contact an approved Dealer. Check the coolant reservoir: it should contain fluid. If there is no coolant, consult an approved Dealer as soon as possible.
STOP comes on.		
Coolant boiling in the coolant reservoir.	Mechanical fault: damaged cylinder head gasket.	Stop the engine. Call an approved Dealer.



Radiator: in the event of a significant lack of coolant, remember that you must never top it up using cold coolant while the engine is very hot. After any procedure on the vehicle which has involved even partial draining of the cooling system, it must be refilled with a new mixture prepared in the correct proportions. Reminder: only products approved by our Technical Department may be used for this purpose.

Electrical equipment	POSSIBLE CAUSES	ACTION REQUIRED
The wipers do not work.	Wiper blades stuck. Faulty electrical circuit. Fuse damaged.	Free the blades before using the wipers. Consult an approved Dealer. Replace the fuse or have it replaced ➔ 368.

OPERATING FAULTS

Electrical equipment	POSSIBLE CAUSES	ACTION REQUIRED
The wiper does not stop.	Faulty electrical controls.	Consult an approved Dealer.
Direction indicators flashing more quickly.	Blown rear bulb.	➔ 356
The indicators are not working.	Faulty electrical circuit or control. Fuse damaged.	Consult an approved Dealer. Replace the fuse or have it replaced ➔ 368.
The headlights do not switch on or off.	Faulty electrical circuit or control. Fuse damaged.	Consult an approved Dealer. Replace the fuse or have it replaced ➔ 368.
Traces of condensation in the headlights or rear lights.	Traces of condensation may be a natural phenomenon caused by variations in temperature and humidity. In this case, the traces will gradually disappear once the lights are switched on.	
The front seat belt reminder warning light comes on when the seat belts are fastened.	An object is stuck between the floor and the seat and is disrupting the operation of the sensor.	Remove all objects from underneath the front seats.

INFORMATION ABOUT THE VEHICLE

Ensure that the label **A** is always visible and present on the windscreen as well as the rear screen.

Any modification or damage would prevent access to the information.



Engine identification, engine specifications

Engine identification

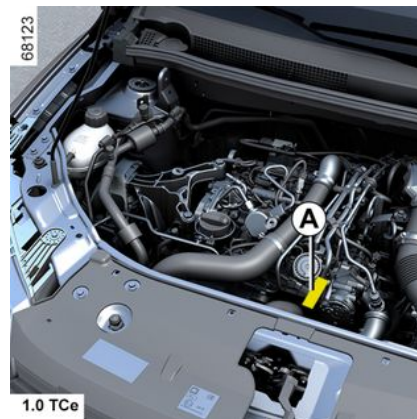
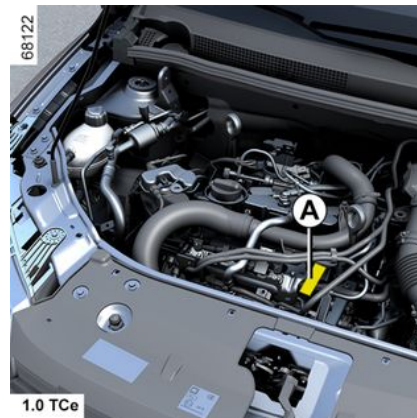
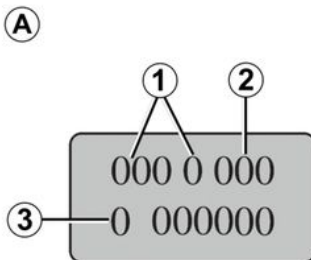

Please quote the engine identification information in area A in all correspondence or orders.

(Location varies depending on engine)

1. Engine type.
2. Engine suffix.
3. Engine serial number.

INFORMATION ABOUT THE VEHICLE

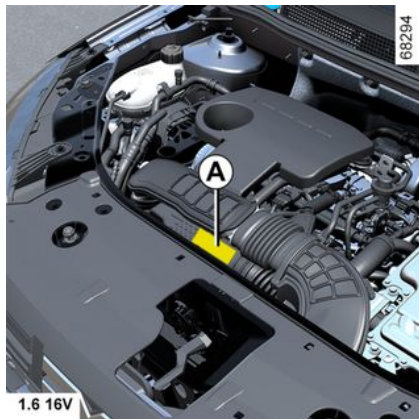
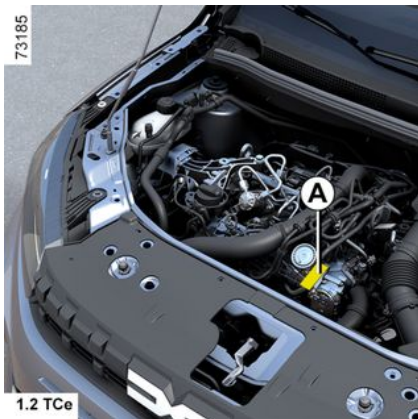
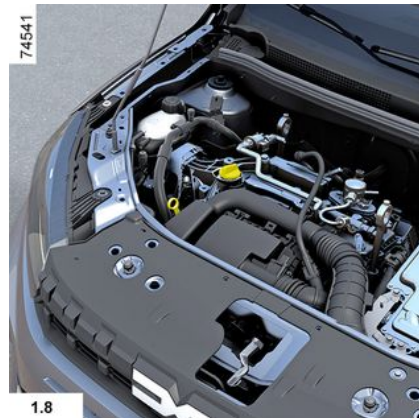

7





INFORMATION ABOUT THE VEHICLE

Engine specifications

Versions	1.0 12V	1.0 TCe		1.2 TCe	Hybrid			1.5 dCi
Engine type (see engine plate)	B4D	H4Dt	H5D	H5Ft	H4M	H5P	5DH	K9K Turbo
Cubic capacity (cc)	999			1 198	1598	1 793	-	1 461
Type of fuel Octane rating	Petrol It is essential to use unleaded petrol with an octane rating matching that indicated on the label affixed on the fuel filler flap ➔ 154.						-	Diesel The label located in the fuel filler flap indicates the authorised fuels.
Spark plugs	Only use the spark plugs specified for your vehicle's engine. The type should be marked on a label stuck inside the engine compartment. If it is not then contact your Approved Dealer. Fitting spark plugs which are not to specification may damage the engine.						-	-

INFORMATION ABOUT THE VEHICLE

Engine specifications

Versions	1.0 12V	1.0 TCe		1.2 TCe	Hybrid			1.5 dCi	
Engine type (see engine plate)	B4D	H4Dt	H5D	H5Ft	H4M	H5P	5DH	K9K	
Cubic capacity (cc)	999		1 198	1 598	1 793	-		1 461	
Fuel types that meet European standards and are compatible with the engines of vehicles sold in Europe (in any other case, contact an Approved Dealer).	 		Unleaded petrol compliant with standard EN 228 containing up to 5% ethanol in volume.			-		  	Diesel fuel compliant with standard EN 590 containing up to 7% fatty acid methyl ester in volume.
			Unleaded petrol compliant with standard EN 228 containing up to 10% ethanol in volume.						Diesel fuel compliant with standard EN 16734 containing up to 10% fatty acid methyl ester in volume.
Paraffinic Diesel fuel compliant with standard EN 15940 containing up to 7% fatty acid methyl ester in volume.									

7

INFORMATION ABOUT THE VEHICLE

Dimensions (in metres)

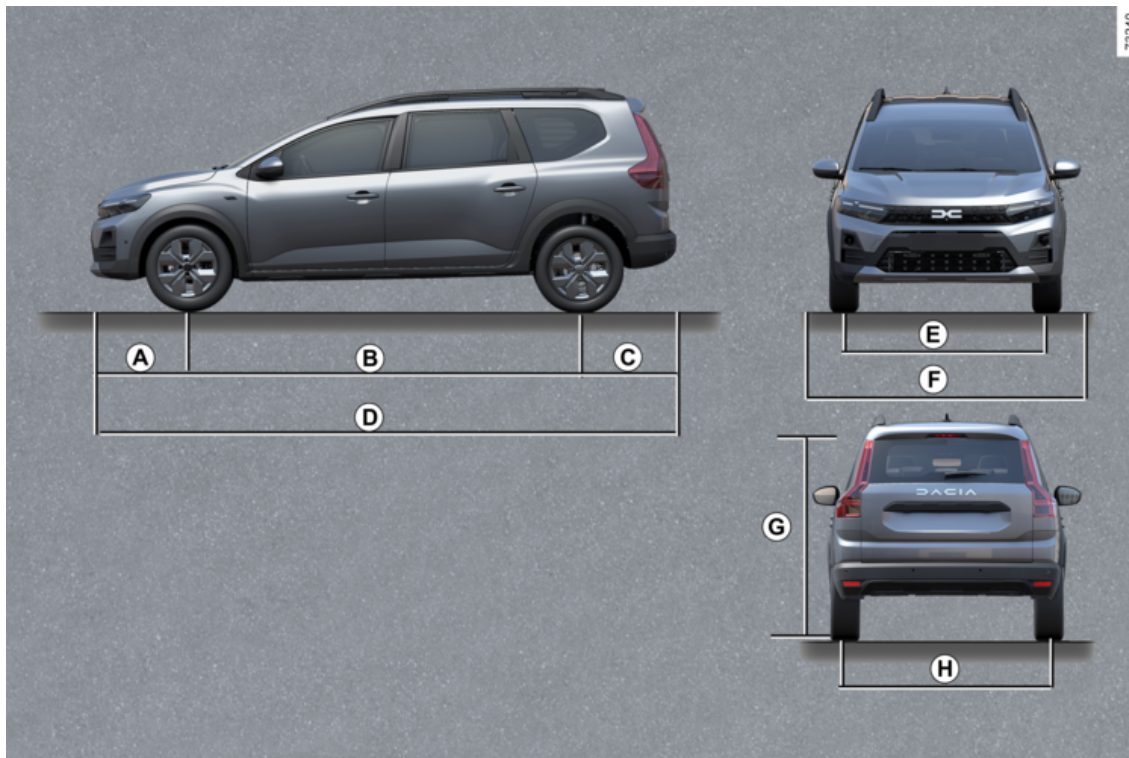

INFORMATION ABOUT THE VEHICLE

	Estate version with five or seven seats
A	0.830
B	2.898
C	0.819
D	4.574
E	1.520
F	1.848 to 2.007 – 1.848 with door mirrors folded in; – 2.007 with door mirrors folded out.
G	1.674 to 1.690 – 1.674 unladen; – 1.690 unladen, with aerial;
H	1.520

7

INFORMATION ABOUT THE VEHICLE

Weights (in kg)

The weights indicated are for a basic vehicle without optional extras : they vary according to your vehicle's equipment. Consult an Approved Dealer.

Estate versions	
Maximum Permissible All-up Weight (MMAC) Maximum Permissible Weight (MMTA) Gross Train Weight (MTR)	Weights indicated on the vehicle identification plate. → 378
Braked Towing Weight *	found by calculating: MTR - MMAC
Unbraked Towing Weight *	630 kg
Permissible nose weight *	75 kg
Maximum permissible load on roof	→ 313

* Towing weight (towing a caravan, boat, etc.)

Towing is prohibited when the MTR - MMAC calculation is equal to zero, or when the MTR is equal to zero (or is not listed) on the identification plate.

- It is important to respect local towing regulations in force, specifically those set out in the Highway Code. Contact an Approved Dealer for any modifications to towing equipment.
- For vehicles fitted with a trailer, **the total train weight (vehicle + trailer) must never be exceeded**. However the following is tolerated:
 - rear MMTA exceeded by no more than 15%,
 - the MMAC exceeded by no more than 10% or 100 kg (whichever limit is reached first).

In either case, the maximum speed of the vehicle and trailer must not exceed 62 mph (100 km/h) and the tyre pressures must be increased by 0.2 bar (3 psi).

- The engine output and climbing capability are reduced with altitude. We recommend that the maximum load be reduced by 10% at an altitude of 1,000 metres and by an additional 10% for each 1,000 metres thereafter.

REPLACEMENT PARTS AND REPAIRS

Original parts are based on very stringent specifications and are subjected to specific tests. Therefore, they are of at least the same level of quality as the parts fitted originally.

If you always fit genuine replacement parts to your vehicle, you will ensure that it performs well. Furthermore, repairs carried out in the approved dealer network with original parts are guaranteed according to the conditions stated on the back of the repair order.

SERVICE SHEETS

VIN:

Date:	Miles (km):	Invoice number:	Comments/miscellaneous
Type of operation: Service <input type="checkbox"/> <input type="checkbox"/>		Stamp	
Anticorrosion check: OK <input type="checkbox"/> Not OK* <input type="checkbox"/>			
Date:	Miles (km):	Invoice number:	Comments/miscellaneous
Type of operation: Service <input type="checkbox"/> <input type="checkbox"/>		Stamp	
Anticorrosion check: OK <input type="checkbox"/> Not OK* <input type="checkbox"/>			
Date:	Miles (km):	Invoice number:	Comments/miscellaneous
Type of operation: Service <input type="checkbox"/> <input type="checkbox"/>		Stamp	
Anticorrosion check: OK <input type="checkbox"/> Not OK* <input type="checkbox"/>			

* See specific page

SERVICE SHEETS

VIN:

Date:	Miles (km):	Invoice number:	Comments/miscellaneous
Type of operation:		Stamp	
Service <input type="checkbox"/>			
..... <input type="checkbox"/>			
Anticorrosion check:			
OK <input type="checkbox"/> Not OK* <input type="checkbox"/>			
Date:	Miles (km):	Invoice number:	Comments/miscellaneous
Type of operation:		Stamp	
Service <input type="checkbox"/>			
..... <input type="checkbox"/>			
Anticorrosion check:			
OK <input type="checkbox"/> Not OK* <input type="checkbox"/>			
Date:	Miles (km):	Invoice number:	Comments/miscellaneous
Type of operation:		Stamp	
Service <input type="checkbox"/>			
..... <input type="checkbox"/>			
Anticorrosion check:			
OK <input type="checkbox"/> Not OK* <input type="checkbox"/>			

* See specific page

7

SERVICE SHEETS

VIN:

Date:	Miles (km):	Invoice number:	Comments/miscellaneous
Type of operation: Service <input type="checkbox"/> <input type="checkbox"/>		Stamp	
Anticorrosion check: OK <input type="checkbox"/> Not OK* <input type="checkbox"/>			
Date:	Miles (km):	Invoice number:	Comments/miscellaneous
Type of operation: Service <input type="checkbox"/> <input type="checkbox"/>		Stamp	
Anticorrosion check: OK <input type="checkbox"/> Not OK* <input type="checkbox"/>			
Date:	Miles (km):	Invoice number:	Comments/miscellaneous
Type of operation: Service <input type="checkbox"/> <input type="checkbox"/>		Stamp	
Anticorrosion check: OK <input type="checkbox"/> Not OK* <input type="checkbox"/>			

* See specific page

SERVICE SHEETS

VIN:

Date:	Miles (km):	Invoice number:	Comments/miscellaneous
Type of operation:		Stamp	
Service <input type="checkbox"/>			
..... <input type="checkbox"/>			
Anticorrosion check:			
OK <input type="checkbox"/> Not OK* <input type="checkbox"/>			
Date:	Miles (km):	Invoice number:	Comments/miscellaneous
Type of operation:		Stamp	
Service <input type="checkbox"/>			
..... <input type="checkbox"/>			
Anticorrosion check:			
OK <input type="checkbox"/> Not OK* <input type="checkbox"/>			
Date:	Miles (km):	Invoice number:	Comments/miscellaneous
Type of operation:		Stamp	
Service <input type="checkbox"/>			
..... <input type="checkbox"/>			
Anticorrosion check:			
OK <input type="checkbox"/> Not OK* <input type="checkbox"/>			

* See specific page

7

SERVICE SHEETS

VIN:

Date:	Miles (km):	Invoice number:	Comments/miscellaneous
Type of operation: Service <input type="checkbox"/> <input type="checkbox"/>		Stamp	
Anticorrosion check: OK <input type="checkbox"/> Not OK* <input type="checkbox"/>			
Date:	Miles (km):	Invoice number:	Comments/miscellaneous
Type of operation: Service <input type="checkbox"/> <input type="checkbox"/>		Stamp	
Anticorrosion check: OK <input type="checkbox"/> Not OK* <input type="checkbox"/>			
Date:	Miles (km):	Invoice number:	Comments/miscellaneous
Type of operation: Service <input type="checkbox"/> <input type="checkbox"/>		Stamp	
Anticorrosion check: OK <input type="checkbox"/> Not OK* <input type="checkbox"/>			

* See specific page

SERVICE SHEETS

VIN:

Date:	Miles (km):	Invoice number:	Comments/miscellaneous
Type of operation:		Stamp	
Service <input type="checkbox"/>			
..... <input type="checkbox"/>			
Anticorrosion check:			
OK <input type="checkbox"/> Not OK* <input type="checkbox"/>			
Date:	Miles (km):	Invoice number:	Comments/miscellaneous
Type of operation:		Stamp	
Service <input type="checkbox"/>			
..... <input type="checkbox"/>			
Anticorrosion check:			
OK <input type="checkbox"/> Not OK* <input type="checkbox"/>			
Date:	Miles (km):	Invoice number:	Comments/miscellaneous
Type of operation:		Stamp	
Service <input type="checkbox"/>			
..... <input type="checkbox"/>			
Anticorrosion check:			
OK <input type="checkbox"/> Not OK* <input type="checkbox"/>			

* See specific page

7

ANTICORROSION CHECK

If the continuation of the warranty is subject to repair, it is indicated below.

VIN:

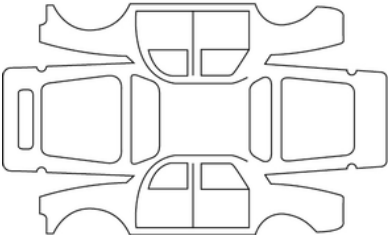
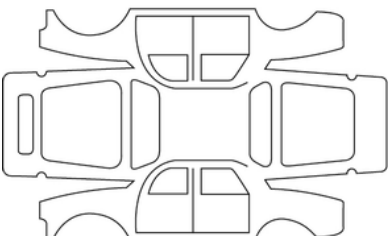
Date of repair:		Stamp
Corrosion repair operation to be carried out:		
Date of repair:		Stamp
Repair to be carried out:		

ANTICORROSION CHECK

If the continuation of the warranty is subject to repair, it is indicated below.

VIN:

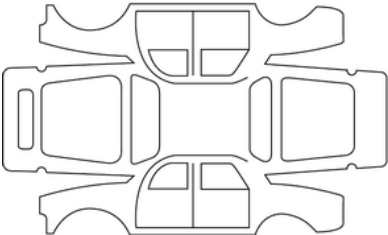
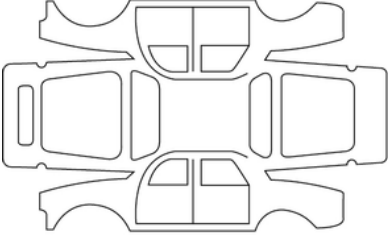
Date of repair:		Stamp
Corrosion repair operation to be carried out:		
Date of repair:		Stamp
Repair to be carried out:		

7

ANTICORROSION CHECK

If the continuation of the warranty is subject to repair, it is indicated below.

VIN:

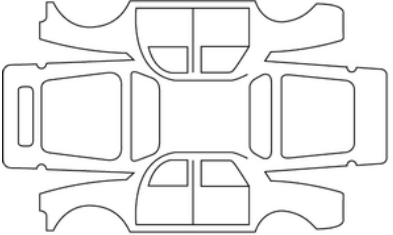
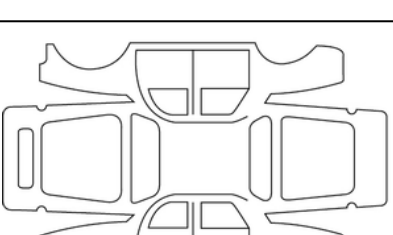
Date of repair:		Stamp
Corrosion repair operation to be carried out:		
Date of repair:		Stamp
Repair to be carried out:		

ANTICORROSION CHECK

If the continuation of the warranty is subject to repair, it is indicated below.

VIN:

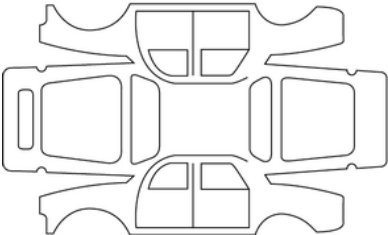
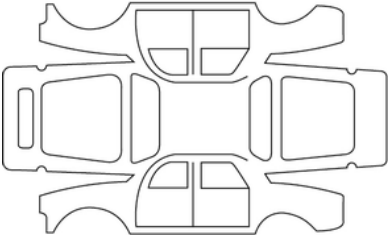
Date of repair:		Stamp
Corrosion repair operation to be carried out:		
Date of repair:		Stamp
Repair to be carried out:		

7

ANTICORROSION CHECK

If the continuation of the warranty is subject to repair, it is indicated below.

VIN:

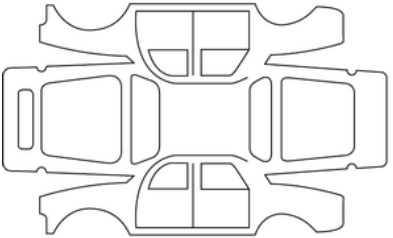
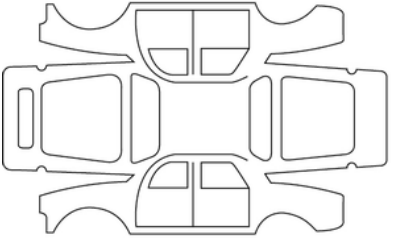
Date of repair:		Stamp
Corrosion repair operation to be carried out:		
Date of repair:		Stamp
Repair to be carried out:		

ANTICORROSION CHECK

If the continuation of the warranty is subject to repair, it is indicated below.

VIN:

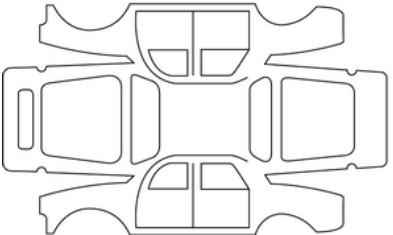
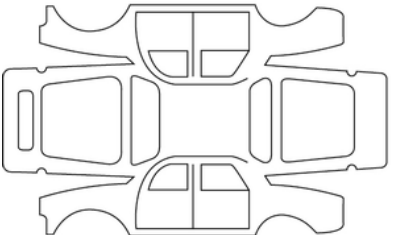
Date of repair:		Stamp
Corrosion repair operation to be carried out:		
Date of repair:		Stamp
Repair to be carried out:		

7

ANTICORROSION CHECK

If the continuation of the warranty is subject to repair, it is indicated below.

VIN:

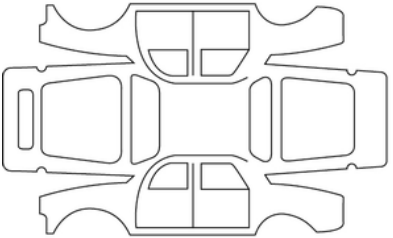
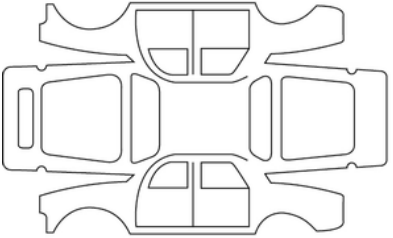
Date of repair:		Stamp
Corrosion repair operation to be carried out:		
Date of repair:		Stamp
Repair to be carried out:		

ALPHABETICAL INDEX

Symbols

"Hands-free" card: battery, [43](#), [43](#)

"Hands-free" card: use, [39](#)

A

ABS, [208](#)

Accessories socket, [301](#)

Access to the engine compartment, [319](#)

Active emergency braking, [231](#)

Additional lights, [355](#)

Additional restraint devices, [81](#)

Additive (reagent), [157](#)

Additive tank capacity, [157](#)

Adjusting the front seats, [57](#)

Adjusting your driving position, [66](#)

Airbag, [72](#), [77](#), [77](#), [81](#)

Airbag : activating the front passenger airbag, [105](#)

Airbag : deactivating the front passenger airbag, [105](#)

Airbag inflatable cushion, [72](#), [77](#), [81](#)

Airbags : child safety, [105](#)

Air conditioning, [281](#), [281](#), [285](#), [285](#), [288](#), [288](#)

Air conditioning: information and advice for use, [288](#)

Air vents, [278](#), [280](#)

Anti-corrosion protection, [331](#)

Anti-lock braking system: ABS, [208](#)

Anti-theft (switch), [161](#)

Armrest, [303](#)

Ashtray, [301](#)

Ashtrays, [301](#)

Assisted parking, [259](#)

Audible alarm, [50](#)

Audible and visual signals, [147](#)

Automatic gearbox (use), [172](#), [175](#), [180](#)

Automatic gearbox selector lever, [172](#), [175](#)

Automatic locking when driving, [54](#)

B

Batteries, [43](#)

Battery, [327](#)

Battery: troubleshooting, [351](#)

Battery (remote control), [48](#)

Battery breakdown recovery, [351](#)

Blind spot: warning, [222](#)

Blind spot warning, [222](#)

Bonnet, [319](#)

Breakdown recovery towing, [348](#), [350](#)

Bulbs replacement, [355](#), [360](#)

C

Card: battery, [43](#)

Card: emergency key, [37](#)

Card: engine not starting in hands-free mode, [37](#)

Card: hands-free, [37](#)

Card: locking/unlocking the opening elements, [37](#)

Card: use, [37](#), [39](#)

Card emergency key, [51](#)

ALPHABETICAL INDEX

Catalytic converter, [187](#)
Central door locking, [51](#), [129](#)
Changing a wheel, [345](#)
Changing bulbs, [355](#), [360](#)
Changing gears, [172](#)
Child restraint, [82](#)
Child restraint devices, [82](#)
Child restraint system, [82](#)
Child safety, [47](#), [82](#)
Child seat height adjustment, [82](#)
Child seats, [82](#), [88](#)
Cigarette lighter, [301](#)
Cleaning: vehicle interior, [333](#)
Closing the doors, [50](#), [51](#)
Configuration menu, [129](#)
Configuration menu settings, [129](#)
Control instruments, [112](#), [124](#), [132](#), [142](#)
Controls, [251](#), [254](#)
Control warning lights, [112](#), [124](#), [132](#)
Coolant level, [324](#)
Courtesy light, [298](#), [360](#)
Cruise control, [254](#)
Cruise control - speed limiter, [251](#), [254](#)
Customising vehicle settings, [129](#)

D

Daytime running lights, [129](#)
De-icing/demisting the windscreen, [285](#)

Demisting the rear window, [285](#)
Detection of pedestrians, [231](#)
Detection of vehicles, [231](#)
Display, [124](#)
Door locking remote control batteries, [48](#)
Doors, [50](#), [54](#), [129](#)
Doors/luggage compartment door, [37](#), [39](#), [47](#)
Driver's position, [108](#)
Driver assistance, [208](#), [222](#), [227](#), [231](#), [251](#), [254](#), [259](#), [263](#)
Driving, [129](#), [161](#), [162](#), [165](#), [172](#), [175](#), [180](#), [185](#), [187](#), [192](#),
[202](#), [208](#), [222](#), [227](#), [231](#), [251](#), [254](#), [259](#), [263](#)
Driving advice, [192](#)
Driving aids, [129](#), [222](#), [227](#), [231](#), [251](#), [254](#), [259](#), [263](#)
Driving position settings, [66](#)

E

ECO driving, [132](#), [192](#)
ECO mode, [192](#)
Electronic parking brake, [180](#)
Electronic stability program: ESC, [208](#)
Emergency brake assist, [208](#)
Emergency braking, [208](#), [231](#)
Emergency key, [37](#)
Emergency spare wheel, [343](#)
Emission control advice, [191](#), [191](#)
Engine identification, [379](#)
Engine oil, [320](#), [321](#)
Engine oil dipstick, [320](#), [321](#)

ALPHABETICAL INDEX

Engine oil grade, [321](#)
Engine oil level, [320](#), [321](#)
Engine specifications, [379](#)
Engine start/stop button, [165](#)
Environment, [189](#)
ESC: Electronic stability program, [208](#)
Excessive speed warning, [251](#)
Extended grip, [208](#)
Exterior lighting and signals, [142](#)
Exterior lights, [355](#)

F

Filter: particle filter, [185](#), [187](#)
Fitting a child seat, [88](#)
Fittings, [303](#)
Front headrests, [57](#)
Front seat adjustment, [57](#)
Front seats, [57](#)
Fuel consumption, [192](#)
Fuel economy, [192](#)
Fuel tank, [154](#)
Fuel Tips for reducing consumption, [192](#)
Fuses, [368](#)

G

Gear control, [172](#)
Gear lever, [172](#)
Glovebox, [303](#)

GPL, [31](#)
Grab handle, [300](#)

H

Handbrake, [172](#), [180](#)
Hands-free telephone integrated control, [291](#)
Hazard signal, [147](#)
Headlights, [142](#)
Headrests, [57](#)
Heated seats, [57](#)
Heated windscreen, [285](#)
Heating and air conditioning system, [278](#), [280](#), [281](#), [285](#)
Heating system, [278](#), [280](#), [281](#), [285](#), [288](#)
Hill start assist, [208](#)
Horn, [147](#), [147](#)
Hubcap tool, [341](#)

I

Ignition switch, [161](#), [180](#)
Indicators, [147](#)
Indicators: direction indicators, [147](#)
Instrument panel, [112](#), [129](#), [132](#), [168](#), [180](#), [202](#)
Instrument panel warning lights, [112](#), [168](#), [180](#)
Interior lighting, [298](#)
Interior lighting: changing bulbs, [360](#)
Interior trim maintenance, [333](#)

ALPHABETICAL INDEX

J

Jack, [341](#), [345](#)

K

Key/radio frequency remote control: use, [47](#)

Key/Remote control, [45](#)

Keys, [45](#), [47](#)

L

Levels, [319](#), [320](#), [325](#)

Levels: coolant, [324](#)

Lighting: interior, [298](#), [360](#)

Lighting: see-me-home lighting, [129](#)

Lighting signals, [142](#)

Lights: dipped beam headlights, [355](#)

Lights: direction indicator lights, [147](#), [355](#)

Lights: exterior, [142](#), [355](#)

Lights: hazard warning lights, [147](#)

Lights: main beam headlights, [355](#)

Lights: replacing bulbs, [355](#)

Lights: side lights, [355](#)

Locking, [66](#)

Locking/unlocking the opening elements: doors, [51](#)

Locking remote control, [45](#)

Locking the doors, [37](#), [39](#), [47](#), [129](#)

LPG, [154](#), [162](#), [165](#)

Luggage compartment, [56](#)

Luggage cover, [309](#)

M

Maintenance, [191](#)

Maintenance: bodywork, [331](#)

Maintenance: filters, [325](#)

Maintenance: interior trims, [333](#)

Maintenance: mechanical, [320](#), [325](#)

Manual air conditioning, [281](#)

Messages on the instrument panel, [112](#), [168](#), [180](#), [202](#)

Methods of restraint in addition to the front seat belts, [72](#)

Mirrors, [300](#)

Multimedia equipment, [129](#), [291](#)

Multimedia port(s), [291](#)

Multimedia screen screens, [222](#), [227](#), [231](#), [259](#), [263](#)

N

Navigation, [291](#)

Navigation system, [291](#)

O

Oil change, [321](#)

On-board computer, [129](#)

Opening elements, [50](#), [54](#)

Opening the doors, [50](#), [51](#)

Operating faults, [54](#), [81](#), [148](#), [168](#), [175](#), [175](#), [180](#), [180](#), [231](#), [231](#)

Operating faults: card batteries, [37](#)

Operation, [175](#)

ALPHABETICAL INDEX

P

Paintwork maintenance, [331](#)
Park Assist: assisted parking, [259](#)
Parking brake, [180](#)
Parking distance control, [129](#), [259](#)
Passenger safety: front passenger airbag, [105](#)
Pedestrian horn, [24](#)
Power-assisted steering, [138](#), [138](#)
Power consumption, [124](#)
Practical advice, [355](#), [360](#), [368](#)
Pretensioners, [72](#)
Puncture, [341](#), [343](#), [345](#)
Puncture: emergency spare wheel, [343](#)
Put the engine on standby, [168](#)

R

Radio, [291](#)
Reagent (tank), [157](#)
Reagent filling, [157](#)
Reagent grade, [157](#)
Reagent tank, [157](#)
Reagent tank cap, [157](#)
Reagent tank capacity, [157](#)
Rear bench seat, [61](#)
Rear seats, [59](#)
Rear seats functions, [61](#)
Rear view mirrors, [140](#)
Remote control for central locking doors, [47](#)

Remote engine start-up, [37](#)
Replacement and repair parts, [386](#)
Replacement bulbs, [355](#), [360](#)
Replacing windscreen wiper blades, [366](#)
Restraint devices in addition to the rear seat belts, [77](#)
Restraint in addition to the seatbelts, [72](#), [77](#), [77](#), [81](#)
Reversing camera, [259](#)
Roof bars, [313](#)
Running in, [161](#)

S

Safe distance alert, [227](#)
Safe distances, [227](#)
SCR: selective catalytic reduction, [157](#)
Screen washer, [148](#), [152](#), [325](#)
Seat belt pretensioners, [77](#)
Seat belts, [66](#), [72](#), [77](#), [81](#), [333](#)
Selecting reverse gear, [172](#)
Settings, [129](#)
Side protection devices, [77](#), [77](#)
Special feature of diesel vehicles, [185](#)
Special features of GPL versions, [31](#)
Special features of petrol vehicles, [187](#)
Speed limiter, [251](#)
Spotlights, [298](#)
Starting, [162](#)
Starting the engine, [161](#), [162](#), [162](#), [165](#), [165](#), [168](#)
Steering wheel adjustment, [138](#)

ALPHABETICAL INDEX

Stop and Start function, [168](#), [180](#)
Stopping the engine, [162](#), [180](#)
Storage compartment, [303](#)
Storage compartment/fittings: passenger compartment, [303](#)
Storage compartments, [303](#)
Sun visor, [300](#)
Switching fuel while driving, [31](#)

T

Tailgate, [56](#)
Telephone, [291](#)
Temperature regulation, [285](#), [288](#)
Tools, [341](#)
Tow eyes, [348](#)
Towing rings, [341](#), [350](#)
Traction control, [208](#), [208](#)
Traction control - Extended grip, [208](#)
Transporting children, [82](#)
Trip computer, [112](#)
Troubleshooting: battery, [351](#)
Tyre inflation, [197](#), [202](#), [337](#), [341](#)
Tyre inflation kit, [197](#), [202](#), [341](#), [343](#)
Tyre pressure, [197](#), [202](#), [337](#), [343](#)
Tyre pressure loss warning, [202](#)
Tyre pressure monitoring system, [197](#)
Tyres, [197](#), [202](#), [335](#)
Tyres: tyre pressure monitoring system, [197](#)

U

Unlocking the doors, [51](#)
User precautions, [148](#)

V

Vehicle customisation settings, [129](#)
Vehicle settings personalisation menu, [129](#)
Ventilation, [285](#), [288](#)
Ventilation air conditioning, [281](#)
Visual signals, [147](#)

W

Warning, [147](#)
Warning lights, [222](#)
Warning lights on the instrument panel, [202](#)
Washing, [331](#)
Wheelbrace, [341](#), [345](#)
Wheel trims, [346](#)
Windscreen demisting, [285](#)
Windscreen washer reservoir, [325](#)
Wiper/washer, [148](#), [366](#)
Wiper/washer replacement of blades, [148](#), [366](#)
Wiper blades, [148](#)
Wiper blades: replacement, [366](#)
Wipers, [148](#)
Wipers/washer, [129](#)

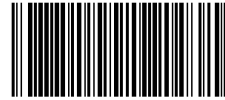

7799002725

Réf 7799002725 / Edition anglaise
NU 1689-2 – 04/2026

